

CERTIFICATE

Quality Austria Training, Certification and Evaluation Ltd. awards this Quality Austria Certificate to the following organisation(s):

This Quality Austria Certificate confirms the application and further development of an effective



**FABRIKA AUTOMOBILSKIH
DELOVA FAD AD**
Serbia - 32300 Gornji Milanovac Kneza Aleksandra 210

QUALITY MANAGEMENT SYSTEM
complying with the requirements of standard
ISO 9001:2008

Quality Austria Training, Certification and Evaluation Ltd. is accredited according to the Austrian Accreditation Act by the BMWA (Federal Ministry of Economic Affairs and Labour).

Quality Austria is accredited as an organization for environmental verification by the BMLFUW (Federal Ministry of Agriculture, Forestry, Environment and Water Management).

Quality Austria is authorized by the VDA (Association of the Automotive Industry).

For accreditation and registration details please refer to the applicable regulations and decisions published in the Federal Law Gazette or recognition documents.

Quality Austria is the Austrian member of IQNet (International Certification Network).

Doc. No. FO_24_002

AAB71EF5-8668-434A-92
OC-88E4F2D6F387

The current validity of the certificate is documented exclusively on the Internet under <http://www.qualityaustria.com/index.php?id=798&L=1> EAC: 22.1

Scope of application:
steering and suspension parts production

Registration No.: 08606/0
Date of initial issue: 25 November 2009
Valid until: 24 November 2012

Vienna, 25 November 2009

Quality Austria Training,
Certification and Evaluation Ltd.



 **qualityaustria**



Signatures removed for security reasons

Konrad Scheiber
General Manager

Ing. Wolfgang Leitner
Specialist representative



CERTIFICATE

Quality Austria Training, Certification and Evaluation Ltd. awards this Quality Austria Certificate to the following organisation(s):

This Quality Austria Certificate confirms the application and further development of an effective



**FABRIKA AUTOMOBILSKIH
DELOVA FAD AD**
Serbia - 32300 Gornji Milanovac Kneza Aleksandra 210

QUALITY MANAGEMENT SYSTEM
complying with the requirements of standard
ISO/TS 16949:2009,
without product design

Quality Austria Training, Certification and Evaluation Ltd. is accredited as an organization for environmental verification by the BMLFUW (Federal Ministry of Agriculture, Forestry, Environment and Water Management).

Quality Austria is authorized by the VDA (Association of the Automotive Industry).

For accreditation and registration details please refer to the applicable regulations and decisions published in the Federal Law Gazette or recognition documents.

Quality Austria is the Austrian member of IQNet (International Certification Network).

Doc. No. FO_24_004

D78E306A-348C-4AB2-85
BC-E06A083D2E9F

Scope of application:
steering and suspension parts production

Registration No.: 01572/0
IATF-Registration No.: 0092481
Date of initial issue: 25 November 2009
Valid until: 24 November 2012

Vienna, 25 November 2009

Quality Austria Training,
Certification and Evaluation Ltd.

 **qualityaustria**



Signatures removed for security reasons

Konrad Scheiber
General Manager

Gerald Perschler
Specialist representative



**Fabrika automobilskih delova
"FAD" A.D. Gornji Milanovac
Srbija**

**KATALOG PROIZVODA
CATALOGUE OF PRODUCTS
WARENKATALOG**

**2010. GODINA
I IZDANJE**

**Fabrika automobilskih delova "FAD" A.D.
Ul. Kneza Aleksandra 210
32300 Gornji Milanovac, Srbija**

**Centrala: ++381 32 725 290 -296, 725 255
Prodaja: ++381 32 725 394
Izvoz: ++381 32 725 393
Telefax: ++381 32 725 453/ 725 163/ 725 878
E-mail: sales@fad.rs
www.fad.rs**

SADRZAJ

APLICATION GUIDE

ANWENDUNGSLISTE

UPUTSTVO/ ERKLÄRUNG/ EXPLANATION.....	1-4
DAF.....	5-14
FAUN.....	15-17
IVECO.....	18-34
KÄSSBOHRER.....	35-39
LIEBHERR.....	40-42
MAN.....	43-66
MERCEDES-BENZ.....	67-126
RABA.....	127-133
RENAULT.....	134-147
SCANIA.....	148-157
VOLVO.....	158-175
PREGLED UPOREDNIH OZNAKA FAD/ ORG. BROJ/ THE SURVEY OF PARALLEL NUMBERS FAD/ ORG. NR....	176-223

UPUTSTVO
ERKLÄRUNG
EXPLANATION

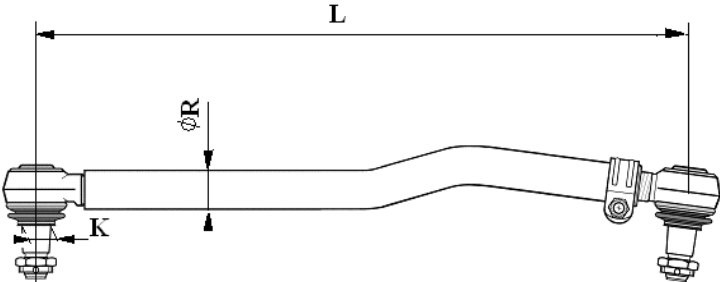
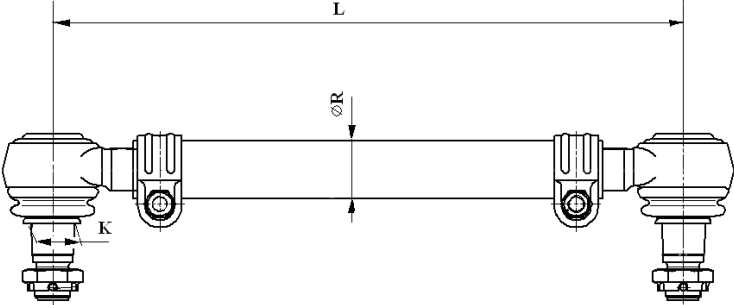
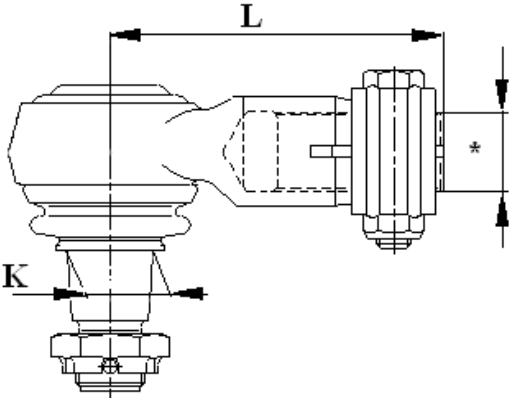

Skica Benennung Description	Simbol Symbole Symbols	Objasnjenje Erklärung Explanation
<p>Spona upravljača Lenkstange Drag link</p> 	<p>Kugla Ball Ø Größe</p> <p>ØR</p> <p>L</p> <p>K</p>	<p>-Precnik kugle Kugel-Durchmesser Ball pin diameter</p> <p>-Precnik cevi Rohr durchmesser Tube diameter</p> <p>-Duzina spona Längenmass von mitte bis mitte Distance center to center distance</p> <p>-Max. precnik konusa Größtmass am konus Taper Ø max. size</p>
<p>Poprecna spona Spurstange Tie rod</p> 	<p>Kugla Ball Ø Größe</p> <p>ØR</p> <p>L</p> <p>K</p>	<p>-Precnik kugle Kugel-Durchmesser Ball pin diameter</p> <p>-Precnik cevi Rohr durchmesser Tube diameter</p> <p>-Duzina spona Längenmass von mitte bis mitte Distance center to center distance</p> <p>-Max. precnik konusa Größtmass am konus Taper Ø max. size</p>
<p>Zglob sa untrasnjim navojem Kugelgelenk Tie rod end</p> 	<p>Kugla Ball Ø Größe</p> <p>L</p> <p>K</p> <p>*</p>	<p>-Precnik kugle Kugel-Durchmesser Ball pin diameter</p> <p>-Duzina zgloba Kugelgelenk länge Tie rod end lenght</p> <p>-Max. precnik konusa Größtmass am konus Taper Ø max. size</p> <p>-Untrasnji navoj Innengewinde Internal thread</p>

UPUTSTVO
ERKLÄRUNG
EXPLANATION



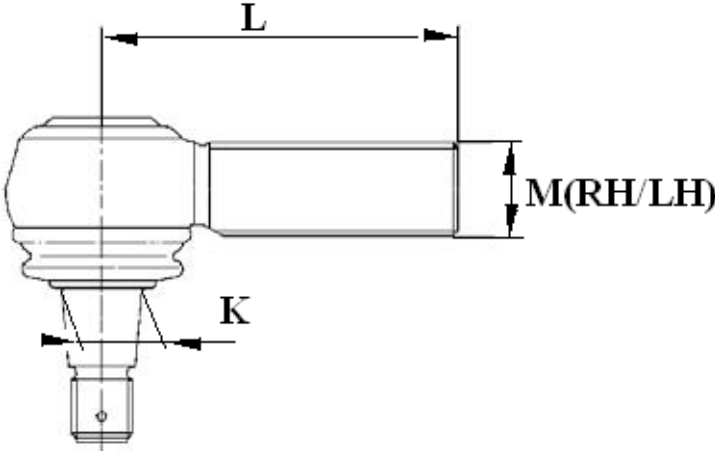
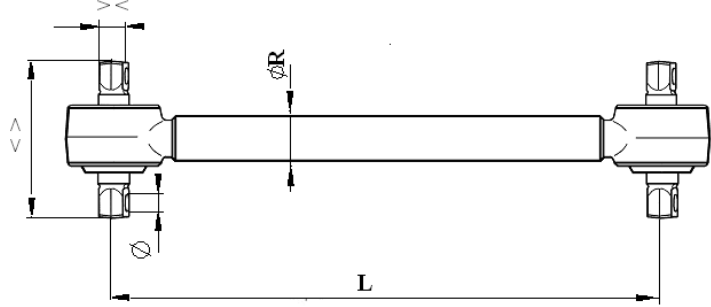

Skica Benennung Description	Simbol Symbole Symbols	Objasnjenje Erklärung Explanation
<p>Zglob Kugelgelenk Tie rod end</p> 	<p>Kugla Ball Ø Größe</p> <p>L</p> <p>K</p> <p>M</p> <p>RH</p> <p>LH</p>	<p>-Prečnik kugle Kugel-Durchmesser Ball pin diameter</p> <p>-Duzina zgloba Kugelgelenk länge Tie rod end lenght</p> <p>-Max. prečnik konusa Größtmass am konus Taper Ø max. size</p> <p>-Metricki navoj Metrisches gewinde ISO Thread-metrie</p> <p>-Desni navoj Rechtsgewinde Right hand thread</p> <p>-Levi navoj Linksgewinde Left hand thread</p>
<p>Vodjica mosta Achsstrebe Torque rod</p> 	<p>Kugla Ball Ø Größe</p> <p>ØR</p> <p>L</p> <p>Ø</p> <p>> <</p> <p>< ></p>	<p>-Prečnik kugle Kugel-Durchmesser Ball pin diameter</p> <p>-Prečnik cevi Rohr durchmesser Tube diameter</p> <p>-Duzina vodjice mosta Längenmass von mitte bis mitte Distance center to center distance</p> <p>-Prečnik otvora Bohrungs-durchmesser Bore Ø</p> <p>-Debljina flaha Breite Broad</p> <p>-Rastojanje izmedju otvora Lochabstand Hole distance</p>

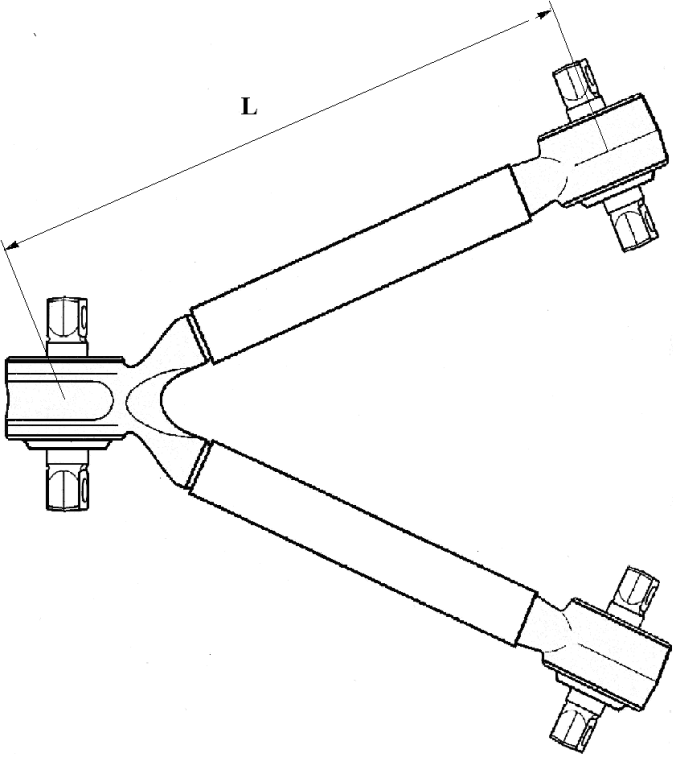
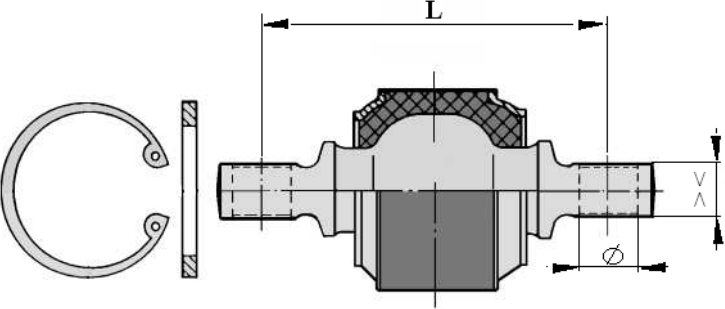
UPUTSTVO
ERKLÄRUNG
EXPLANATION

<p>Skica Benennung Description</p>	<p>Simbol Symbole Symbols</p>	<p>Objasnjenje Erklärung Explanation</p>
<p>V-vodjica mosta Dreieckslenker Triangular torque rod</p> 	<p>Kugla Ball Ø Größe</p> <p>ØR</p> <p>L</p> <p>Ø</p> <p>> <</p> <p>< ></p>	<p>-Precnik kugle Kugel-Durchmesser Ball pin diameter</p> <p>-Precnik cevi Rohr durchmesser Tube diameter</p> <p>-Duzina V-vodjice mosta Längenmass von mitte bis mitte Distance center to center distance</p> <p>-Precnik otvora Bohrungs-durchmesser Bore Ø</p> <p>-Debljina flaha Breite Broad</p> <p>-Rastojanje izmedju otvora Lochabstand Hole distance</p>
<p>Izmenljivi podsklop Rep.-satz, kugelstük, molekular Rep.-kit, with pivot pin, molecular</p> 	<p>Kugla Ball Ø Größe</p> <p>Ø</p> <p>> <</p> <p>< ></p>	<p>-Precnik kugle Kugel-Durchmesser Ball pin diameter</p> <p>-Precnik otvora Bohrungs-durchmesser Bore Ø</p> <p>-Debljina flaha Breite Broad</p> <p>-Rastojanje izmedju otvora Lochabstand Hole distance</p>

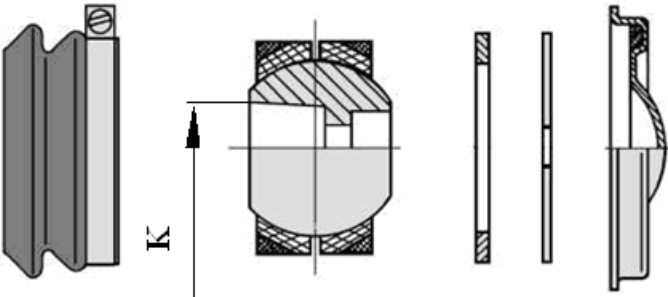
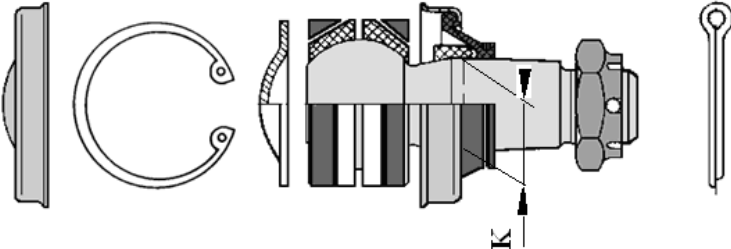
UPUTSTVO
ERKLÄRUNG
EXPLANATION

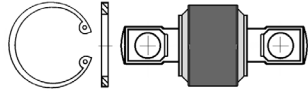
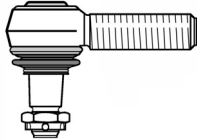
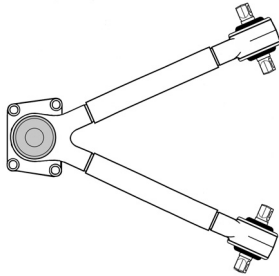
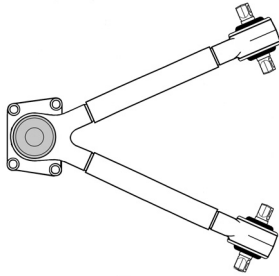
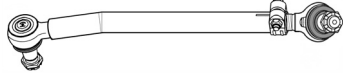
Skica Benennung Description	Simbol Symbole Symbols	Objasnjenje Erklärung Explanation
<p>Izmenljivi podsklop Rep.-satz, kugelhülse Rep.-kit, with ball housing</p> 	<p>Kugla Ball Ø Größe</p> <p>K</p>	<p>-Prečnik kugle Kugel-Durchmesser Ball pin diameter</p> <p>-Max. prečnik konusnog otvora Größtmass am innen-konus Taper hole Ø</p>
<p>Izmenljivi podsklop Rep.-satz, kugelzapfen Rep.-kit, with ball pin</p> 	<p>Kugla Ball Ø Größe</p> <p>K</p>	<p>-Prečnik kugle Kugel-Durchmesser Ball pin diameter</p> <p>- Max. prečnik konusa Größtmass am konus Taper Ø max. size</p>

Originalni broj Cross-Ref.-No. Original Nr.	Br. FAD No. Nr.	Naziv Designation Bezeichnung	Kugla Ball Ø Größe	Konus Taper Konus	Duzina Length Länge	Skica Figure Bild
0 067 354	5117.96.00	Izmenljivi podsklop Repair kit Reparatur satz	62	Ø19 >24<	<130>	
0 069 867 0 161 376 0 608 000 1 142 173	5742.20.00	Zglob,RH M30x1,5 Ball joint, RH Kugelgelenk, RH	40	K26	120	
0 080 521	3873.00.00	V Vodjica mosta Triangular torque rod Dreieckslenker Izmenljivi delovi Parts list Stuckliste 3873.96.00 3875.90.00	65/70	Ø23 >24< <152> K38	608 RØ50	
0 080 521 1 368 270 1 390 932 1 617 096	6770.00.00	V Vodjica mosta Triangular torque rod Dreieckslenker Izmenljivi delovi Parts list Stuckliste 6770.90.00 6771.96.00	65/62	Ø23 >24< <152> K38	608 RØ50	
0 094 016 0 171 215	5394.00.00	Spona upravljacka Drag link Lenkstange Izmenljivi delovi Parts list Stuckliste 5810.20.00	50/40	K30	725 RØ40	
0 094 029 0 117 343 94 029	5393.00.00	Spona upravljacka Drag link Lenkstange Izmenljivi delovi Parts list Stuckliste 5810.20.00	50/40	K30	860 RØ40	

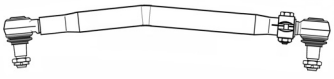
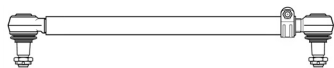
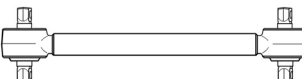
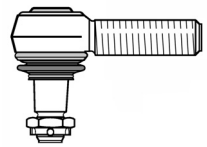
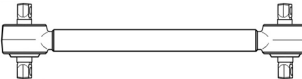
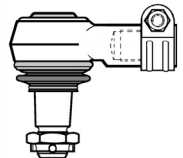
Originalni broj Cross-Ref.-No. Original Nr.	Br. FAD No. Nr.	Naziv Designation Bezeichnung	Kugla Ball Ø Größe	Konus Taper Konus	Duzina Length Länge	Skica Figure Bild
0 094 038 0 525 433	5392.00.00	Spona upravljača Drag link Lenkstange Izmenljivi delovi Parts list Stuckliste 5810.20.00	50/40	K30	1005 RØ52	
0 094 044 0 274 878 1 152 427	3889.00.00	Spona upravljača Drag link Lenkstange Izmenljivi delovi Parts list Stuckliste 5743.20.00	40	K30	1130 RØ40	
0 099 990 099 990	5385.00.00	Vodjica mosta Torque rod Achsstrebe Izmenljivi delovi Parts list Stuckliste 5323.96.00	62	Ø17 >24< <115>	665 RØ50	
0 110 197 0 607 451 0 607 453 1 228 114	5746.20.00	Zglob,RH M28x1,5 Ball joint, RH Kugelgelenk, RH	30	K22	105	
0 267 743 1 361 650 1 656 428	5398.00.00	Vodjica mosta Torque rod Achsstrebe Izmenljivi delovi Parts list Stuckliste 5594.96.00	70	Ø21 >30< <130>	605 RØ50	
0 273 203 1 399 724	3142.20.00	Zglob,RH M22x1,5 * Ball joint, RH Kugelgelenk, RH	40	30	95	



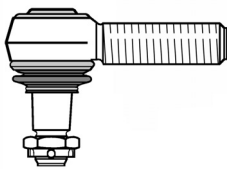
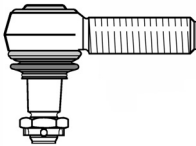
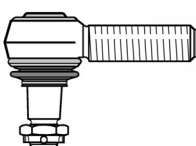
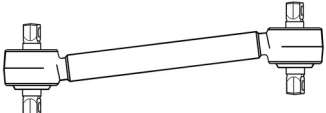
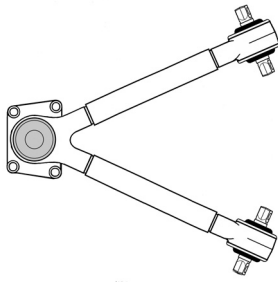
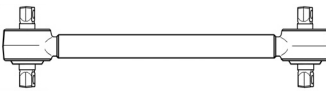

Originalni broj Cross-Ref.-No. Original Nr.	Br. FAD No. Nr.	Naziv Designation Bezeichnung	Kugla Ball Ø Größe	Konus Taper Konus	Duzina Length Länge	Skica Figure Bild
0 513 757 0 691 709	5594.96.00	Izmenljivi podsklop Repair kit Reparatur satz	70	Ø21 >30<	<130>	
0 516 089	3965.20.00	Zglob,RH M18x1,5 * Ball joint, RH Kugelgelenk, RH	30	K22	70	
0 586 714 0 696 226 0 607 073 0 609 634 0 609 643	5810.20.00	Zglob,RH M30x1,5 Ball joint, RH Kugelgelenk, RH	50	K30	135	
0 586 753 0 607 999 0 694 298 0 694 360 0 698 609 1 229 944 1 331 925	5741.20.00	Zglob,RH M30x1,5 Ball joint, RH Kugelgelenk, RH	35	K26	115	
0 589 943	6795.00.00	Spona upravljača Drag link Lenkstange Izmenljivi delovi Parts list Stuckliste 6795.20.00	35	K26	1058 RØ36	
0 607 053 0 696 225 1 228 115	5743.10.00	Zglob,LH M30x1,5 Ball joint, LH Kugelgelenk, LH	40	K30	120	
0 607 452	5746.10.00	Zglob,LH M28x1,5 Ball joint, LH Kugelgelenk, LH	30	K22	105	

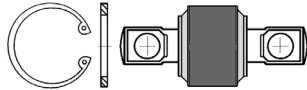
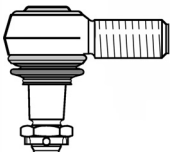
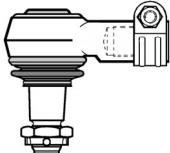
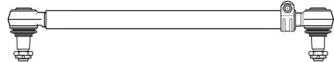
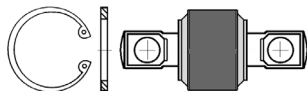
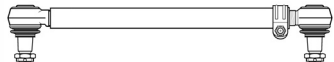

Originalni broj Cross-Ref.-No. Original Nr.	Br. FAD No. Nr.	Naziv Designation Bezeichnung	Kugla Ball Ø Größe	Konus Taper Konus	Duzina Length Länge	Skica Figure Bild
0 607 981 0 698 450 1 257 890 1 603 789	5743.20.00	Zglob,RH M30x1,5 Ball joint, RH Kugelgelenk, RH	40	K30	120	
0 607 998 1 319 838	5741.10.00	Zglob,LH M30x1,5 Ball joint, LH Kugelgelenk, LH	35	K26	115	
0 608 530	5805.20.00	Zglob,RH M24x1,5 Ball joint, RH Kugelgelenk, RH	30	K20	95	
0 646 373 0 655 695 0 655 697 1 284 860 1 620 438	5399.00.00	Vodjica mosta Torque rod Achsstrebe Izmenljivi delovi Parts list Stuckliste 5594.96.00	70	Ø21 >30< <130>	600 RØ50	
0 649 819 1 620 437 1 793 877	3876.00.00	V Vodjica mosta Triangular torque rod Dreieckslenker Izmenljivi delovi Parts list Stuckliste 5587.96.00 5943.90.00	80	Ø23 >35< <152>	604 RØ58	
0 658 104	6772.00.00	Vodjica mosta Torque rod Achsstrebe Izmenljivi delovi Parts list Stuckliste 5170.96.00	70	Ø19 >30< <130>	600 RØ50	

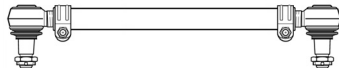
Originalni broj Cross-Ref.-No. Original Nr.	Br. FAD No. Nr.	Naziv Designation Bezeichnung	Kugla Ball Ø Größe	Konus Taper Konus	Duzina Length Länge	Skica Figure Bild
0 661 406 0 661 407	5386.00.00	Vodjica mosta Torque rod Achsstrebe Izmenljivi delovi Parts list Stuckliste 5386.96.00	78.5	Ø21 >35< <130>	600 RØ58	
0 689 747	5847.96.00	Izmenljivi podsklop Repair kit Reparatur satz	70	K45		
0 689 748	5323.96.00	Izmenljivi podsklop Repair kit Reparatur satz	62	Ø17 >24<	<115>	
0 689 749	5170.96.00	Izmenljivi podsklop Repair kit Reparatur satz	70	Ø19 >30<	<130>	
0 691 703	3744.96.00	Izmenljivi podsklop Repair kit Reparatur satz	70	Ø21 >24<	<152>	
0 691 704	5121.90.00	Izmenljivi podsklop Repair kit Reparatur satz	65	K38		
0 693 778	3755.90.00	Izmenljivi podsklop Repair kit Reparatur satz	65	Ø21 >24<	<152>	
0 696 600	3875.90.00	Izmenljivi podsklop Repair kit Reparatur satz	65	K38		

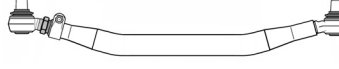
Originalni broj Cross-Ref.-No. Original Nr.	Br. FAD No. Nr.	Naziv Designation Bezeichnung	Kugla Ball Ø Größe	Konus Taper Konus	Duzina Length Länge	Skica Figure Bild
0 698 724	3873.96.00	Izmenljivi podsklop Repair kit Reparatur satz	70	Ø23 >24<	<152>	
0 817 823	6297.20.00	Zglob,RHM24x1,5 Ball joint, RH Kugelgelenk, RH	40	K30	75	
0 817 824	7474.20.00	Zglob,RHM24x1,5 * Ball joint, RH Kugelgelenk, RH	40	K30	95	
1 143 324 1 191 900	6781.00.00	Spona upravljača Drag link Lenkstange Izmenljivi delovi Parts list Stuckliste 5741.20.00	35	K26	1190 RØ40	
1 243 618	6409.96.00	Izmenljivi podsklop Repair kit Reparatur satz	55	Ø17 >24<	<115>	
1 257 991 1 351 718 1 385 493	6782.00.00	Spona upravljača Drag link Lenkstange Izmenljivi delovi Parts list Stuckliste 5741.20.00	35	K26	860 RØ36	

Originalni broj Cross-Ref.-No. Original Nr.	Br. FAD No. Nr.	Naziv Designation Bezeichnung	Kugla Ball Ø Größe	Konus Taper Konus	Duzina Length Länge	Skica Figure Bild
1 257 992 1 351 732 1 385 490	6773.00.00	Spona upravljača Drag link Lenkstange Izmenljivi delovi Parts list Stuckliste 5741.20.00 5741.10.00	35	K26	831 RØ36	
1 261 101	5387.00.00	Vodjica mosta Torque rod Achsstrebe Izmenljivi delovi Parts list Stuckliste 3755.90.00 5959.90.00	65	Ø19 Ø21 >30< >24<	390 RØ50	
1 271 124	5959.90.00	Izmenljivi podsklop Repair kit Reparatur satz	65	Ø19 >30<	<130>	
1 283 211 1 351 714 1 385 497	6784.00.00	Spona upravljača Drag link Lenkstange Izmenljivi delovi Parts list Stuckliste 5741.20.00	35	K26	876 RØ52	
1 283 212 1 351 715 1 385 492	5389.00.00	Spona upravljača Drag link Lenkstange Izmenljivi delovi Parts list Stuckliste 5741.20.00	35	K26	848 RØ52	

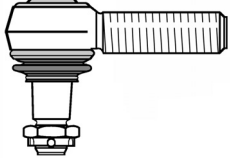
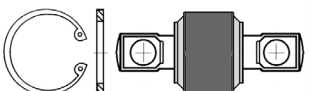
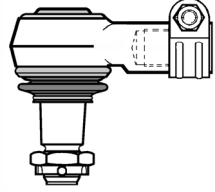
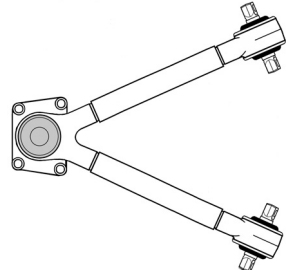
Originalni broj Cross-Ref.-No. Original Nr.	Br. FAD No. Nr.	Naziv Designation Bezeichnung	Kugla Ball Ø Größe	Konus Taper Konus	Duzina Length Länge	Skica Figure Bild
1 290 321 1 353 394	6780.00.00	Poprečna spona Tie rod Spurstange Izmenljivi delovi Parts list Stuckliste 5741.10.00 5741.20.00	35	K26	1752 RØ40	
1 291 048 1 351 735 1 385 500	6793.00.00	Spona upravljača Drag link Lenkstange Izmenljivi delovi Parts list Stuckliste 5741.20.00	35	K26	1008 RØ62	
1 291 060 1 351 734 1 385 499	3879.00.00	Spona upravljača Drag link Lenkstange Izmenljivi delovi Parts list Stuckliste 5741.20.00	35	K26	1005 RØ52	
1 297 572 1 361 155	6786.00.00	Poprečna spona Tie rod Spurstange Izmenljivi delovi Parts list Stuckliste 6791.20.00	35	K26	1522 RØ52	
1 306 333 1 351 741 1 385 487	6794.00.00	Spona upravljača Drag link Lenkstange Izmenljivi delovi Parts list Stuckliste 5741.20.00	35	K26	588 RØ40	
1 315 530 1 351 731 1 385 506	6783.00.00	Spona upravljača Drag link Lenkstange	35	K26	1658 RØ52	

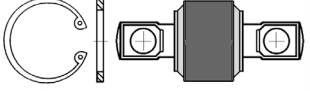
Originalni broj Cross-Ref.-No. Original Nr.	Br. FAD No. Nr.	Naziv Designation Bezeichnung	Kugla Ball Ø Größe	Konus Taper Konus	Duzina Length Länge	Skica Figure Bild
1 320 855 1 342 026	3903.20.00	Zglob,RH M30x1,5 Ball joint, RH Kugelgelenk, RH	35	K26	141	
1 321 936	5128.96.00	Izmenljivi podsklop Repair kit Reparatur satz	55	Ø19 >24<	<130>	
1 344 684	6795.20.00	Zglob,RHM24x1,5 * Ball joint, RH Kugelgelenk, RH	35	K26	115	
1 361 652 1 620 436 1 793 876	3877.00.00	V Vodjica mosta Triangular torque rod Dreieckslenker Izmenljivi delovi Parts list Stuckliste 5943.90.00 3873.96.00	80/70	Ø23 >24< <152> K46	608 RØ50	
1 363 858 1 448 062	6787.00.00	Spona upravljača Drag link Lenkstange Izmenljivi delovi Parts list Stuckliste 5743.20.00	40	K30	855 RØ52	
1 376 729	6771.96.00	Izmenljivi podsklop Repair kit Reparatur satz	62	Ø23 >24<	<152>	

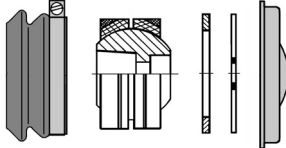
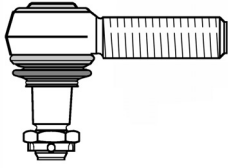
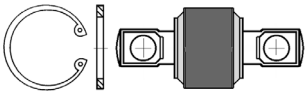
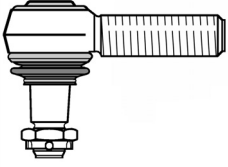
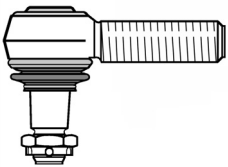
Originalni broj Cross-Ref.-No. Original Nr.	Br. FAD No. Nr.	Naziv Designation Bezeichnung	Kugla Ball Ø Größe	Konus Taper Konus	Duzina Length Länge	Skica Figure Bild
1 395 994	6796.00.00	Spona upravljača Drag link Lenkstange Izmenljivi delovi Parts list Stuckliste 5743.20.00	40	K30	991 RØ50	
1 398 368	6770.90.00	Izmenljivi podsklop Repair kit Reparatur satz	65	K38		
3 093 647	4233.20.00	Zglob,RH M30x1,5 Ball joint, RH Kugelgelenk, RH	40	K28,6	141	
696 321	5587.96.00	Izmenljivi podsklop Repair kit Reparatur satz	78.5	Ø23 >35<	<152>	
ACU 9239	6790.10.00	Zglob,LH M28x1,5 Ball joint, LH Kugelgelenk, LH	35	K22	180	
ACU 9240	6790.20.00	Zglob,RH M28x1,5 Ball joint, RH Kugelgelenk, RH	35	K22	180	

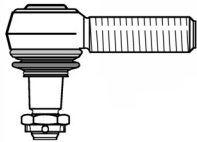
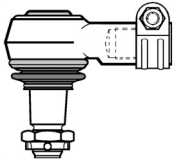
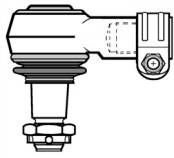
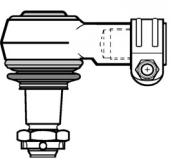
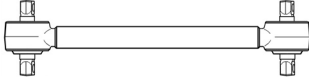
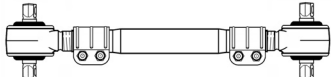
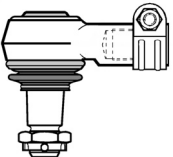
Originalni broj Cross-Ref.-No. Original Nr.	Br. FAD No. Nr.	Naziv Designation Bezeichnung	Kugla Ball Ø Größe	Konus Taper Konus	Duzina Length Länge	Skica Figure Bild
0598 660	5741.20.00	Zglob,RH M30x1,5 Ball joint, RH Kugelgelenk, RH	35	K26	115	
1124 113 8408 188	7474.20.00	Zglob,RH M24x1,5 * Ball joint, RH Kugelgelenk, RH	40	K30	95	
4125 657	5899.20.00	Zglob,RH M22x1,5 * Ball joint, RH Kugelgelenk, RH	35	K26	90	
9970 7007 727	4303.20.00	Zglob,RH M26x1,5 * Ball joint, RH Kugelgelenk, RH	50	K38	105	
9970 7016 595	4305.00.00	Vodjica mosta Torque rod Achsstrebe Izmenljivi delovi Parts list Stuckliste 5170.96.00	70	Ø19 >30< <130>	700 RØ50	
9970 7016 596	6100.00.00	Vodjica mosta Torque rod Achsstrebe Izmenljivi delovi Parts list Stuckliste 6027.10.00 6027.20.00	66	Ø19 >30< <130>	900 RØ60	
9970 7016 597	4304.20.00	Zglob,RH M30x1,5 * Ball joint, RH Kugelgelenk, RH	50	K38	105	

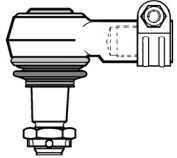
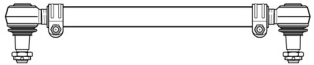
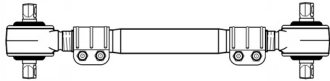
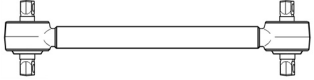
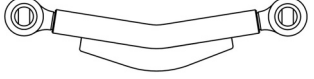
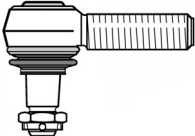

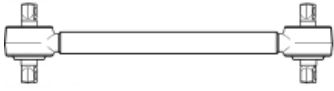
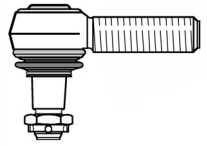
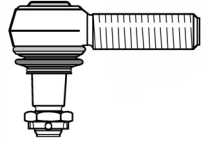

Originalni broj Cross-Ref.-No. Original Nr.	Br. FAD No. Nr.	Naziv Designation Bezeichnung	Kugla Ball Ø Größe	Konus Taper Konus	Duzina Length Länge	Skica Figure Bild
9970 7016 598	4311.20.00	Zglob,RH M30x1,5 * Ball joint, RH Kugelgelenk, RH	50	K38	105	
9970 7016 599	4310.00.00	Spona upravljacka Drag link Lenkstange Izmenljivi delovi Parts list Stuckliste 4310.10.00 4310.20.00	47	K38	1125 RØ56	
9970 7017 730	4315.00.00	Vodjica mosta Torque rod Achsstrebe Izmenljivi delovi Parts list Stuckliste 5170.96.00	70	Ø19 >30< <130>	700 RØ50	
9970 7060 050	4323.00.00	Vodjica mosta Torque rod Achsstrebe Izmenljivi delovi Parts list Stuckliste	53	Ø18.5 >24< <110>	655 RØ50	
9970 7060 051	4324.00.00	Vodjica mosta Torque rod Achsstrebe Izmenljivi delovi Parts list Stuckliste	53	Ø18.5 >24< <110>	655 RØ50	
9970 7731 304	4307.20.00	Zglob,RH M38x1,5 Ball joint, RH Kugelgelenk, RH	47	K38	135	

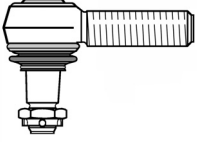
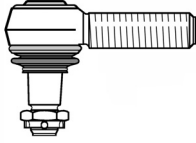
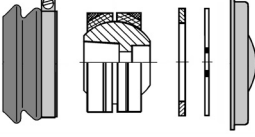
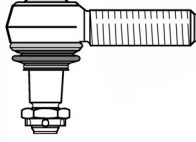
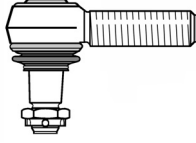
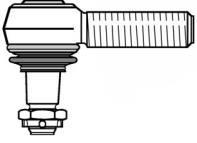
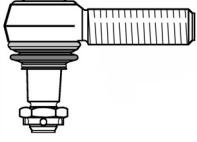

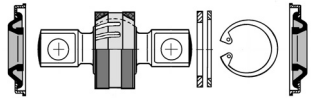
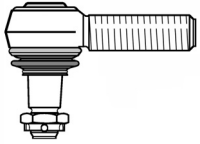
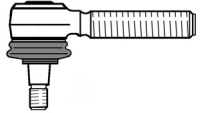
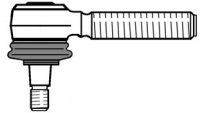
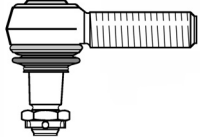
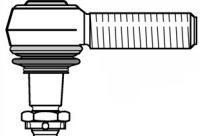
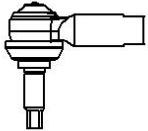
Originalni broj Cross-Ref.-No. Original Nr.	Br. FAD No. No. Nr.	Naziv Designation Bezeichnung	Kugla Ball Ø Größe	Konus Taper Konus	Duzina Length Länge	Skica Figure Bild
9970 7791 455	4314.00.00	Vodjica mosta Torque rod Achsstrebe Izmenljivi delovi Parts list Stuckliste 5170.96.00	70	Ø19 >30< <130>	700 RØ60	
9970 8408 376	3581.10.00	Zglob,LH M38x1,5 Ball joint, LH Kugelgelenk, LH	50	38	135	
9970 8408 377	3581.20.00	Zglob,RH M38x1,5 Ball joint, RH Kugelgelenk, RH	50	38	135	

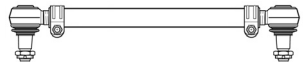



Originalni broj Cross-Ref.-No. Original Nr.	Br. FAD No. No. Nr.	Naziv Designation Bezeichnung	Kugla Ball Ø Größe	Konus Taper Konus	Duzina Length Länge	Skica Figure Bild
0813 7026 4100 2770 4100 9665 4102 8598 4102 8600 4103 4479 4104 2050	5120.00.00	V Vodjica mosta Triangular torque rod Dreieckslenker Izmenljivi delovi Parts list Stuckliste 5861.96.00 5120.90.00	65/62	Ø21 >24< <130> K38	665 RØ50	
0928 1792 928 1792	7474.20.00	Zglob,RH 24x1.5 * Ball joint, RH Kugelgelenk, RH	40	K30	95	
247 5843 4201 4656 4202 6837 4202 6840 4203 7655 4203 7657	6364.00.00	Poprecna spona Tie rod Spurstange Izmenljivi delovi Parts list Stuckliste 5743.10.00 5743.20.00	40	K30	1606 RØ50	
4203 2936	5094.00.00	Vodjica mosta Torque rod Achsstrebe Izmenljivi delovi Parts list Stuckliste 5170.96.00	70	Ø19 >30< <130>	635 RØ50	
4203 2938	5095.00.00	Vodjica mosta Torque rod Achsstrebe Izmenljivi delovi Parts list Stuckliste 5170.96.00	70	Ø19 >30< <130>	617 RØ50	

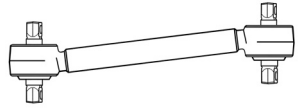
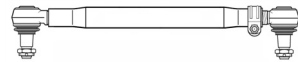
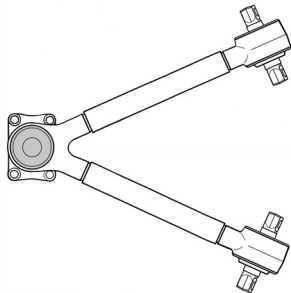

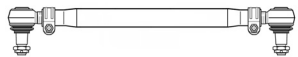
Originalni broj Cross-Ref.-No. Original Nr.	Br. FAD No. Nr.	Naziv Designation Bezeichnung	Kugla Ball Ø Größe	Konus Taper Konus	Duzina Length Länge	Skica Figure Bild
296 6252 296 9808 4248 3386 4248 8269 4248 9573 4248 9594 4249 1638 480 2443 483 3829 812 2752	5743.20.00	Zglob,RH M30x1.5 Ball joint, RH Kugelgelenk, RH	40	K30	120	
296 6321 296 6635 4248 4886 483 3825 819 3645 855 8533 858 2322	5746.20.00	Zglob,RH M28x1.5 Ball joint, RH Kugelgelenk, RH	30	K22	105	
296 8454	5121.90.00	Izmenljivi podsklop Repair kit Reparatur satz	65	K38		
296 9507 4248 4887 483 3826 812 3394 855 8536	5746.10.00	Zglob,LH M28x1.5 Ball joint, LH Kugelgelenk, LH	30	K22	105	
298 0129 298 4511 4249 3782 483 3821 483 3826 483 3828 812 2755	5741.10.00	Zglob,LH M30x1.5 Ball joint, LH Kugelgelenk, LH	35	K26	115	
298 0323 4248 3520 4249 3781	5741.20.00	Zglob,RH M30x1.5 Ball joint, RH Kugelgelenk, RH	35	K26	115	
298 0875	5742.20.00	Zglob,RH M30x1.5 Ball joint, RH Kugelgelenk, RH	40	K26	120	

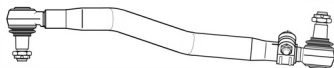
Originalni broj Cross-Ref.-No. Original Nr.	Br. FAD No. No. Nr.	Naziv Designation Bezeichnung	Kugla Ball Ø Größe	Konus Taper Konus	Duzina Length Länge	Skica Figure Bild
298 0884	5959.90.00	Izmenljivi podsklop Repair kit Reparatur satz	65	Ø19 >30<	<130>	
298 4061 4248 9395 4249 1957 480 2444 483 3830 819 0225	5743.10.00	Zglob,LH M30x1.5 Ball joint, LH Kugelgelenk, LH	40	K30	120	
343 5788 4204 2912	3567.20.00	Zglob,RH M16x1.5 Ball joint, RH Kugelgelenk, RH	22	K12	90	
343 5786 798 1909 8602 7074	3590.20.00	Zglob,RH M14x1.5 Ball joint, RH Kugelgelenk, RH	22	K12	85	
401 8036 466 3787	5391.20.00	Zglob,RH M25x1.5 Ball joint, RH Kugelgelenk, RH	30	K22	105	
401 8037 466 3791	5391.10.00	Zglob,LH M25x1.5 Ball joint, LH Kugelgelenk, LH	30	K22	105	
4100 2118 4120 3863 4204 1327 4207 9853	6432.20.00	Zglob,RH M10x1.5 Ball joint, RH Kugelgelenk, RH	10	K10	55	

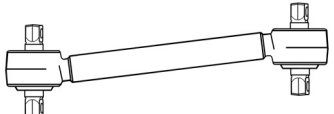
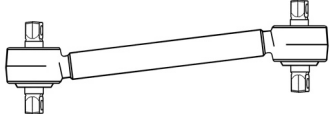
Originalni broj Cross-Ref.-No. Original Nr.	Br. FAD No. No. Nr.	Naziv Designation Bezeichnung	Kugla Ball Ø Größe	Konus Taper Konus	Duzina Length Länge	Skica Figure Bild
4100 5309 4100 5460 816 5309	6405.00.00	Poprecna spona Tie rod Spurstange Izmenljivi delovi Parts list Stuckliste 5743.10.00 5743.20.00	40	K30	1577 RØ42	
4100 5463 813 1582 813 2397	5119.00.00	Spona upravljacka Drag link Lenkstange Izmenljivi delovi Parts list Stuckliste 5743.20.00	40	K30	950 RØ52	
4100 5466 4101 6964	6398.00.00	Spona upravljacka Drag link Lenkstange Izmenljivi delovi Parts list Stuckliste 5743.20.00	40	K30	698 RØ52	
4100 5469 4101 1476 4101 6960 4101 6961 813 5492	6414.00.00	Spona upravljacka Drag link Lenkstange Izmenljivi delovi Parts list Stuckliste 5743.20.00	40	K30	824 RØ52	
4100 5475 4100 6093	6422.00.00	Spona upravljacka Drag link Lenkstange Izmenljivi delovi Parts list Stuckliste 5743.20.00	40	K30	952 RØ52	

Originalni broj Cross-Ref.-No. Original Nr.	Br. FAD No. No. Nr.	Naziv Designation Bezeichnung	Kugla Ball Ø Größe	Konus Taper Konus	Duzina Length Länge	Skica Figure Bild
4101 1006 4206 5332	5106.00.00	Vodjica mosta Torque rod Achsstrebe Izmenljivi delovi Parts list Stuckliste 5096.96.00	78.5	Ø21 >24< <152>	612 RØ58	
4102 8269 4129 8449	6430.00.00	Spona upravljača Drag link Lenkstange Izmenljivi delovi Parts list Stuckliste 5743.20.00	40	K30	887 RØ52	
4102 8599 4104 2092 9847 2468	3569.00.00	V Vodjica mosta Triangular torque rod Dreieckslenker Izmenljivi delovi Parts list Stuckliste 5117.96.00 5120.90.00	65/62	Ø21 >24< <130> K38	659 RØ50	
4103 2608 4103 3237	6424.00.00	Poprecna spona Tie rod Spurstange Izmenljivi delovi Parts list Stuckliste 5743.10.00 5743.20.00	40	K30	1477 RØ50	
4103 6943	6418.00.00	Poprecna spona Tie rod Spurstange Izmenljivi delovi Parts list Stuckliste 5743.10.00 5743.20.00	40	K30	1620 RØ50	

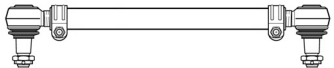
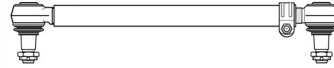

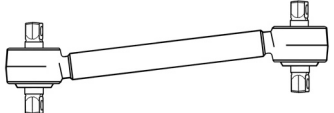
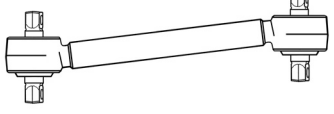

Originalni broj Cross-Ref.-No. Original Nr.	Br. FAD No. No. Nr.	Naziv Designation Bezeichnung	Kugla Ball Ø Größe	Konus Taper Konus	Duzina Length Länge	Skica Figure Bild
4121 5165	6423.00.00	Spona upravljača Drag link Lenkstange Izmenljivi delovi Parts list Stuckliste 5743.20.00	40	K30	959 RØ52	
4121 4657	6415.00.00	Spona upravljača Drag link Lenkstange Izmenljivi delovi Parts list Stuckliste 5743.20.00	40	K30	952 RØ52	
4200 0481 4203 4054	5104.00.00	Vodjica mosta Torque rod Achsstrebe Izmenljivi delovi Parts list Stuckliste 5096.96.00	78.5	Ø21 >35< <152>	610 RØ60	
4200 0486 4203 4051	5097.00.00	Vodjica mosta Torque rod Achsstrebe Izmenljivi delovi Parts list Stuckliste 5096.96.00	78.5	Ø21 >35< <152>	630 RØ60	
4200 1325 4200 1326 4208 6458	5118.00.00	Spona upravljača Drag link Lenkstange Izmenljivi delovi Parts list Stuckliste 5743.20.00	40	K30	880 RØ42	

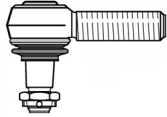
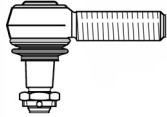
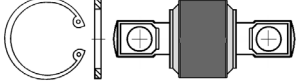
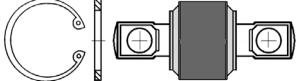
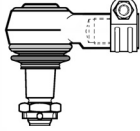
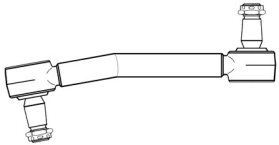

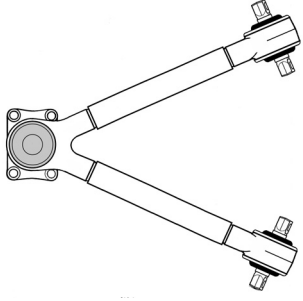
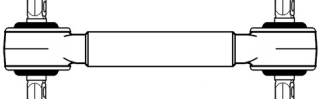
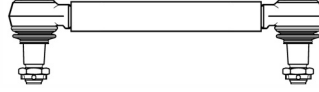

Originalni broj Cross-Ref.-No. Original Nr.	Br. FAD No. No. Nr.	Naziv Designation Bezeichnung	Kugla Ball Ø Größe	Konus Taper Konus	Duzina Length Länge	Skica Figure Bild
4200 3432	6403.00.00	Poprecna spona Tie rod Spurstange Izmenljivi delovi Parts list Stuckliste 5743.10.00 5743.20.00	40	K30	1640 RØ50	
4201 9062	5108.00.00	Spona upravljacka Drag link Lenkstange Izmenljivi delovi Parts list Stuckliste 5743.20.00	40	K30	894 RØ40	
4203 7386 8601 2923	6359.00.00	Poprecna spona Tie rod Spurstange Izmenljivi delovi Parts list Stuckliste 5746.10.00 5746.20.00	30	K22	1404 RØ36	
4204 1107	5105.00.00	Vodjica mosta Torque rod Achsstrebe Izmenljivi delovi Parts list Stuckliste 3744.96.00	70	Ø21 >24< <152>	610 RØ50	
4204 2431	5096.00.00	Vodjica mosta Torque rod Achsstrebe Izmenljivi delovi Parts list Stuckliste 5096.96.00	78.5	Ø21 >35< <152>	600 RØ60	

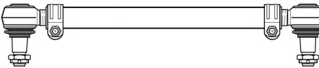

Originalni broj Cross-Ref.-No. Original Nr.	Br. FAD No. No. Nr.	Naziv Designation Bezeichnung	Kugla Ball Ø Größe	Konus Taper Konus	Duzina Length Länge	Skica Figure Bild
4204 2950 4204 3912	5144.00.00	Spona upravljača Drag link Lenkstange Izmenljivi delovi Parts list Stuckliste 5743.20.00	40	K30	905 RØ42	
4205 5474	5107.00.00	Spona upravljača Drag link Lenkstange Izmenljivi delovi Parts list Stuckliste 5743.20.00	40	K30	850 RØ40	
4208 7842 474 7960 474 7961	5113.00.00	Spona upravljača Drag link Lenkstange Izmenljivi delovi Parts list Stuckliste 5743.20.00	40	K30	980 RØ50	
4208 8124 472 0262	6397.00.00	Spona upravljača Drag link Lenkstange	40	K30	2421 RØ50	
4212 5057 471 4134 9848 8010	5081.00.00	Vodjica mosta Torque rod Achsstrebe Izmenljivi delovi Parts list Stuckliste 3698.90.00	65	Ø19 >30< <130>	580 RØ50	
4212 5057 471 4134 9848 8010	5114.00.00	Vodjica mosta Torque rod Achsstrebe Izmenljivi delovi Parts list Stuckliste 5959.90.00	65	Ø19 >30< <130>	580 RØ50	

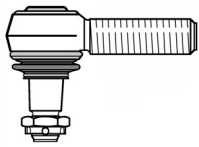
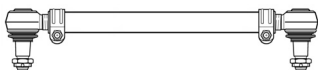
Originalni broj Cross-Ref.-No. Original Nr.	Br. FAD No. No. Nr.	Naziv Designation Bezeichnung	Kugla Ball Ø Größe	Konus Taper Konus	Duzina Length Länge	Skica Figure Bild
4220 0700 4220 4475 4221 1146 4221 1148	3537.00.00	Spona upravljača Drag link Lenkstange Izmenljivi delovi Parts list Stuckliste 5746.20.00	30	K22	865 RØ36	
4248 0023 4253 2543 819 3649	5805.10.00	Zglob,LH M24x1.5 Ball joint, LH Kugelgelenk, LH	30	K20	95	
4248 0024 4249 1937	5805.20.00	Zglob,RH M24x1.5 Ball joint, RH Kugelgelenk, RH	30	K20	95	
4248 8722	5170.96.00	Izmenljivi podsklop Repair kit Reparatur satz	70	Ø19 >30<	<130>	
4249 3431 9319 2619	3765.96.00	Izmenljivi podsklop Repair kit Reparatur satz	78.5	Ø21 >24<	<152>	
4253 3101 4253 3102	6425.20.00	Zglob,RH M26x1.5 * Ball joint, RH Kugelgelenk, RH	40	K30	80	
445 7748 9319 1941	3559.00.00	Vodjica mosta Torque rod Achsstrebe Izmenljivi delovi Parts list Stuckliste 3559.96.00	70	K38	695 RØ50	

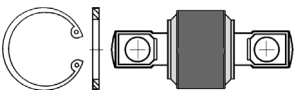
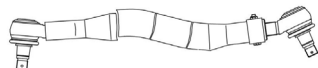
Originalni broj Cross-Ref.-No. Original Nr.	Br. FAD No. No. Nr.	Naziv Designation Bezeichnung	Kugla Ball Ø Größe	Konus Taper Konus	Duzina Length Länge	Skica Figure Bild
445 7748 9319 1941	5111.00.00	Vodjica mosta Torque rod Achsstrebe Izmenljivi delovi Parts list Stuckliste 5109.90.00	65	K38	695 RØ50	
466 3787	3203.20.00	Zglob,RH M25x1.5 Ball joint, RH Kugelgelenk, RH	30	K22	105	
468 8941 716 7757 856 5366 858 2332	5122.20.00	Zglob,RH M28x1.5 Ball joint, RH Kugelgelenk, RH	35	K26	115	
468 8948	5856.20.00	Zglob,RH M38x1.5 Ball joint, RH Kugelgelenk, RH	40	K30	120	
468 8949	5856.10.00	Zglob,LH M38x1.5 Ball joint, LH Kugelgelenk, LH	40	K30	120	
471 1108 471 1109	5143.00.00	Spona upravljača Drag link Lenkstange Izmenljivi delovi Parts list Stuckliste 5856.20.00	40	K30	850 RØ50	
471 6271	5121.00.00	V Vodjica mosta Triangulartorque rod Dreieckslenker Izmenljivi delovi Parts list Stuckliste 5959.90.00 5121.90.00	65/65	Ø19 >30< <130> K38	657/ 688 RØ50	

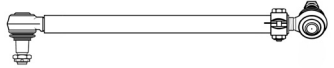
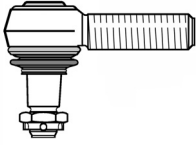
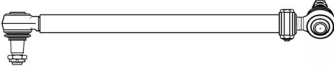
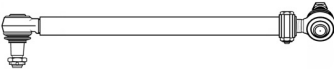

Originalni broj Cross-Ref.-No. Original Nr.	Br. FAD No. No. Nr.	Naziv Designation Bezeichnung	Kugla Ball Ø Größe	Konus Taper Konus	Duzina Length Länge	Skica Figure Bild
471 6799	5126.00.00	V Vodjica mosta Triangulartorque rod Dreieckslenker Izmenljivi delovi Parts list Stuckliste 5959.90.00 5121.90.00	65/65	Ø19 >30< <130> K38	657/ 688 RØ50	
471 9609	5116.00.00	Vodjica mosta Torque rod Achsstrebe Izmenljivi delovi Parts list Stuckliste 5959.90.00	65	Ø19 >30< <130>	677 RØ50	
474 1171	6339.00.00	Stabilizator Stabilizer link Koppelstang	40	K30	355 RØ40	
477 3359 483 4037	5122.00.00	Spona upravljača Drag link Lenkstange Izmenljivi delovi Parts list Stuckliste 5122.20.00	35	K26	975 RØ36	
485 4871	6404.00.00	Poprecna spona Tie rod Spurstange Izmenljivi delovi Parts list Stuckliste 5741.10.00 5741.20.00	35	K26	1584 RØ40	
485 4874	5123.00.00	Spona upravljača Drag link Lenkstange Izmenljivi delovi Parts list Stuckliste 5741.20.00	35	K26	900 RØ42	



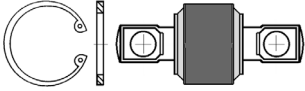
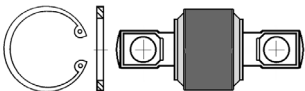
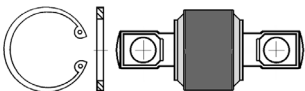
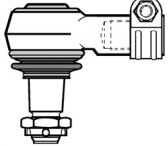
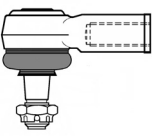
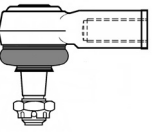
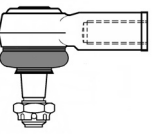

Originalni broj Cross-Ref.-No. Original Nr.	Br. FAD No. No. Nr.	Naziv Designation Bezeichnung	Kugla Ball Ø Größe	Konus Taper Konus	Duzina Length Länge	Skica Figure Bild
486 8942 858 2333	5122.10.00	Zglob, LH M28x1.5 Ball joint, LH Kugelgelenk, LH	35	K26	115	
500 307 556 9840 2553	6402.00.00	Poprecna spona Tie rod Spurstange Izmenljivi delovi Parts list Stuckliste 5741.10.00 5741.20.00	35	K26	1490 RØ40	
500 324 282	6429.00.00	Spona upravljacka Drag link Lenkstange Izmenljivi delovi Parts list Stuckliste 5741.20.00	35	K26	785 RØ40	
500 333 284	4569.96.00	Izmenljivi podsklop Repair kit Reparatur satz	62	Ø19 >24<	<130>	
5003 360 85	6433.00.00	Spona upravljacka Drag link Lenkstange Izmenljivi delovi Parts list Stuckliste 4681.20.00	40	K30	883 RØ52	
5003 977 38	4671.00.00	Spona upravljacka Drag link Lenkstange Izmenljivi delovi Parts list Stuckliste 5743.20.00	40	K30	959 RØ52	

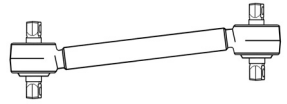
Originalni broj Cross-Ref.-No. Original Nr.	Br. FAD No. Nr.	Naziv Designation Bezeichnung	Kugla Ball Ø Größe	Konus Taper Konus	Duzina Length Länge	Skica Figure Bild
855 8522	5142.00.00	Spona upravljača Drag link Lenkstange Izmenljivi delovi Parts list Stuckliste 4746.20.00	30	K22	820 RØ30	
855 8527 4248 7165 9319 4626	4746.20.00	Zglob,RH M24x1.5 Ball joint, RH Kugelgelenk, RH	30	K22	105	
855 9559 859 1222	3212.00.00	Spona upravljača Drag link Lenkstange Izmenljivi delovi Parts list Stuckliste 4746.20.00	30	K22	830 RØ30	
856 4248 859 1219	5147.00.00	Spona upravljača Drag link Lenkstange Izmenljivi delovi Parts list Stuckliste 4746.20.00	30	K22	761 RØ30	
856 4386 858 2320	3213.00.00	Poprečna spona Tie rod Spurstange Izmenljivi delovi Parts list Stuckliste 5746.10.00 5746.20.00	30	K22	1348 RØ36	
856 5366 858 2330	3393.00.00	Poprečna spona Tie rod Spurstange Izmenljivi delovi Parts list Stuckliste 5122.10.00 5122.20.00	35	K26	1344 RØ36	

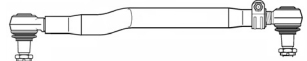
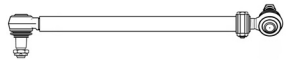
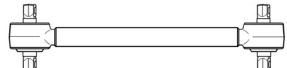
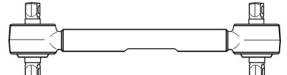
Originalni broj Cross-Ref.-No. Original Nr.	Br. FAD No. No. Nr.	Naziv Designation Bezeichnung	Kugla Ball Ø Größe	Konus Taper Konus	Duzina Length Länge	Skica Figure Bild
856 7618 858 2350	5145.00.00	Spona upravljacka Drag link Lenkstange Izmenljivi delovi Parts list Stuckliste 5122.20.00	35	K26	755 RØ40	
857 0528	5148.00.00	Spona upravljacka Drag link Lenkstange Izmenljivi delovi Parts list Stuckliste 5741.20.00	35	K26	690 RØ40	
858 7018	5087.00.00	Poprecna spona Tie rod Spurstange Izmenljivi delovi Parts list Stuckliste 5122.10.00 5122.20.00	35	K26	1316 RØ36	
8601 1651	6363.00.00	Poprecna spona Tie rod Spurstange Izmenljivi delovi Parts list Stuckliste 5741.10.00 5741.20.00	35	K26	1506 RØ40	
9316 1631 9316 1638	5120.90.00	Izmenljivi podsklop Repair kit Reparatur satz	65	K38		

Originalni broj Cross-Ref.-No. Original Nr.	Br. FAD No. Nr.	Naziv Designation Bezeichnung	Kugla Ball Ø Größe	Konus Taper Konus	Duzina Length Länge	Skica Figure Bild
9316 3617	5128.96.00	Izmenljivi podsklop Repair kit Reparatur satz	55	Ø19 >24<	<130>	
9319 2361	5117.96.00	Izmenljivi podsklop Repair kit Reparatur satz	62	Ø19 >24<	<130>	
9319 2618	3744.96.00	Izmenljivi podsklop Repair kit Reparatur satz	70	Ø21 >24<	<152>	
9319 2809	6426.20.00	Zglob,RH M30x1.5 * Ball joint, RH Kugelgelenk, RH	40	K30	80	
9380 0662 9380 4059	1480.20.00	Zglob,RH M16x1.5 * Ball joint, RH Kugelgelenk, RH	25	K18	80	
9380 0662 9380 4059	3228.20.00	Zglob,RH M16x1.5 * Ball joint, RH Kugelgelenk, RH	25	K18	80	
9380 2209 9380 4060	1481.20.00	Zglob,RH M20x1.5 * Ball joint, RH Kugelgelenk, RH	35	K24	72	

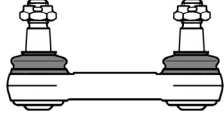
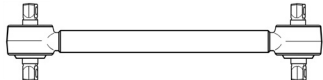

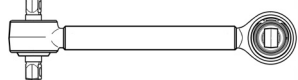
Originalni broj Cross-Ref.-No. Original Nr.	Br. FAD No. Nr.	Naziv Designation Bezeichnung	Kugla Ball Ø Größe	Konus Taper Konus	Duzina Length Länge	Skica Figure Bild
9710 4299	6341.00.00	Vodjica mosta Torque rod Achsstrebe Izmenljivi delovi Parts list Stuckliste 5117.96.00	62	Ø19 >24< <130>	803 RØ46	
9840 2544 9846 7459	5124.00.00	Spona upravljacka Drag link Lenkstange Izmenljivi delovi Parts list Stuckliste 5741.20.00	35	K26	820 RØ40	
9844 6354	5146.00.00	Spona upravljacka Drag link Lenkstange Izmenljivi delovi Parts list Stuckliste 5743.20.00	40	K30	895 RØ52	
9844 9025 9846 9650	6417.00.00	Spona upravljacka Drag link Lenkstange Izmenljivi delovi Parts list Stuckliste 5743.20.00	40	K30	878 RØ40	
9847 2466	6342.00.00	Vodjica mosta Torque rod Achsstrebe Izmenljivi delovi Parts list Stuckliste 5117.96.00	62	Ø19 >24< <130>	594 RØ46	
9847 2871	5117.00.00	Vodjica mosta Torque rod Achsstrebe Izmenljivi delovi Parts list Stuckliste 5117.96.00	62	Ø19 >24< <130>	595 RØ50	

Originalni broj Cross-Ref.-No. Original Nr.	Br. FAD No. Nr.	Naziv Designation Bezeichnung	Kugla Ball Ø Größe	Konus Taper Konus	Duzina Length Länge	Skica Figure Bild
9847 3328	6420.00.00	Spona upravljava Drag link Lenkstange Izmenljivi delovi Parts list Stuckliste 5743.20.00	40	K30	966 RØ50	
9847 5709	6427.00.00	Spona upravljava Drag link Lenkstange Izmenljivi delovi Parts list Stuckliste 5741.20.00	35	K26	1210 RØ52	
9848 4091	6395.00.00	Stabilizator Stabilizer link Koppelstang	35	K26	100 RØ32	
9848 8010	5103.00.00	Vodjica mosta Torque rod Achsstrebe Izmenljivi delovi Parts list Stuckliste 5170.96.00	70	Ø19 >30< <130>	583 RØ50	
9849 3054	6428.00.00	Spona upravljava Drag link Lenkstange Izmenljivi delovi Parts list Stuckliste 5743.20.00	40	K30	887 RØ40	
9944 4744	6344.00.00	Vodjica mosta Torque rod Achsstrebe Izmenljivi delovi Parts list Stuckliste 5117.96.00	62	Ø19 >24< <130>	644 RØ50	

KÄSSBOHRER

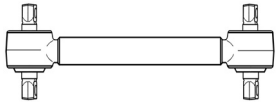
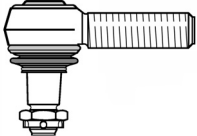
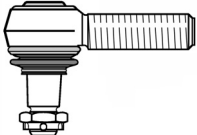
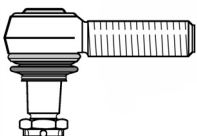
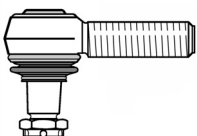
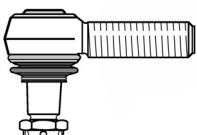

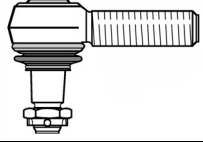
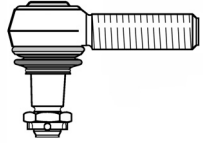
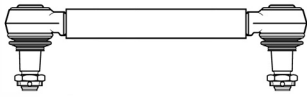
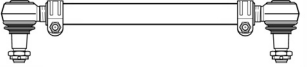

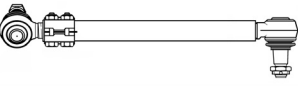

Originalni broj Cross-Ref.-No. Original Nr.	Br. FAD No. Nr.	Naziv Designation Bezeichnung	Kugla Ball Ø Größe	Konus Taper Konus	Duzina Length Länge	Skica Figure Bild
6.293.500.606 8.226.293.000B	6197.00.00	Vodjica mosta Torque rod Achsstrebe Izmenljivi delovi Parts list Stuck liste 5170.96.00	70	Ø19 >30< <130>	658 RØ50	
6.851.446.000 6.851.459.000 6.851.479.000 6.851.487.000 6.851.532.000	5742.10.00	Zglob,LH M30x1,5 Ball joint, LH Kugelgelenk, LH	40	K26	120	
6.851.447.000 6.851.478.000 6.851.486.000 6.851.488.000 6.851.523.000	5742.20.00	Zglob,RH M30x1,5 Ball joint, RH Kugelgelenk, RH	40	K26	120	
6.851.475.000 6.851.480.000 6.851.484.000 6.851.531.000 8.226.236.059	5743.20.00	Zglob,RH M30x1,5 Ball joint, RH Kugelgelenk, RH	40	K30	120	
6.851.485.000 8.226.236.058	5743.10.00	Zglob,LH M30x1,5 Ball joint, LH Kugelgelenk, LH	40	K30	120	
6.851.490.000	3581.10.00	Zglob,LH M38x1,5 Ball joint, LH Kugelgelenk, LH	50	K38	135	

Originalni broj Cross-Ref.-No. Original Nr.	Br. FAD No. Nr.	Naziv Designation Bezeichnung	Kugla Ball Ø Größe	Konus Taper Konus	Duzina Length Länge	Skica Figure Bild
6.851.491.000	3581.20.00	Zglob,RH M38x1,5 Ball joint, RH Kugelgelenk, RH	50	K38	135	
6.851.517.000	5741.20.00	Zglob,RH M30x1,5 Ball joint, RH Kugelgelenk, RH	35	K26	115	
8.226.137.000 8.226.147.000C 8.226.305.000C 8.226.313.000C	3493.00.00	Spona upravljača Drag link Lenkstange Izmenljivi delovi Parts list Stuckliste 5742.20.00	40	K26	380 RØ40	
8.226.138.000 8.226.148.000C	5687.00.00	Spona upravljača Drag link Lenkstange Izmenljivi delovi Parts list Stuckliste 5742.20.00 5742.10.00	40	K26	655 RØ50	
8.226.232.000 8.226.241.000 8.226.357.000	3491.00.00	Vodjica mosta Torque rod Achsstrebe Izmenljivi delovi Parts list Stuck liste 5170.96.00	70	Ø19 >30< <130>	660 RØ50	
8.226.257.000	6042.00.00	Spona upravljača Drag link Lenkstange Izmenljivi delovi Parts list Stuckliste 3581.20.00	50	K38	910 RØ50	

KÄSSBOHRER

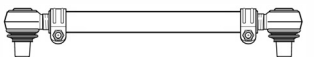
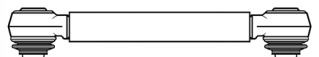

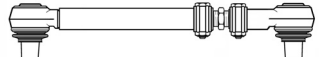
Originalni broj Cross-Ref.-No. Original Nr.	Br. FAD No. No. Nr.	Naziv Designation Bezeichnung	Kugla Ball Ø Größe	Konus Taper Konus	Duzina Length Länge	Skica Figure Bild
8.226.259.000 8.226.262.000 8.226.259.000C 8.226.262.000C	3494.00.00	Spona upravljača Drag link Lenkstange Izmenljivi delovi Parts list Stuckliste 5743.20.00 5743.10.00	40	K30	2165 RØ50	
8.226.294.000	6044.00.00	Poprecna spona Tie rod Spurstange Izmenljivi delovi Parts list Stuckliste 7476.20.00	40	K26	1765 RØ50	
8.226.306.000 8.226.244.000D 8.226.258.000C	3492.00.00	Poprecna spona Tie rod Spurstange Izmenljivi delovi Parts list Stuckliste 5742.20.00 5742.10.00	40	K26	670 RØ40	
8.226.307.000 8.226.347.000 8.226.247.000C	6049.00.00	Poprecna spona Tie rod Spurstange	40	K30	484 RØ40	
8.226.308.000 8.226.308.000C 8.226.248.000C 8.226.381.000	4911.00.00	Poprecna spona Tie rod Spurstange Izmenljivi delovi Part list Stuckliste 4911.20.00	40	K30	630 RØ40	
8.226.328.000	4912.00.00	Poprecna spona Tie rod Spurstange Izmenljivi delovi Part list Stuckliste 4911.20.00	40	K30	680 RØ40	

KÄSSBOHRER

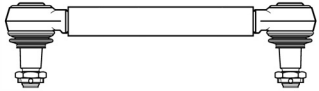
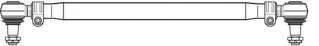
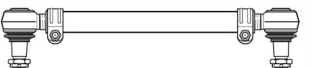
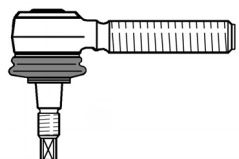
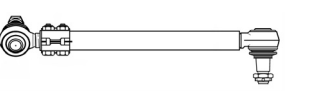
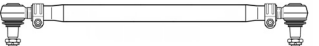

Originalni broj Cross-Ref.-No. Original Nr.	Br. FAD No. No. Nr.	Naziv Designation Bezeichnung	Kugla Ball Ø Größe	Konus Taper Konus	Duzina Length Länge	Skica Figure Bild
8.226.330.000	4915.00.00	Poprečna spona Tie rod Spurstange	40	K30	380 RØ40	
8.226.356.000	4913.00.00	Poprečna spona Tie rod Spurstange Izmenljivi delovi Parts list Stuckliste 5743.20.00 5743.10.00	40	K30	2130 RØ50	
8.226.380.000 8.226.380.000C	4914.00.00	Spona upravljača Drag link Lenkstange Izmenljivi delovi Parts list Stuckliste 5855.20.00 5743.10.00	40	K32 K30	870 RØ40	
8.321.999.319	3590.20.00	Zglob, RH M14x1.5 Ball joint, RH Kugelgelenk, RH	22	K12	85	
8.226.225.000D	6045.00.00	Poprečna spona Tie rod Spurstange Izmenljivi delovi Part list Stuckliste 3581.20.00	50	K38	647 RØ50	
8.226.238.000C	6048.00.00	Spona upravljača Drag link Lenkstange Izmenljivi delovi Part list Stuckliste 5743.20.00 5743.10.00	40	K30	1660 RØ50	

KÄSSBOHRER



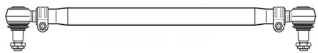
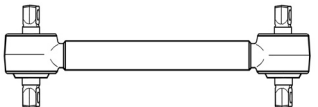
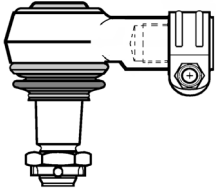
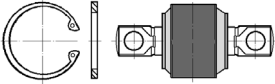
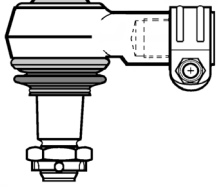

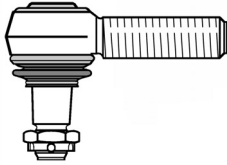
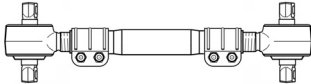
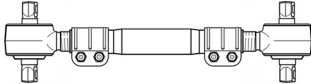
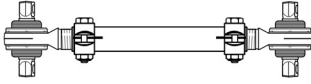
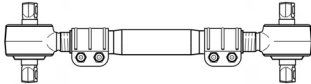
Originalni broj Cross-Ref.-No. Original Nr.	Br. FAD No. No.	Naziv Designation Bezeichnung	Kugla Ball Ø Größe	Konus Taper Konus	Duzina Length Länge	Skica Figure Bild
8.226.261.000C	6043.00.00	Spona upravljacka Drag link Lenkstange Izmenljivi delovi Parts list Stuckliste 5743.20.00 5743.10.00	40	K30	1585 RØ50	
8.226.318.000B 8.226.323.000B	3497.00.00	Vodjica mosta Torque rod Achsstrebe Izmenljivi delovi Parts list Stuckliste 5170.96.00	70	Ø19 >30< <130>	660 RØ50	
6.851.529.000	4911.20.00	Zglob,RHM30x1.5 * Ball joint,RH Kugelgelenk,RH	40	K30	120	
8.226.232.066.0	5170.96.00	Izmenljivi podsklop Repair kit Reparatur satz	70	Ø19 >30<	<130>	
8.851.360.000	7476.20.00	Zglob,RHM30x1.5 * Ball joint,RH Kugelgelenk,RH	40	K26	120	

Originalni broj Cross-Ref.-No. Original Nr.	Br. FAD No. No.	Naziv Designation Bezeichnung	Kugla Ball Ø Größe	Konus Taper Konus	Duzina Length Länge	Skica Figure Bild
1022 0897	3903.20.00	Zglob,RH M30x1,5 Ball joint, RH Kugelgelenk, RH	35	K26	141	
5211 434 08	6105.00.00	Vodjica mosta Torque rod Achsstrebe Izmenljivi delovi Parts list Stuckliste 6027.10.00 6027.20.00	66	Ø19 >30< <130>	620 RØ60	
5211 435 08	6027.00.00	Vodjica mosta Torque rod Achsstrebe Izmenljivi delovi Parts list Stuckliste 6027.10.00 6027.20.00	66	Ø19 >30< <130>	710 RØ60	
5211 438 5211 438 08	6106.00.00	Vodjica mosta Torque rod Achsstrebe Izmenljivi delovi Parts list Stuckliste 6106.10.00 6106.20.00	53	Ø17 >24< <115>	635 RØ50	
5211 439 08	6100.00.00	Vodjica mosta Torque rod Achsstrebe Izmenljivi delovi Parts list Stuckliste 6027.10.00 6027.20.00	66	Ø19 >30< <130>	900 RØ60	

Originalni broj Cross-Ref.-No. Original Nr.	Br. FAD No. Nr.	Naziv Designation Bezeichnung	Kugla Ball Ø Größe	Konus Taper Konus	Duzina Length Länge	Skica Figure Bild
5211 440 08	6101.00.00	Vodjica mosta Torque rod Achsstrebe Izmenljivi delovi Parts list Stuckliste 6027.10.00 6027.20.00	66	Ø19 >30< <130>	550 RØ60	
5211 441 5211 441 08	6102.00.00	Vodjica mosta Torque rod Achsstrebe Izmenljivi delovi Parts list Stuckliste 6027.10.00 6027.20.00	66	Ø19 >30< <130>	780 RØ60	
5211 448 5211 448 08	6103.00.00	Vodjica mosta Torque rod Achsstrebe Izmenljivi delovi Parts list Stuckliste 6027.10.00 6027.20.00	66	Ø19 >30< <130>	750 RØ60	
5211 543 08 5211 543	4484.96.00	Izmenljivi podsklop Repair kit Reparatur satz	83	Ø25 >24<	<152>	
5708 158 08	6106.20.00	Zglob,RH M38x1,5 Ball joint, RH Kugelgelenk, RH	53	Ø17 >24<	150 <115>	
5708 159 08	6106.10.00	Zglob,LH M38x1,5 Ball joint, LH Kugelgelenk, LH	53	Ø17 >24<	150 <115>	
5708 160 08	6027.20.00	Zglob,RH M48x1,5 Ball joint, RH Kugelgelenk, RH	66	Ø19 >30<	200 <130>	

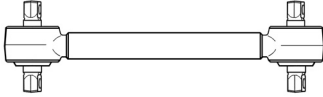
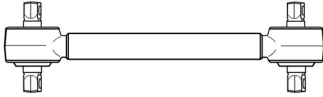

Originalni broj Cross-Ref.-No. Original Nr.	Br. FAD No. Nr.	Naziv Designation Bezeichnung	Kugla Ball Ø Größe	Konus Taper Konus	Duzina Length Länge	Skica Figure Bild
5708 161 08	6027.10.00	Zglob,LH M48x1,5 Ball joint, LH Kugelgelenk, LH	66	Ø19 >30<	200 <130>	
5708 196 08	6104.20.00	Zglob,RH M48x1,5 Ball joint, RH Kugelgelenk, RH	66	Ø21 >30<	200 <152>	
5708 197 08	6104.10.00	Zglob,LH M48x1,5 Ball joint, LH Kugelgelenk, LH	66	Ø21 >30<	200 <152>	
5718 665 08	5743.10.00	Zglob,LH M30x1,5 Ball joint, LH Kugelgelenk, LH	40	K30	120	
5718 666 08	5743.20.00	Zglob,RH M30x1,5 Ball joint, RH Kugelgelenk, RH	40	K30	120	
7250 510 08	7474.20.00	Zglob,RH M24x1,5 * Ball joint, RH Kugelgelenk, RH	40	K30	95	

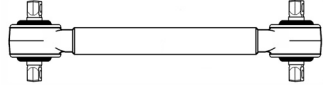
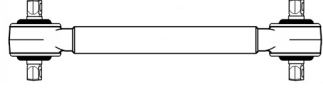
Originalni broj Cross-Ref.-No. Original Nr.	Br. FAD No. Nr.	Naziv Designation Bezeichnung	Kugla Ball Ø Größe	Konus Taper Konus	Duzina Length Länge	Skica Figure Bild
81 43220 6010 81 43220 6012 81 43220 6013 81 43220 6018 81 43220 6020 81 43220 6028 81 43220 6035 81 43220 6040 81 43220 6041 81 43220 6052 81 43220 6056	5910.00.00	Vodjica mosta Torque rod Achsstrebe Izmenljivi delovi Parts list Stuckliste 5170.96.00	70	Ø19 >30< <130>	565 RØ50	
81 43220 6025	5948.00.00	Vodjica mosta Torque rod Achsstrebe Izmenljivi delovi Parts list Stuckliste 5170.96.00	70	Ø19 >30< <130>	455 RØ50	
81 43220 6042	5951.00.00	Vodjica mosta Torque rod Achsstrebe Izmenljivi delovi Parts list Stuckliste 5170.96.00	70	Ø19 >30< <130>	762 RØ50	
81 43220 6043	5952.00.00	Vodjica mosta Torque rod Achsstrebe Izmenljivi delovi Parts list Stuckliste 5170.96.00	70	Ø19 >30< <130>	661 RØ50	
81 43220 6053	5531.96.00	Izmenljivi podsklop Repair kit Reparatur satz	78.5	Ø19 >40<	<130>	
81 43220 6055 81 43220 6073	5170.96.00	Izmenljivi podsklop Repair kit Reparatur satz	70	Ø19 >30<	<130>	

Originalni broj Cross-Ref.-No. Original Nr.	Br. FAD No. Nr.	Naziv Designation Bezeichnung	Kugla Ball Ø Größe	Konus Taper Konus	Duzina Length Länge	Skica Figure Bild
81 43220 6067 81 43220 6068 81 43220 6090 81 43220 6092 81 43220 9092	5950.00.00	Vodjica mosta Torque rod Achsstrebe Izmenljivi delovi Parts list Stuckliste 5170.96.00	70	Ø19 >30< <130>	590 RØ50	
81 43220 6070 81 43220 6071 81 43220 6072 81 43220 6091 81 43220 6093	5938.00.00	Vodjica mosta Torque rod Achsstrebe Izmenljivi delovi Parts list Stuckliste 5938.96.00	78.5	Ø19 >35< <130>	585 RØ58	
81 43220 6096 81 43220 6097 81 43220 6098 81 43220 6129 81 43230 6014 81 43230 6030	5546.00.00	Vodjica mosta Torque rod Achsstrebe Izmenljivi delovi Parts list Stuckliste 5546.90.00	62	Ø19 >30< <130>	571 RØ50	
81 43220 6096 81 43220 6097 81 43220 6098 81 43220 6129 81 43230 6014 81 43230 6030	5921.00.00	Vodjica mosta Torque rod Achsstrebe Izmenljivi delovi Parts list Stuckliste 3698.90.00	65	Ø19 >30< <130>	571 RØ50	
81 43220 6096 81 43220 6097 81 43220 6098 81 43220 6129 81 43230 6014 81 43230 6030	5937.00.00	Vodjica mosta Torque rod Achsstrebe Izmenljivi delovi Parts list Stuckliste 5170.96.00	70	Ø19 >30< <130>	570 RØ50	

Originalni broj Cross-Ref.-No. Original Nr.	Br. FAD No. No.	Naziv Designation Bezeichnung	Kugla Ball Ø Größe	Konus Taper Konus	Duzina Length Länge	Skica Figure Bild
81 43220 6096 81 43220 6097 81 43220 6098 81 43220 6129 81 43230 6014 81 43230 6030	5941.00.00	Vodjica mosta Torque rod Achsstrebe Izmenljivi delovi Parts list Stuckliste 3698.90.00	65	Ø19 >30< <130>	570 RØ50	
81 43220 6096 81 43220 6097 81 43220 6098 81 43220 6129 81 43230 6014 81 43230 6030	5959.00.00	Vodjica mosta Torque rod Achsstrebe Izmenljivi delovi Parts list Stuckliste 5959.90.00	65	Ø19 >30< <130>	571 RØ50	
81 43220 6099 81 43220 6100	5956.00.00	Vodjica mosta Torque rod Achsstrebe Izmenljivi delovi Parts list Stuckliste 5170.96.00	70	Ø19 >30< <130>	750 RØ50	
81 43220 6102 81 43220 6148 81 43220 6152 81 43220 6186	5538.00.00	Vodjica mosta Torque rod Achsstrebe Izmenljivi delovi Parts list Stuckliste 5170.96.00	70	Ø19 >30< <130>	670 RØ50	
81 43220 6106 81 43230 6049	6173.00.00	Vodjica mosta Torque rod Achsstrebe Izmenljivi delovi Parts list Stuckliste 5323.96.00	62	Ø17 >24< <115>	777 RØ60	
81 43220 6108	5959.90.00	Izmenljivi podsklop Repair kit Reparatur satz	65	Ø19 >30<	<130>	

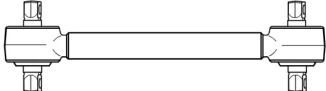
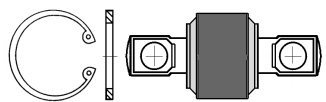
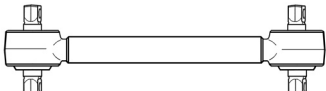
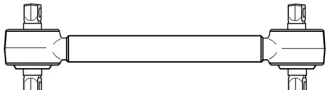
Originalni broj Cross-Ref.-No. Original Nr.	Br. FAD No. Nr.	Naziv Designation Bezeichnung	Kugla Ball Ø Größe	Konus Taper Konus	Duzina Length Länge	Skica Figure Bild
81 43220 6129	6181.00.00	Vodjica mosta Torque rod Achsstrebe Izmenljivi delovi Parts list Stuckliste 5323.96.00	62	Ø19 >24< <130>	577 RØ50	
81 43220 6140 81 43220 9140	6186.00.00	Vodjica mosta Torque rod Achsstrebe Izmenljivi delovi Parts list Stuckliste 5959.90.00 6186.90.00	65/40	Ø19/ Ø18.5 >30</ >24< <130>/ <102>	596 RØ50	
81 43220 6161 81 43220 6190	4108.00.00	Vodjica mosta Torque rod Achsstrebe Izmenljivi delovi Parts list Stuckliste 5170.96.00	70	Ø19 >30< <130>	531 RØ50	
81 43220 6168	5339.00.00	Vodjica mosta Torque rod Achsstrebe Izmenljivi delovi Parts list Stuckliste 3935.96.00	55	Ø17 >20< <100>	570 RØ40	
81 43220 6174	6191.00.00	Vodjica mosta Torque rod Achsstrebe Izmenljivi delovi Parts list Stuckliste 5959.90.00 6186.90.00	65/40	Ø19/ Ø18.5 >30</ >24< <130>/ <102>	644 RØ50	

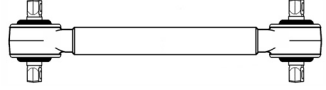
Originalni broj Cross-Ref.-No. Original Nr.	Br. FAD No. No. Nr.	Naziv Designation Bezeichnung	Kugla Ball Ø Größe	Konus Taper Konus	Duzina Length Länge	Skica Figure Bild
81 43220 6189	4107.00.00	Vodjica mosta Torque rod Achsstrebe Izmenljivi delovi Parts list Stuckliste 5170.96.00	70	Ø19 >30< <130>	614 RØ50	
81 43220 6203	5594.90.00	Izmenljivi podsklop Repair kit Reparatur satz	70	Ø21 >30<	<130>	
81 43220 6236 81 43220 6267 81 43220 6272	6188.00.00	Vodjica mosta Torque rod Achsstrebe Izmenljivi delovi Parts list Stuckliste 5959.90.00	65	Ø19 >30< <130>	566 RØ50	
81 43220 6247	6201.00.00	Vodjica mosta Torque rod Achsstrebe Izmenljivi delovi Parts list Stuckliste 6201.90.00	65	Ø23 >30< <130>	414 RØ50	
81 43230 6015 81 43230 6031 81 43230 9031	5940.00.00	Vodjica mosta Torque rod Achsstrebe Izmenljivi delovi Parts list Stuckliste 3698.90.00	65	Ø19 >30< <130>	595 RØ50	
81 43230 6037	3698.00.00	Vodjica mosta Torque rod Achsstrebe Izmenljivi delovi Parts list Stuckliste 3698.90.00	65	Ø19 >30< <130>	500 RØ50	



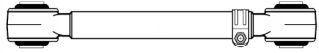
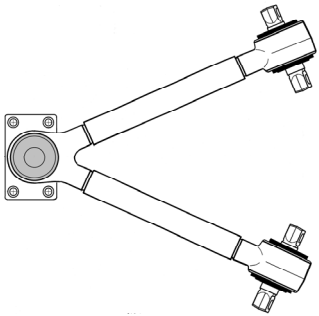
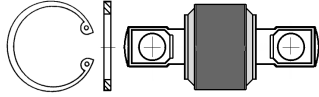
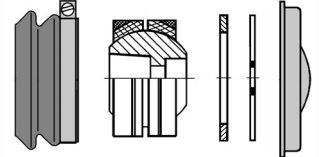
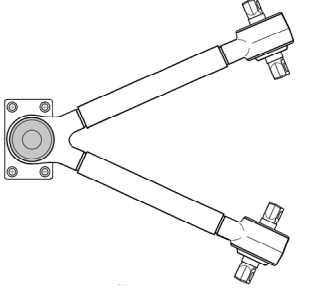
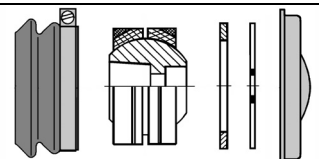

Originalni broj Cross-Ref.-No. Original Nr.	Br. FAD No. Nr.	Naziv Designation Bezeichnung	Kugla Ball Ø Größe	Konus Taper Konus	Duzina Length Länge	Skica Figure Bild
81 43230 6037	5537.00.00	Vodjica mosta Torque rod Achsstrebe Izmenljivi delovi Parts list Stuckliste 3698.90.00	70	Ø19 >30< <130>	500 RØ50	
81 43230 6038 81 43230 6039	5922.00.00	Vodjica mosta Torque rod Achsstrebe Izmenljivi delovi Parts list Stuckliste 3698.90.00	65	Ø19 >30< <130>	750 RØ50	
81 43230 6043	3698.90.00	Izmenljivi podsklop Repair kit Reparatur satz	65	Ø19 >30<	<130>	
81 43230 6051 81 43230 6068 81 43270 6064	5323.90.00	Izmenljivi podsklop Repair kit Reparatur satz	62	Ø17 >24<	<115>	
81 43230 6061	5117.96.00	Izmenljivi podsklop Repair kit Reparatur satz	62	Ø19 >24<	<130>	
81 43250 6007	5554.00.00	Vodjica mosta Torque rod Achsstrebe Izmenljivi delovi Parts list Stuckliste 5554.20.00	40	Ø20	840 RØ40	
81 43250 6014	4130.00.00	Vodjica mosta Torque rod Achsstrebe Izmenljivi delovi Parts list Stuckliste 5554.20.00	40	Ø20	840 RØ40	



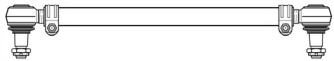
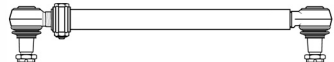

Originalni broj Cross-Ref.-No. Original Nr.	Br. FAD No. No. Nr.	Naziv Designation Bezeichnung	Kugla Ball Ø Größe	Konus Taper Konus	Duzina Length Länge	Skica Figure Bild
81 43250 6016	4137.00.00	Vodjica mosta Torque rod Achsstrebe Izmenljivi delovi Parts list Stuckliste 5554.20.00	40	Ø20	880 RØ40	
81 43270 6030 81 43270 6034 81 43270 6057 81 43270 6074 81 43270 6076 81 43270 6078 81 43270 6082 81 43270 9034 81 43270 9078	5943.00.00	V Vodjica mosta Triangular torque rod Dreieckslenker Izmenljivi delovi Parts list Stuckliste 5943.90.00 5945.90.00	65/80	Ø23 >35< <152> K46	621 RØ58	
81 43270 6040 81 43270 6045	3765.96.00	Izmenljivi podsklop Repair kit Reparatur satz	78.5	Ø21 >24<	<152>	
81 43270 6047	3500.90.00	Izmenljivi podsklop Repair kit Reparatur satz	80	K40		
81 43270 6056 81 43270 6067 81 43270 6075 81 43270 6077 81 43270 6081 81 43270 9056	5944.00.00	V Vodjica mosta Triangular torque rod Dreieckslenker Izmenljivi delovi Parts list Stuckliste 5943.90.00 5944.96.00	78.5	Ø23 >24< <152> K46	627 RØ58	
81 43270 6065	5524.90.00	Izmenljivi podsklop Repair kit Reparatur satz	65	K38		

Originalni broj Cross-Ref.-No. Original Nr.	Br. FAD No. Nr.	Naziv Designation Bezeichnung	Kugla Ball Ø Größe	Konus Taper Konus	Duzina Length Länge	Skica Figure Bild
81 43270 6079	5587.96.00	Izmenljivi podsklop Repair kit Reparatur satz	78.5	Ø23 >35<	<150>	
81 43270 6096	6189.00.00	V Vodjica mosta Triangular torque rod Dreieckslenker Izmenljivi delovi Parts list Stuckliste 4103.96.00	80/70	Ø23 >24< <130> K46	627 RØ50	
81 43270 6105	4492.96.00	Izmenljivi podsklop Repair kit Reparatur satz	70	Ø25 >24<	<130>	
81 43270 6079	5944.96.00	Izmenljivi podsklop Repair kit Reparatur satz	80	Ø23 >24<	<152>	
81 43270 6117	6219.00.00	V Vodjica mosta Torque rod Achsstrebe Izmenljivi delovi Parts list Stuckliste 4492.90.00 5943.90.00	70/ 80	Ø25 >24< <130> K46	627 RØ58	
81 43315 6012	5535.00.00	Vodjica mosta Torque rod Achsstrebe Izmenljivi delovi Parts list Stuckliste 5535.10.00 5535.20.00	78.5	Ø34	652 RØ50	
81 43718 6006 81 43718 6007	5522.00.00	Vodjica mosta Torque rod Achsstrebe Izmenljivi delovi Parts list Stuckliste 5522.96.00	45	Ø15 >20< <90>	464 RØ40	

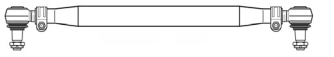

Originalni broj Cross-Ref.-No. Original Nr.	Br. FAD No. Nr.	Naziv Designation Bezeichnung	Kugla Ball Ø Größe	Konus Taper Konus	Duzina Length Länge	Skica Figure Bild
81 43718 6009	5522.96.00	Izmenljivi podsklop Repair kit Reparatur satz	45	Ø15 >20<	<90>	
81 46610 6088 81 46610 6288	5520.00.00	Spona upravljača Drag link Lenkstange Izmenljivi delovi Parts list Stuckliste 5743.20.00	40	K30/ K26	800 RØ40	
81 46610 6089 81 46610 6291	5539.00.00	Spona upravljača Drag link Lenkstange Izmenljivi delovi Parts list Stuckliste 5742.20.00	40	K26	815 RØ42	
81 46610 6129	5335.00.00	Spona upravljača Drag link Lenkstange Izmenljivi delovi Parts list Stuckliste 5743.20.00	40	K30	810 RØ40	
81 46610 6147 81 46610 6194 81 46610 6195 81 46610 6201 81 46610 6257 81 46610 6415 81 46610 6476 81 46610 6503 81 46610 6532 81 46610 6608 81 46610 6630	5946.00.00	Spona upravljača Drag link Lenkstange Izmenljivi delovi Parts list Stuckliste 5743.10.00 5743.20.00	40	K30	1853 RØ52	
81 46610 6159 81 46610 6200 81 46610 6275 81 46610 6317 81 46611 6064 81 46610 6319	5219.00.00	Spona upravljača Drag link Lenkstange Izmenljivi delovi Parts list Stuckliste 5743.10.00 5743.20.00	40	K30	710 RØ40	

Originalni broj Cross-Ref.-No. Original Nr.	Br. FAD No. Nr.	Naziv Designation Bezeichnung	Kugla Ball Ø Größe	Konus Taper Konus	Duzina Length Länge	Skica Figure Bild
81 46610 6196 81 46610 6202 81 46610 6258 81 46610 6409 81 46610 6504 81 46610 6531 81 46610 6593 81 46610 6609 81 46610 6631 81 46610 6740	5932.00.00	Spona upravljava Drag link Lenkstange Izmenljivi delovi Parts list Stuckliste 5743.10.00 5743.20.00	40	K30	1953 RØ52	
81.46610.6281 81.46610.6300 81.46610.6303 81.46610.6304 81.46610.6327 81.46610.6329	4152.00.00	Spona upravljava Drag link Lenkstange Izmenljivi delovi Parts list Stuckliste 5805.20.00	30	K20	785 RØ30	
81 46610 6292 81 46610 6424 81 46610 6432 81 46610 6434 81 46610 6437 81 46610 6513 81 46610 6537 81 46610 6596 81 46610 6614 81 46610 6635 81 46610 6735 81 46610 6743	5235.00.00	Spona upravljava Drag link Lenkstange Izmenljivi delovi Parts list Stuckliste 5743.10.00 5743.20.00	40	K30	1922 RØ50	
81 46610 6301 81 46610 6305 81 46610 6328	5534.00.00	Spona upravljava Drag link Lenkstange Izmenljivi delovi Parts list Stuckliste 5746.20.00	30	K22	785 RØ40	
81 46610 6333 81 46610 6334 81 46610 6354 81 46610 6355 81 46610 6360 81 46610 6361 81 46610 6721 81 46610 6722 81 46610 6723	5536.00.00	Spona upravljava Drag link Lenkstange Izmenljivi delovi Parts list Stuckliste 5743.20.00	40	K30	1030 RØ50	

Originalni broj Cross-Ref.-No. Original Nr.	Br. FAD No. Nr.	Naziv Designation Bezeichnung	Kugla Ball Ø Größe	Konus Taper Konus	Duzina Length Länge	Skica Figure Bild
81 46610 6348	4118.00.00	Poprecna spona Tie rod Spurstange Izmenljivi delovi Parts list Stuckliste 5743.10.00 5743.20.00	40	K30	770 RØ42	
81 46610 6374 81 46611 6019	5975.00.00	Spona upravljacka Drag link Lenkstange Izmenljivi delovi Parts list Stuckliste 5743.10.00 5743.20.00	40	K30	1050 RØ42	
81 46610 6376	6206.00.00	Spona upravljacka Drag link Lenkstange Izmenljivi delovi Parts list Stuckliste 5743.20.00	40	K30	1400 RØ40	
81 46610 6414	5532.00.00	Spona upravljacka Drag link Lenkstange Izmenljivi delovi Parts list Stuckliste 5741.20.00	35	K26	930 RØ40	
81.46610.6578 81.46610.6798 81.46610.6876	4145.00.00	Spona upravljacka Drag link Lenkstange Izmenljivi delovi Parts list Stuckliste 5743.10.00 5743.20.00	40	K30	755 RØ40	
81 46610 6643	6221.00.00	Spona upravljacka Drag link Lenkstange Izmenljivi delovi Parts list Stuckliste 5743.20.00	40	K30	1140 RØ50	

Originalni broj Cross-Ref.-No. Original Nr.	Br. FAD No. Nr.	Naziv Designation Bezeichnung	Kugla Ball Ø Größe	Konus Taper Konus	Duzina Length Länge	Skica Figure Bild
81 46610 6656 81 46610 6659	5259.00.00	Spona upravljača Drag link Lenkstange Izmenljivi delovi Parts list Stuckliste 5743.20.00	40	K30	1070 RØ50	
81 46610 6689 81 46610 6720	6203.00.00	Poprečna spona Tie rod Spurstange Izmenljivi delovi Parts list Stuckliste 5743.10.00 5743.20.00	40	K30	1406 RØ50	
81 46610 6708 81 46611 6067	6198.00.00	Spona upravljača Drag link Lenkstange Izmenljivi delovi Parts list Stuckliste 5743.20.00	40	K30	905 RØ52	
81 46610 6716 81 46611 6068	6202.00.00	Spona upravljača Drag link Lenkstange Izmenljivi delovi Parts list Stuckliste 5743.20.00	40	K30	745 RØ50	
81 46610 6725 85 46610 6030 85 46610 6102 85 46610 6201	4115.00.00	Spona upravljača Drag link Lenkstange Izmenljivi delovi Parts list Stuckliste 7414.20.00	30	K20	825 RØ32	
81 46610 6753 81 46610 6754 85 46610 6104	4116.00.00	Spona upravljača Drag link Lenkstange Izmenljivi delovi Parts list Stuckliste 5746.20.00	30	K22	815 RØ40	

Originalni broj Cross-Ref.-No. Original Nr.	Br. FAD No. No. Nr.	Naziv Designation Bezeichnung	Kugla Ball Ø Größe	Konus Taper Konus	Duzina Length Länge	Skica Figure Bild
81 46610 6756	6211.00.00	Spona upravljača Drag link Lenkstange	40	K30	921 RØ60	
81 46610 6767 81 46610 6768 81 46611 6014	7685.00.00	Spona upravljača Drag link Lenkstange Izmenljivi delovi Parts list Stuckliste 5743.10.00 5743.20.00	40	K30	900 RØ40	
81 46610 6779 81 46610 6780 81 46610 6782	6212.00.00	Spona upravljača Drag link Lenkstange Izmenljivi delovi Parts list Stuckliste 5536.20.00	40	K30	1060 RØ50	
81 46610 6790 81 46610 6791 82 46610 6191	4136.00.00	Spona upravljača Drag link Lenkstange	40	K30	1749 RØ52	
81 46611 6004 81 46611 6005	6224.00.00	Poprecna spona Tie rod Spurstange Izmenljivi delovi Parts list Stuckliste 5743.20.00	40	K30	1063 RØ42	
81 46611 6096	6196.00.00	Spona upravljača Drag link Lenkstange Izmenljivi delovi Parts list Stuckliste 5743.20.00	40	K30	960 RØ52	

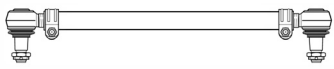
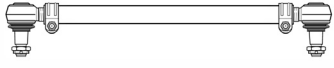



Originalni broj Cross-Ref.-No. Original Nr.	Br. FAD No. No. Nr.	Naziv Designation Bezeichnung	Kugla Ball Ø Größe	Konus Taper Konus	Duzina Length Länge	Skica Figure Bild
81 46611 6133	6223.00.00	Spona upravljacka Drag link Lenkstange Izmenljivi delovi Parts list Stuckliste 4126.20.00	40	K30	993 RØ52	
81 46611 6197 81 46611 6198	6216.00.00	Spona upravljacka Drag link Lenkstange Izmenljivi delovi Parts list Stuckliste 4126.20.00	40	K30	993 RØ52	
81 46611 6199 81 46611 6200	4131.00.00	Spona upravljacka Drag link Lenkstange Izmenljivi delovi Parts list Stuckliste 4126.20.00	40	K30	967 RØ52	
81.46710.6037 81.46710.6054 81.46710.6059 81 46710 6145 81.46710.6302	6179.00.00	Spona upravljacka Drag link Lenkstange Izmenljivi delovi Parts list Stuckliste 5743.10.00 5743.20.00	40	K30	1690 RØ40	
81 46710 6080 81 46710 6136 81 46710 6172 81 46710 6295 81 46710 6337 81 46710 6345 81 46710 6421 81 46710 6451 81 46710 6876	5933.00.00	Poprecna spona Tie rod Spurstange Izmenljivi delovi Parts list Stuckliste 5743.10.00 5743.20.00	40	K30	501 RØ40	

Originalni broj Cross-Ref.-No. Original Nr.	Br. FAD No. Nr.	Naziv Designation Bezeichnung	Kugla Ball Ø Größe	Konus Taper Konus	Duzina Length Länge	Skica Figure Bild
81 46710 6081 81 46710 6137 81 46710 6173 81 46710 6294 81 46710 6419 81 46710 6444 81 46710 6759 81 46710 6760 81 46710 6761 81 46710 6877 81 46710 6879	5934.00.00	Poprecna spona Tie rod Spurstange	40	K30	729 RØ40	
81 46710 6112 81 46710 6163 81 46710 6165 81 46710 6198 81 46710 6353 81 46710 6354 81 46710 6361 81 46711 6725	5216.00.00	Poprecna spona Tie rod Spurstange Izmenljivi delovi Parts list Stuckliste 5743.10.00 5743.20.00	40	K30	1652 RØ50	
81 46710 6117 81 46710 6281 81 46710 6282 81 46710 6370 81 46710 6371 81 46710 6372	4104.00.00	Poprecna spona Tie rod Spurstange Izmenljivi delovi Parts list Stuckliste 5741.10.00 5741.20.00	35	K26	1605 RØ36	
81 46710 6131 81 46710 6265 81 46710 6266 81 46710 6359 81 46710 6360 81 46710 6362 81 46710 6396 81 46710 6397 81 46710 6816 81 46710 6904 81 46711 6724	5564.00.00	Poprecna spona Tie rod Spurstange Izmenljivi delovi Parts list Stuckliste 5743.20.00	40	K30	1628 RØ50	
81 46710 6167 81 46710 6194 81 46710 6195 81 46710 6378 81 46710 6379 81 46710 6380 81 46710 6830 81 46710 6836 81 46710 6912 81 46711 6736	4134.00.00	Poprecna spona Tie rod Spurstange Izmenljivi delovi Parts list Stuckliste 5743.20.00	40	K30	1588 RØ52	

Originalni broj Cross-Ref.-No. Original Nr.	Br. FAD No. No. Nr.	Naziv Designation Bezeichnung	Kugla Ball Ø Größe	Konus Taper Konus	Duzina Length Länge	Skica Figure Bild
81 46710 6175 81 46710 6242 81 46710 6251 81 46710 6420	3777.00.00	Poprecna spona Tie rod Spurstange	40	K30	786 RØ40	
81 46710 6176 81 46710 6340 81 46710 6344 81 46710 6422	3776.00.00	Poprecna spona Tie rod Spurstange Izmenljivi delovi Parts list Stuckliste 5743.10.00 5743.20.00	40	K30	399 RØ40	
81 46710 6236 81 46710 6267 81 46710 6268 81 46710 6355 81 46710 6356 81 46710 6373 81 46711 6723	5210.00.00	Poprecna spona Tie rod Spurstange Izmenljivi delovi Parts list Stuckliste 5743.10.00 5743.20.00	40	K30	1692 RØ50	
81 46710 6238 81 46710 6240 81 46710 6409 81 46710 6410	5245.00.00	Poprecna spona Tie rod Spurstange Izmenljivi delovi Parts list Stuckliste 5746.10.00 5746.20.00	30	K22	1430 RØ36	
81 46710 6388 81 46710 6393	5215.00.00	Poprecna spona Tie rod Spurstange Izmenljivi delovi Parts list Stuckliste 5741.10.00 5741.20.00	35	K26	1585 RØ46	

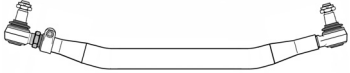
Originalni broj Cross-Ref.-No. Original Nr.	Br. FAD No. No. Nr.	Naziv Designation Bezeichnung	Kugla Ball Ø Größe	Konus Taper Konus	Duzina Length Länge	Skica Figure Bild
81 46710 6418	6222.00.00	Poprecna spona Tie rod Spurstange Izmenljivi delovi Parts list Stuckliste 5743.20.00	40	K30	1795 RØ50	
81 46710 6434 81 46710 6435 81 46710 6456	5333.00.00	Spona upravljaca Drag link Lenkstange Izmenljivi delovi Parts list Stuckliste 5741.20.00	35	K26	904 RØ50	
81 46710 6436	6213.00.00	Spona upravljaca Drag link Lenkstange Izmenljivi delovi Parts list Stuckliste 5741.20.00	35	K26	895 RØ40	
81 46710 6438 81 46710 6439	6214.00.00	Spona upravljaca Drag link Lenkstange Izmenljivi delovi Parts list Stuckliste 5741.20.00	35	K26	1000 RØ40	
81 46710 6443	6207.00.00	Poprecna spona Tie rod Spurstange Izmenljivi delovi Parts list Stuckliste 5743.20.00	40	K30	1005 RØ42	
81 46710 6453 81 46710 6457 81 46710 6458 81 46710 6875 81 46710 6881 81 46711 6765 81 46711 6766 81 46711 6767	4123.00.00	Poprecna spona Tie rod Spurstange	40	K30	699 RØ40	



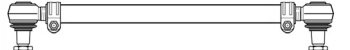

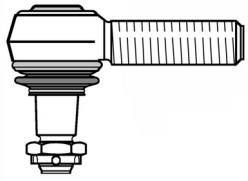
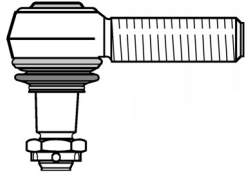
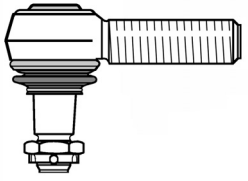
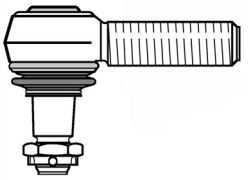
Originalni broj Cross-Ref.-No. Original Nr.	Br. FAD No. Nr.	Naziv Designation Bezeichnung	Kugla Ball Ø Größe	Konus Taper Konus	Duzina Length Länge	Skica Figure Bild
81 46710 6459 81 46710 6818 81 46710 6908	5976.00.00	Poprečna spona Tie rod Spurstange Izmenljivi delovi Parts list Stuckliste 5741.20.00	35	K26	1725 RØ50	
81 46710 6459	5977.00.00	Poprečna spona Tie rod Spurstange Izmenljivi delovi Parts list Stuckliste 5741.20.00	35	K26	1717 RØ50	
81 46710 6851 81 46710 6852 81 46711 6719 81 46711 6729	4119.00.00	Poprečna spona Tie rod Spurstange Izmenljivi delovi Parts list Stuckliste 5746.10.00 5746.20.00	30	K22	1620 RØ36	
81 46710 6862 81 46710 6863 81 46710 6864 81 46710 6909 81 46710 6910 81 46710 6974 81 46711 6786	6792.00.00	Poprečna spona Tie rod Spurstange Izmenljivi delovi Parts list Stuckliste 6791.20.00	35	K26	1698 RØ50	
81 46710 6865 81 46710 6866 81 46711 6728	5332.00.00	Poprečna spona Tie rod Spurstange Izmenljivi delovi Parts list Stuckliste 5805.10.00 5805.20.00	30	K20	1645 RØ30	
81 46710 6918 81 46711 6740 82 46710 6031	4094.00.00	Poprečna spona Tie rod Spurstange Izmenljivi delovi Parts list Stuckliste 5743.20.00	40	K30	1585 RØ60	

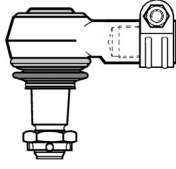
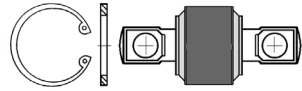
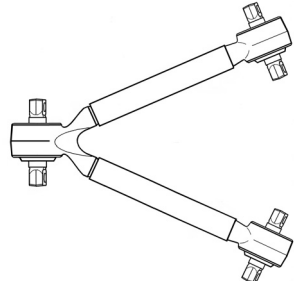

Originalni broj Cross-Ref.-No. Original Nr.	Br. FAD No. Nr.	Naziv Designation Bezeichnung	Kugla Ball Ø Größe	Konus Taper Konus	Duzina Length Länge	Skica Figure Bild
81 46710 6966 81 46711 6714	4133.00.00	Poprečna spona Tie rod Spurstange Izmenljivi delovi Parts list Stuckliste 4133.20.00	40	K30	1625 RØ50	
81 46710 6994 81 46711 6726	6215.00.00	Poprečna spona Tie rod Spurstange Izmenljivi delovi Parts list Stuckliste 5743.20.00	40	K30	1664 RØ50	
81 46711 6711	4132.00.00	Poprečna spona Tie rod Spurstange Izmenljivi delovi Parts list Stuckliste 6791.20.00	35	K26	1650 RØ50	
81 46711 6715 81 46711 6823	6791.00.00	Poprečna spona Tie rod Spurstange Izmenljivi delovi Parts list Stuckliste 6791.20.00	35	K26	1700 RØ52	
81.46711.6773 81 46711 6858	6218.00.00	Poprečna spona Tie rod Spurstange Izmenljivi delovi Parts list Stuckliste 6832.20.00	40	K30	1680 RØ50	
81.46711.6802 81.46711.6804 81.46711.6808 81.46711.6891 81.46711.6892 81.46711.6895	4148.00.00	Poprečna spona Tie rod Spurstange Izmenljivi delovi Parts list Stuckliste 5746.10.00 5746.20.00	30	K22	1666 RØ36	

Originalni broj Cross-Ref.-No. Original Nr.	Br. FAD No. Nr.	Naziv Designation Bezeichnung	Kugla Ball Ø Größe	Konus Taper Konus	Duzina Length Länge	Skica Figure Bild
81 95301 0013 81 95301 0074 81 95301 6163 81 95301 6068 90 80415 3113 90 80415 3107	5741.10.00	Zglob,LH M30x1.5 Ball joint, LH Kugelgelenk, LH	35	K26	115	
81 95301 0014 81 95301 0064 81 95301 6239 81 95301 6067 81 95301 6162 90 80415 3111	5741.20.00	Zglob,RH M30x1.5 Ball joint, RH Kugelgelenk, RH	35	K26	115	
81 95301 0015 81 95301 0083 81 95301 0087 81 95301 6030 81 95301 6043 81 95301 6050 81 95301 6054 81 95301 6087 81 95301 6091 81 95301 6155 81 95301 6168 81 95301 6179 81 95301 6237 81 95301 6279	5743.10.00	Zglob,LH M30x1.5 Ball joint, LH Kugelgelenk, LH	40	K30	120	
81 95301 0016 81 95301 0084 81 95301 6048 81 95301 6049 81 95301 6053 81 95301 6090 81 95301 6108 81 95301 6112 81 95301 6126 81 95301 6143 81 95301 6149 81 95301 6154 81 95301 6156 81 95301 6178 81 95301 6194 81 95301 6224 81 95301 6234 81 95301 6274	5743.20.00	Zglob,RH M30x1.5 Ball joint, RH Kugelgelenk, RH	40	K30	120	

Originalni broj Cross-Ref.-No. Original Nr.	Br. FAD No. Nr.	Naziv Designation Bezeichnung	Kugla Ball Ø Größe	Konus Taper Konus	Duzina Length Länge	Skica Figure Bild
81 95301 0022	5810.20.00	Zglob,RH M30x1.5 Ball joint, RH Kugelgelenk, RH	50	K30	135	
81 95301 0025 90 80415 4117	5742.20.00	Zglob,RH M30x1.5 Ball joint, RH Kugelgelenk, RH	40	K26	120	
81 95301 0038 81 95301 0045 81 95301 6016 81 95301 6169 81 95301 6172 81 95301 6176	3590.20.00	Zglob,RH M14x1.5 Ball joint, RH Kugelgelenk, RH	22	K12	85	
81 95301 0040	5336.20.00	Zglob,RH M22x1.5 * Ball joint, RH Kugelgelenk, RH	40	K30	80	
81 95301 0077 81 95301 6134 81 95301 6142 81 95301 6321	5805.20.00	Zglob,RH M24x1.5 Ball joint, RH Kugelgelenk, RH	30	K20	95	
81 95301 0078 81 95301 6304 81 95301 6141 81 95301 6322	5805.10.00	Zglob,LH M24x1.5 Ball joint, LH Kugelgelenk, LH	30	K20	95	
81 95301 0079 81 95301 6139 81 95301 6222	5746.10.00	Zglob,LH M28x1.5 Ball joint, LH Kugelgelenk, LH	30	K22	105	
81 95301 6060 81 95301 6135 81 95301 6140 81 95301 6249	5746.20.00	Zglob,RH M28x1.5 Ball joint, RH Kugelgelenk, RH	30	K22	105	

Originalni broj Cross-Ref.-No. Original Nr.	Br. FAD No. No.	Naziv Designation Bezeichnung	Kugla Ball Ø Größe	Konus Taper Konus	Duzina Length Länge	Skica Figure Bild
81 95301 6070 81 95301 6261	5742.10.00	Zglob,LH M30x1.5 Ball joint, LH Kugelgelenk, LH	40	K26	120	
81 95301 6132	5943.90.00	Izmenljivi podsklop Repair kit Reparatur satz	80	K46		
81 95301 6133	5945.90.00	Izmenljivi podsklop Repair kit Reparatur satz	80	Ø23 >35<	<152>	
81 95301 6184	5856.20.00	Zglob,RH M38x1.5 Ball joint, RH Kugelgelenk, RH	40	K30	120	
81 95301 6219 81 95301 6225 81 95301 6226 81 95301 6267 81 95301 6291	4109.20.00	Zglob,RH M26x1.5 * Ball joint, RH Kugelgelenk, RH	35	K30	80	
81 95301 6219 81 95301 6225 81 95301 6226	6425.20.00	Zglob,RH M26x1.5 * Ball joint, RH Kugelgelenk, RH	40	K30	80	
81 95301 6297	3581.20.00	Zglob,RH M38x1.5 Ball joint, RH Kugelgelenk, RH	50	K38	135	
81 95302 0039	5535.96.00	Izmenljivi podsklop Repair kit Reparatur satz	78.5	Ø16.5 >34<		

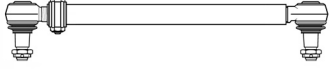
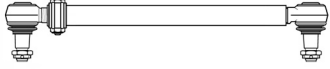
Originalni broj Cross-Ref.-No. Original Nr.	Br. FAD No. Nr.	Naziv Designation Bezeichnung	Kugla Ball Ø Größe	Konus Taper Konus	Duzina Length Länge	Skica Figure Bild
82 95301 0011	7474.20.00	Zglob,RH M24x1.5 * Ball joint, RH Kugelgelenk, RH	40	K30	95	
85 43220 6002	4569.96.00	Izmenljivi podsklop Repair kit Reparatur satz	62	Ø19 >24<	<130>	
85 43270 6001	4151.00.00	V Vodjica mosta Triangular torque rod Dreieckslenker Izmenljivi delovi Parts list 4151.96.00 4483.96.00	70/ 62.5	Ø25/23 >24< <152> <130>	627 RØ50	
85 46610 6012 85 46610 6112 85 46610 6142 85 46610 6212	4146.00.00	Spona upravljacka Drag link Lenkstange Izmenljivi delovi Parts list Stuckliste 5741.20.00	35	K26	860 RØ40	
85 46610 6018 85 46610 6118 85 46610 6152 85 46610 6218	4149.00.00	Spona upravljacka Drag link Lenkstange Izmenljivi delovi Parts list Stuckliste 5743.20.00	40	K30	980 RØ40	
85 46610 6021 85 46610 6121 85 46610 6140	4117.00.00	Spona upravljacka Drag link Lenkstange Izmenljivi delovi Parts list Stuckliste 5746.20.00	30	K22	840 RØ40	

Originalni broj Cross-Ref.-No. Original Nr.	Br. FAD No. Nr.	Naziv Designation Bezeichnung	Kugla Ball Ø Größe	Konus Taper Konus	Duzina Length Länge	Skica Figure Bild
<p>85 46610 6107 85 46610 6143</p>	<p>4143.00.00</p>	<p>Spona upravljacka Drag link Lenkstange</p> <p>Izmenljivi delovi Parts list Stuckliste 5743.20.00</p>	<p>40/35</p>	<p>K30/ 26</p>	<p>860 RØ40</p>	
<p>85 46610 6108 85 46610 6144 85 46610 6208</p>	<p>4138.00.00</p>	<p>Spona upravljacka Drag link Lenkstange</p> <p>Izmenljivi delovi Parts list Stuckliste 5743.20.00</p>	<p>40</p>	<p>K30</p>	<p>896 RØ40</p>	
<p>85 46610 6141 85 46610 6205 85 46610 6231</p>	<p>4141.00.00</p>	<p>Spona upravljacka Drag link Lenkstange</p> <p>Izmenljivi delovi Parts list Stuckliste 5741.20.00</p>	<p>35</p>	<p>K26</p>	<p>787 RØ40</p>	

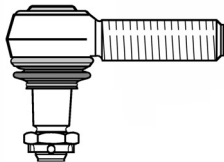
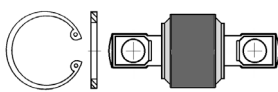
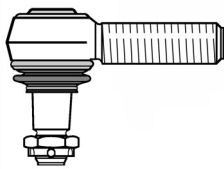
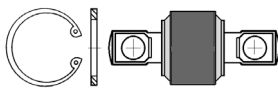
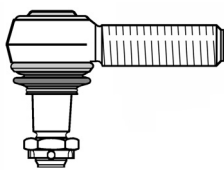
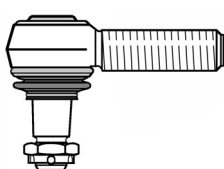
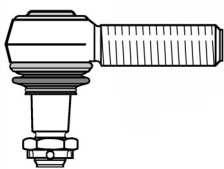
Originalni broj Cross-Ref.-No. Original Nr.	Br. FAD No. Nr.	Naziv Designation Bezeichnung	Kugla Ball Ø Größe	Konus Taper Konus	Duzina Length Länge	Skica Figure Bild
000 268 01 81 000 268 48 89 000 268 52 89	3590.20.00	Zglob,RH M14x1.5 Ball joint, RH Kugelgelenk, RH	22	K12	85	
000 330 00 75	3310.96.00	Izmenljivi podsklop Repair kit Reparatur satz	70	Ø16 >30<	<130>	
000 330 01 48 001 330 88 35 302 330 00 35 302 330 01 35 302 330 02 35 302 330 03 35 350 330 71 35	5741.10.00	Zglob,LH M30x1.5 Ball joint, LH Kugelgelenk, LH	35	K26	115	
000 330 02 07	5117.96.00	Izmenljivi podsklop Repair kit Reparatur satz	62	Ø19 >24<	<130>	
000 330 02 35 000 330 07 35 000 330 68 35 000 330 86 35 000 330 88 35	5805.10.00	Zglob,LH M24x1.5 Ball joint, LH Kugelgelenk, LH	30	K20	95	
000 330 02 48 000 330 32 35 000 338 34 10 000 460 83 48 000 463 34 29 001 330 01 35 001 330 02 35 001 460 44 48	5741.20.00	Zglob,RH M30x1.5 Ball joint, RH Kugelgelenk, RH	35	K26	115	
000 330 03 35 000 330 06 35 000 330 85 35 000 330 87 35 000 463 32 29	5805.10.00	Zglob,RH M24x1.5 Ball joint, RH Kugelgelenk, RH	30	K20	95	

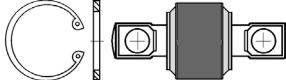
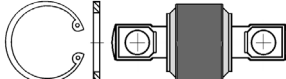
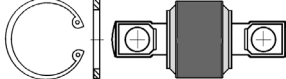
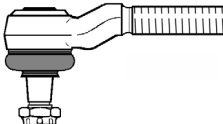
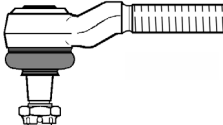
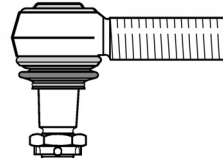
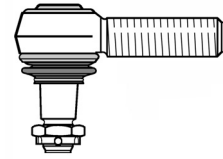
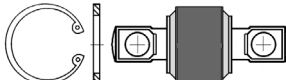
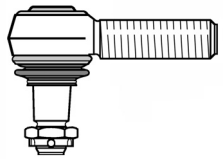
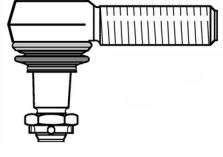
Originalni broj Cross-Ref.-No. Original Nr.	Br. FAD No. Nr.	Naziv Designation Bezeichnung	Kugla Ball Ø Größe	Konus Taper Konus	Duzina Length Länge	Skica Figure Bild
000 330 05 11 000 330 22 11	5128.96.00	Izmenljivi podsklop Repair kit Reparatur satz	55	Ø19 >24<	<130>	
000 330 07 07	5323.96.00	Izmenljivi podsklop Repair kit Reparatur satz	62	Ø17 >24<	<115>	
000 330 07 07	5521.96.00	Izmenljivi podsklop Repair kit Reparatur satz	62	Ø19 >24<	<115>	
000 330 08 35	5797.10.00	Zglob,LH M22x1.5 Ball joint, LH Kugelgelenk, LH	25	K18	160	
000 330 09 35	5797.20.00	Zglob,RH M22x1.5 Ball joint, RH Kugelgelenk, RH	25	K18	160	
000 330 11 35	5733.10.00	Zglob,LH M24x1.5 Ball joint, LH Kugelgelenk, LH	25	K18	95	
000 330 12 35 000 330 13 35 000 330 98 35	4746.20.00	Zglob,RH M24x1.5 Ball joint, RH Kugelgelenk, RH	30	K22	105	
000 330 14 11	3935.96.00	Izmenljivi podsklop Repair kit Reparatur satz	55	Ø17 >20<	<100>	
000 330 14 35	3713.20.00	Zglob,RH M28x1.5 Ball joint, RH Kugelgelenk, RH	30	K22	105	
000 330 14 35 000 330 15 35 000 330 93 35 000 330 95 35	5746.20.00	Zglob,RH M28x1.5 Ball joint, RH Kugelgelenk, RH	30	K22	105	

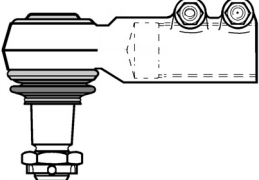
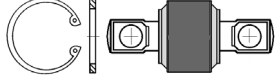
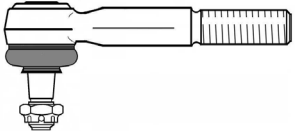
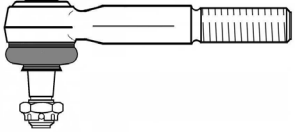
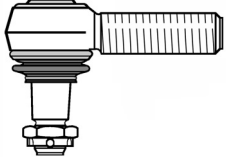
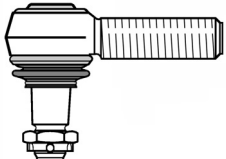
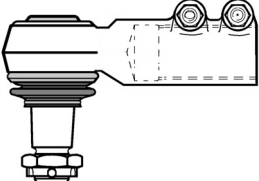
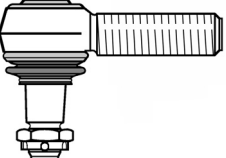
Originalni broj Cross-Ref.-No. Original Nr.	Br. FAD No. Nr.	Naziv Designation Bezeichnung	Kugla Ball Ø Größe	Konus Taper Konus	Duzina Length Länge	Skica Figure Bild
000 330 19 35 000 330 29 35 000 330 41 35 000 330 78 35 000 338 50 29 001 330 22 35 001 330 27 35	5848.10.00	Zglob,LH M35x1.5 * Ball joint, LH Kugelgelenk, LH	35	K26	150	
000 330 20 11	4569.96.00	Izmenljivi podsklop Repair kit Reparatur satz	62	Ø19 >24<	<130>	
000 330 26 35 000 330 69 35 001 330 08 35 001 330 10 35	3692.10.00	Zglob,LH M24x1.5 Ball joint, LH Kugelgelenk, LH	25	K18	160	
000 330 27 35 000 330 70 35 001 330 09 35 001 330 07 35	3692.20.00	Zglob,RH M24x1.5 Ball joint, RH Kugelgelenk, RH	25	K18	160	
000 330 31 35 000 330 81 35 001 330 03 35 001 330 04 35	5748.20.00	Zglob,RH M30x1.5 Ball joint, RH Kugelgelenk, RH	35	K22	115	
000 330 33 35	3713.10.00	Zglob,LH M28x1.5 Ball joint, LH Kugelgelenk, LH	30	K22	105	
000 330 40 35 000 330 49 29 000 330 77 35 001 330 21 35 001 330 26 35	5848.20.00	Zglob,RH M35x1.5 * Ball joint, RH Kugelgelenk, RH	35	K26	150	
000 330 50 35 000 460 21 48 000 460 41 48 000 460 45 48 000 460 85 48 310 330 08 35 310 330 13 35 310 330 04 35	5774.20.00	Zglob,RH M22x1.5 Ball joint, RH Kugelgelenk, RH	30	K18	95	

MERCEDES-BENZ

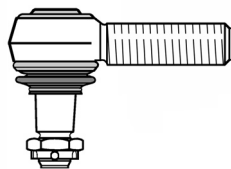
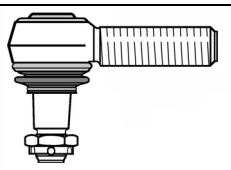
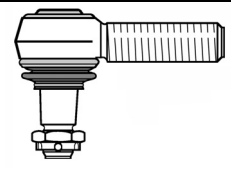
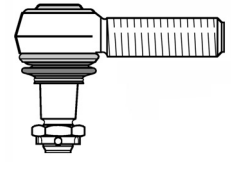
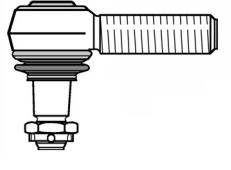
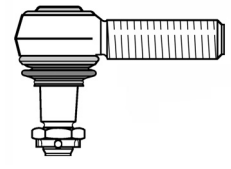
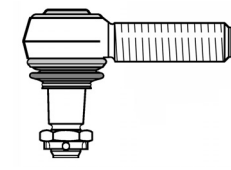
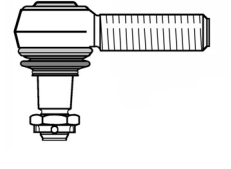

Originalni broj Cross-Ref.-No. Original Nr.	Br. FAD No. Nr.	Naziv Designation Bezeichnung	Kugla Ball Ø Größe	Konus Taper Konus	Duzina Length Länge	Skica Figure Bild
000 330 56 35 000 338 18 10 000 460 43 48 000 460 56 48 310 330 06 35 310 330 10 35 310 330 12 35	7414.20.00	Zglob,RH M24x1.5 Ball joint, RH Kugelgelenk, RH	30	K20	105	
000 330 33 35 000 330 72 35 000 330 94 35 000 330 96 35	5746.10.00	Zglob,LH M28x1.5 Ball joint, LH Kugelgelenk, LH	30	K22	105	
000 338 08 10 000 338 20 10 000 338 50 10 000 338 53 10	1701.10.00	Zglob,LH M14x1.5 Ball joint, LH Kugelgelenk, LH	22	K14	90	
000 338 16 10 001 330 10 35 001 330 12 35 001 330 14 35	5733.20.00	Zglob,RH M24x1.5 Ball joint, RH Kugelgelenk, RH	25	K18	95	
000 338 42 10 000 338 44 10 000 338 61 10	1715.20.00	Zglob,RH M12x1.5 Ball joint, RH Kugelgelenk, RH	22	K12	85	
000 338 43 10 000 338 45 10 000 338 60 10 000 338 62 10	1715.10.00	Zglob,LH M12x1.5 Ball joint, LH Kugelgelenk, LH	22	K12	85	
000 338 51 10	1702.20.00	Zglob,RH M14x1.5 Ball joint, RH Kugelgelenk, RH	22	K14	80	
000 338 54 10	1701.20.00	Zglob,RH M14x1.5 Ball joint, RH Kugelgelenk, RH	22	K14	90	

Originalni broj Cross-Ref.-No. Original Nr.	Br. FAD No. Nr.	Naziv Designation Bezeichnung	Kugla Ball Ø Größe	Konus Taper Konus	Duzina Length Länge	Skica Figure Bild
000 350 01 05	3500.90.00	Izmenljivi podsklop Repair kit Reparatur satz	80	K40		
000 350 01 13	3769.96.00	Izmenljivi podsklop Repair kit Reparatur satz	90	Ø21 >24<	<152>	
000 350 02 05	3956.90.00	Izmenljivi podsklop Repair kit Reparatur satz	65	K38		
000 350 02 13 000 350 03 05 000 350 05 05 000 586 14 33	3755.90.00	Izmenljivi podsklop Repair kit Reparatur satz	65	Ø21 >24<	<152>	
000 350 02 13 000 350 03 05 000 350 05 05 000 586 14 33	3957.90.00	Izmenljivi podsklop Repair kit Reparatur satz	65	Ø21 >24<	<152>	
000 350 04 13 000 586 12 35	3765.96.00	Izmenljivi podsklop Repair kit Reparatur satz	78.5	Ø21 >24<	<152>	
000 350 05 06	5170.96.00	Izmenljivi podsklop Repair kit Reparatur satz	70	Ø19 >30<	<130>	
000 350 06 13 000 586 11 35	3744.96.00	Izmenljivi podsklop Repair kit Reparatur satz	70	Ø21 >24<	<152>	
000 350 10 05	6021.96.00	Izmenljivi podsklop Repair kit Reparatur satz	55	Ø15 >24<	<115>	

Originalni broj Cross-Ref.-No. Original Nr.	Br. FAD No. Nr.	Naziv Designation Bezeichnung	Kugla Ball Ø Größe	Konus Taper Konus	Duzina Length Länge	Skica Figure Bild
000 350 10 05	5847.96.00	Izmenljivi podsklop Repair kit Reparatur satz	70	K45		
000 350 11 05	5705.96.00	Izmenljivi podsklop Repair kit Reparatur satz	95	K45		
000 350 14 05	3950.90.00	Izmenljivi podsklop Repair kit Reparatur satz	65	Ø21/ Ø26	<152>	
000 350 20 05	5367.96.00	Izmenljivi podsklop Repair kit Reparatur satz	55	Ø23 >24<	<130>	
000 350 21 05	3936.96.00	Izmenljivi podsklop Repair kit Reparatur satz	62.5	Ø25 >24<	<152>	
000 350 22 05	4482.96.00	Izmenljivi podsklop Repair kit Reparatur satz	62.5	Ø25 >24<	<130>	
000 350 23 05	4483.96.00	Izmenljivi podsklop Repair kit Reparatur satz	70	Ø25 >24<	<152>	
000 350 24 05	4484.96.00	Izmenljivi podsklop Repair kit Reparatur satz	83	Ø25 >24<	<152>	
000 350 25 05	6023.96.00	Izmenljivi podsklop Repair kit Reparatur satz	62	Ø25 >24<	<130>	

Originalni broj Cross-Ref.-No. Original Nr.	Br. FAD No. Nr.	Naziv Designation Bezeichnung	Kugla Ball Ø Größe	Konus Taper Konus	Duzina Length Länge	Skica Figure Bild
000 350 28 05	4492.96.00	Izmenljivi podsklop Repair kit Reparatur satz	70	Ø25 >24<	<130>	
000 350 29 05	4490.96.00	Izmenljivi podsklop Repair kit Reparatur satz	90	Ø25 >24<	<152>	
000 360 098 524 000 390 098 524 941 330 00 11 SA 508 316/01	3302.00.00	Vodjica mosta Torque rod Achsstrebe Izmenljivi delovi Parts list Stuckliste 3302.90.00 3935.96.00	55	Ø17/ Ø25	754 RØ60	
000 460 01 48 000 460 26 48 000 460 27 48	5742.20.00	Zglob,RH M30x1.5 Ball joint, RH Kugelgelenk, RH	40	K26	120	
000 460 03 48 000 460 28 48 000 460 29 48 001 460 22 48	5743.20.00	Zglob,RH M30x1.5 Ball joint, RH Kugelgelenk, RH	40	K30	120	
000 460 06 48 000 460 12 48 000 460 34 48 000 460 35 48 001 460 14 48	5743.10.00	Zglob,LH M30x1.5 Ball joint, LH Kugelgelenk, LH	40	K30	120	
000 460 17 48	3581.20.00	Zglob,RH M38x1.5 Ball joint, RH Kugelgelenk, RH	50	K38	135	



Originalni broj Cross-Ref.-No. Original Nr.	Br. FAD No. No.	Naziv Designation Bezeichnung	Kugla Ball Ø Größe	Konus Taper Konus	Duzina Length Länge	Skica Figure Bild
000 460 28 05 000 460 36 05 000 460 51 05 625 460 43 05 625 460 77 05	5905.00.00	Spona upravljacka Drag link Lenkstange Izmenljivi delovi Parts list Stuckliste 5855.10.00 5855.20.00	40	K32	600 RØ40	
000 460 39 05 625 460 38 05 625 460 52 05 625 460 79 05	5906.00.00	Spona upravljacka Drag link Lenkstange Izmenljivi delovi Parts list Stuckliste 5855.10.00 5855.20.00	40	K32	520 RØ40	
000 460 41 05 000 460 55 05 625 460 42 05 625 460 78 05	6887.00.00	Spona upravljacka Drag link Lenkstange	40	K32	1242 RØ52	
000 460 43 05 625 460 48 05	4554.00.00	Spona upravljacka Drag link Lenkstange	40	K32	680 RØ42	
000 460 48 48 001 460 06 48	4489.20.00	Zglob,RH M30x1.5 Ball joint, RH Kugelgelenk, RH	40	K32	155	
000 460 49 48	5904.20.00	Zglob,RH M26x1.5 * Ball joint, RH Kugelgelenk, RH	40	K30	95	

Originalni broj Cross-Ref.-No. Original Nr.	Br. FAD No. Nr.	Naziv Designation Bezeichnung	Kugla Ball Ø Größe	Konus Taper Konus	Duzina Length Länge	Skica Figure Bild
000 460 57 48 000 460 60 48 000 460 68 48 000 460 70 48 000 460 75 48 001 460 11 48 001 460 17 48 001 460 24 48 001 460 76 48 001 330 18 35	5855.20.00	Zglob,RH M30x1.5 Ball joint, RH Kugelgelenk, RH	40	K32	120	
000 460 58 48 000 460 69 48 000 460 61 48 000 460 71 48 001 460 05 48 001 460 13 48	5855.10.00	Zglob,LH M30x1.5 Ball joint, LH Kugelgelenk, LH	40	K32	120	
000 460 71 05 000 460 72 05 001 460 67 05	4529.00.00	Spona upravljača Drag link Lenkstange Izmenljivi delovi Parts list Stuckliste 5743.20.00	40	K30	879 RØ42	
000 460 72 48 001 330 48 35 460 330 12 35	1074.20.00	Zglob,RH M20x1.5 Ball joint, RH Kugelgelenk, RH	30	K20	90	
000 460 77 48 001 460 21 48	5369.20.00	Zglob,RH M24x1.5 Ball joint, RH Kugelgelenk, RH	40	K30	120	
000 460 78 48 001 460 20 48	5369.10.00	Zglob,LH M24x1.5 Ball joint, LH Kugelgelenk, LH	40	K30	120	
000 460 84 48 001 460 07 48	4489.10.00	Zglob,LH M30x1.5 Ball joint, LH Kugelgelenk, LH	40	K32	155	

Originalni broj Cross-Ref.-No. Original Nr.	Br. FAD No. No. Nr.	Naziv Designation Bezeichnung	Kugla Ball Ø Größe	Konus Taper Konus	Duzina Length Länge	Skica Figure Bild
000 460 92 05 000 460 93 05 001 460 69 05	4495.00.00	Spona upravljača Drag link Lenkstange Izmenljivi delovi Parts list Stuckliste 5743.20.00	40	K30	873 RØ42	
000 460 95 05 001 460 71 05	4528.00.00	Spona upravljača Drag link Lenkstange Izmenljivi delovi Parts list Stuckliste 5855.20.00	40	K32	904 RØ52	
000 460 98 05 000 460 99 05	4531.00.00	Spona upravljača Drag link Lenkstange Izmenljivi delovi Parts list Stuckliste 5743.20.00	40	K30	889 RØ50	
000 463 23 29 000 463 26 29	5899.20.00	Zglob,RH M22x1.5 * Ball joint, RH Kugelgelenk, RH	40	K26	90	
000 463 24 29 000 463 25 29	5900.20.00	Zglob,RH M22x1.5 Ball joint, RH Kugelgelenk, RH	35	K26	75	
000 463 40 29 000 463 41 29	7523.20.00	Zglob,RH M24x1.5 * Ball joint, RH Kugelgelenk, RH	35	K26	90	
000 586 01 32	3757.90.00	Izmenljivi podsklop Repair kit Reparatur satz	65	Ø19 >24<	<152>	



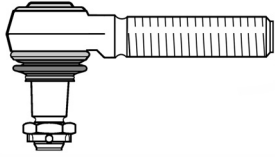
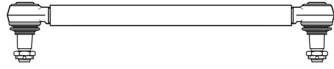
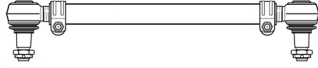
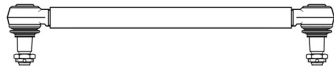

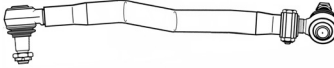
Originalni broj Cross-Ref.-No. Original Nr.	Br. FAD No. Nr.	Naziv Designation Bezeichnung	Kugla Ball Ø Größe	Konus Taper Konus	Duzina Length Länge	Skica Figure Bild
000 586 06 32	3991.95.00	Izmenljivi podsklop Repair kit Reparatur satz	65	K45		
000 586 07 32	3757.95.00	Izmenljivi podsklop Repair kit Reparatur satz	65	Ø19 >24<	<152>	
000 586 09 32	5854.90.00	Izmenljivi podsklop Repair kit Reparatur satz	65	Ø16 >30<	<130>	
000 586 10 35	5846.90.00	Izmenljivi podsklop Repair kit Reparatur satz	65	K38		
000 586 19 33	3500.95.00	Izmenljivi podsklop Repair kit Reparatur satz	80	K40		
001 330 18 35	5856.20.00	Zglob,RH M38x1.5 Ball joint, RH Kugelgelenk, RH	40	K30	120	
001 460 03 05 001 460 04 05	4533.00.00	Spona upravljacka Drag link Lenkstange Izmenljivi delovi Parts list Stuckliste 5855.20.00	40	K32/ K30	840 RØ50	
001 460 05 05 001 460 06 05	4545.00.00	Spona upravljacka Drag link Lenkstange Izmenljivi delovi Parts list Stuckliste 5855.20.00	40	K32	870 RØ42	



Originalni broj Cross-Ref.-No. Original Nr.	Br. FAD No. Nr.	Naziv Designation Bezeichnung	Kugla Ball Ø Größe	Konus Taper Konus	Duzina Length Länge	Skica Figure Bild
001 460 07 05 001 460 08 05 001 460 70 05	4519.00.00	Spona upravljača Drag link Lenkstange Izmenljivi delovi Parts list Stuckliste 5743.20.00	40	K30	888 RØ40	
001 460 11 05 002 460 04 05	4568.00.00	Spona upravljača Drag link Lenkstange	40	K32	710 RØ42	
001 460 13 05 001 460 14 05 002 460 05 05	4551.00.00	Spona upravljača Drag link Lenkstange	40	K32	1095 RØ42	
001 460 15 05 001 460 73 05 375 460 16 05	4548.00.00	Spona upravljača Drag link Lenkstange Izmenljivi delovi Parts list Stuckliste 5855.20.00 5855.10.00	40	K32	733 RØ40	
001 460 15 48 001 460 16 48	4558.20.00	Zglob,RH M26x1.5 * Ball joint, RH Kugelgelenk, RH	40	K32	75	
001 460 29 05 001 460 30 05	3973.00.00	Spona upravljača Drag link Lenkstange Izmenljivi delovi Parts list Stuckliste 5855.20.00	40	K32	830 RØ52	

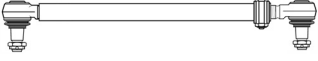

Originalni broj Cross-Ref.-No. Original Nr.	Br. FAD No. Nr.	Naziv Designation Bezeichnung	Kugla Ball Ø Größe	Konus Taper Konus	Duzina Length Länge	Skica Figure Bild
001 460 42 48 001 460 50 48 001 460 85 48	6881.20.00	Zglob,RH M28x1.5 Ball joint, RH Kugelgelenk, RH	35	K28.6	141	
001 460 62 05 002 460 12 05	4504.00.00	Spona upravljacka Drag link Lenkstange	40	K30	1863 RØ42	
001 460 63 05 001 460 85 05	4510.00.00	Spona upravljacka Drag link Lenkstange Izmenljivi delovi Parts list Stuckliste 5743.10.00 5743.20.00	40	K30	758 RØ40	
001 460 86 05 001 460 87 05	4515.00.00	Spona upravljacka Drag link Lenkstange	40	K30	954 RØ42	
001 460 89 05 002 460 13 05	4505.00.00	Spona upravljacka Drag link Lenkstange	40	K30	1255 RØ42	
001 460 96 05	5889.00.00	Spona upravljacka Drag link Lenkstange Izmenljivi delovi Parts list Stuckliste 5743.20.00	40	K30	860 RØ50	

MERCEDES-BENZ

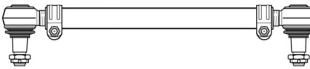
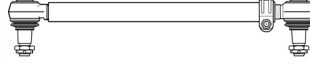
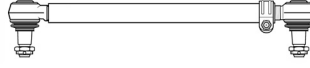

Originalni broj Cross-Ref.-No. Original Nr.	Br. FAD No. Nr.	Naziv Designation Bezeichnung	Kugla Ball Ø Größe	Konus Taper Konus	Duzina Length Länge	Skica Figure Bild
001 460 98 05 001 460 99 05 002 460 64 05	4563.00.00	Spona upravljacka Drag link Lenkstange Izmenljivi delovi Parts list Stuckliste 5743.20.00	40	K30	866 RØ40	
002 460 43 05 002 460 44 05	6881.00.00	Spona upravljacka Drag link Lenkstange Izmenljivi delovi Parts list Stuckliste 6881.20.00	35	K28.6	879 RØ36	
002 460 45 05 002 460 46 05	6882.00.00	Spona upravljacka Drag link Lenkstange Izmenljivi delovi Parts list Stuckliste 6881.20.00	35	K28.6	895 RØ36	
002 460 47 05 002 460 48 05	4527.00.00	Spona upravljacka Drag link Lenkstange Izmenljivi delovi Parts list Stuckliste 5596.20.00	35	K28.6	876 RØ40	
002 460 49 05 002 460 50 05	4539.00.00	Spona upravljacka Drag link Lenkstange Izmenljivi delovi Parts list Stuckliste 5596.20.00	35	K28.6	895 RØ40	
002 460 51 05 002 460 52 05	4549.00.00	Spona upravljacka Drag link Lenkstange Izmenljivi delovi Parts list Stuckliste 5855.20.00	40	K32/30	885 RØ40	

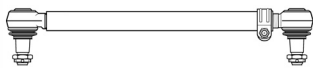
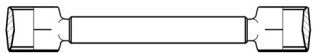
Originalni broj Cross-Ref.-No. Original Nr.	Br. FAD No. Nr.	Naziv Designation Bezeichnung	Kugla Ball Ø Größe	Konus Taper Konus	Duzina Length Länge	Skica Figure Bild
002 460 63 05	4541.00.00	Spona upravljacka Drag link Lenkstange Izmenljivi delovi Parts list Stuckliste 5743.20.00	40	K30	865 RØ40	
002 460 96 05 002 460 97 05	4525.00.00	Spona upravljacka Drag link Lenkstange Izmenljivi delovi Parts list Stuckliste 5596.20.00	35	K28.6	858 RØ40	
080 460 67 05	4516.00.00	Spona upravljacka Drag link Lenkstange Izmenljivi delovi Parts list Stuckliste 5743.10.00 5743.20.00	40	K30	502 RØ40	
300 460 02 05 300 460 03 05 301 460 00 05 301 460 01 05	5875.00.00	Spona upravljacka Drag link Lenkstange Izmenljivi delovi Parts list Stuckliste 5741.20.00	35	K26	658 RØ40	
300 460 04 05 300 460 05 05 301 460 05 05	5835.00.00	Spona upravljacka Drag link Lenkstange Izmenljivi delovi Parts list Stuckliste 5741.20.00	35	K26	1146 RØ40	

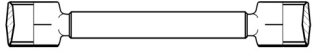
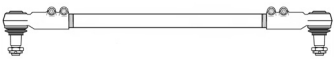

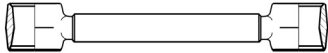
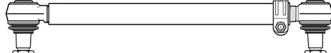
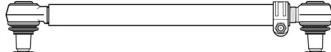
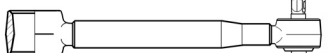
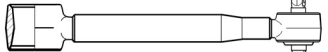

Originalni broj Cross-Ref.-No. Original Nr.	Br. FAD No. No.	Naziv Designation Bezeichnung	Kugla Ball Ø Größe	Konus Taper Konus	Duzina Length Länge	Skica Figure Bild
300 460 06 05 300 460 07 05 305 460 03 05	5283.00.00	Spona upravljača Drag link Lenkstange Izmenljivi delovi Parts list Stuckliste 5741.20.00	35	K26	975 RØ36	
301 330 00 11 600 330 00 11	3605.38.00	Vodjica mosta Torque rod Achsstrebe	83		880 RØ56	
302 330 01 03 302 330 04 03 302 330 07 03	3734.00.00	Poprečna spona Tie rod Spurstange Izmenljivi delovi Parts list Stuckliste 5848.10.00 5848.20.00	35	K26	1678	
302 330 03 03 302 330 06 03 302 330 18 03	3735.00.00	Poprečna spona Tie rod Spurstange Izmenljivi delovi Parts list Stuckliste 5741.20.00	35	K26	1577 RØ40	
302 330 03 11	5786.38.00	Vodjica mosta Torque rod Achsstrebe	83		768 RØ56	
302 330 09 03 302 330 13 03 302 330 15 03 302 330 17 03	5725.00.00	Poprečna spona Tie rod Spurstange Izmenljivi delovi Parts list Stuckliste 5848.10.00 5848.20.00	35	K26	1642 RØ40	

Originalni broj Cross-Ref.-No. Original Nr.	Br. FAD No. Nr.	Naziv Designation Bezeichnung	Kugla Ball Ø Größe	Konus Taper Konus	Duzina Length Länge	Skica Figure Bild
302 330 09 03 302 330 13 03 302 330 15 03 302 330 17 03	5837.00.00	Poprecna spona Tie rod Spurstange Izmenljivi delovi Parts list Stuckliste 5848.10.00 5848.20.00	35	K26	1642 RØ40	
302 330 11 03 302 330 14 03 302 330 16 03	5862.00.00	Poprecna spona Tie rod Spurstange Izmenljivi delovi Parts list Stuckliste 5848.10.00 5848.20.00	35	K26	1624 RØ46	
302 460 05 05 302 460 06 05 302 460 39 05 302 460 40 05 373 460 06 05 373 460 09 05	5728.00.00	Spona upravljacka Drag link Lenkstange Izmenljivi delovi Parts list Stuckliste 5741.20.00	35	K26	687 RØ36	
302 460 14 05 302 460 20 05	5794.00.00	Spona upravljacka Drag link Lenkstange Izmenljivi delovi Parts list Stuckliste 5741.20.00	35	K26	1340 RØ40	
302 460 16 05 302 460 18 05 302 460 24 05 302 460 37 05 302 460 38 05 373 460 08 05	5721.00.00	Spona upravljacka Drag link Lenkstange Izmenljivi delovi Parts list Stuckliste 5741.20.00	35	K26	968 RØ40	
302 460 33 05 302 460 34 05	5727.00.00	Spona upravljacka Drag link Lenkstange Izmenljivi delovi Parts list Stuckliste 5741.20.00	35	K26	987 RØ40	

Originalni broj Cross-Ref.-No. Original Nr.	Br. FAD No. No. Nr.	Naziv Designation Bezeichnung	Kugla Ball Ø Größe	Konus Taper Konus	Duzina Length Länge	Skica Figure Bild
305 330 04 03 305 330 08 03 305 330 10 03 305 330 11 03	5282.00.00	Poprečna spona Tie rod Spurstange Izmenljivi delovi Parts list Stuckliste 5848.10.00 5848.20.00	35	K26	1713 RØ40	
305 330 06 11	5785.38.00	Vodjica mosta Torque rod Achsstrebe	83		689 RØ56	
305 460 04 05	5893.00.00	Spona upravljača Drag link Lenkstange Izmenljivi delovi Parts list Stuckliste 5741.20.00	35	K26	1043 RØ40	
305 460 06 05 357 460 12 05 357 460 13 05	5887.00.00	Spona upravljača Drag link Lenkstange Izmenljivi delovi Parts list Stuckliste 5741.20.00	35	K26	1160 RØ40	
307 330 01 11 357 330 36 11	3310.00.00	Vodjica mosta Torque rod Achsstrebe Izmenljivi delovi Parts list Stuckliste 3310.96.00	70	Ø16 >30<	689 RØ56	
307 330 01 11 357 330 36 11	5854.00.00	Vodjica mosta Torque rod Achsstrebe Izmenljivi delovi Parts list Stuckliste 5854.90.00	65	Ø16 >30< <130>	689 RØ52	

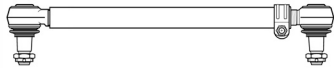
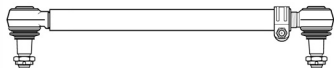

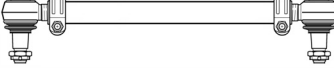

Originalni broj Cross-Ref.-No. Original Nr.	Br. FAD No. No.	Naziv Designation Bezeichnung	Kugla Ball Ø Größe	Konus Taper Konus	Duzina Length Länge	Skica Figure Bild
307 460 00 05 307 460 05 05	5843.00.00	Spona upravljacka Drag link Lenkstange Izmenljivi delovi Parts list Stuckliste 5741.20.00	35	K26	1130 RØ40	
307 460 04 05	5280.00.00	Spona upravljacka Drag link Lenkstange Izmenljivi delovi Parts list Stuckliste 5741.20.00	35	K26	1000 RØ40	
309 330 06 03 309 330 07 03 309 330 08 03 309 330 11 03	5704.00.00	Poprecna spona Tie rod Spurstange Izmenljivi delovi Parts list Stuckliste 5704.10.00 5704.20.00	30	K18	1476 RØ36	
309 330 12 03 309 330 13 03 309 330 14 03 309 330 16 03 309 330 17 03 309 330 18 03 309 330 19 03 309 330 20 03 309 330 21 03	3692.00.00	Poprecna spona Tie rod Spurstange Izmenljivi delovi Parts list Stuckliste 3692.10.00 3692.20.00	25	K18	1476 RØ40	
310 330 00 35 310 330 17 35 310 330 20 35 310 330 24 35	5896.20.00	Zglob,RH M24x1.5 Ball joint, RH Kugelgelenk, RH	30	K20	160	
310 330 01 35 310 330 16 35 310 330 21 35 310 330 25 35	5896.10.00	Zglob,LH M24x1.5 Ball joint, LH Kugelgelenk, LH	30	K20	160	

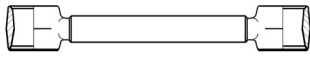
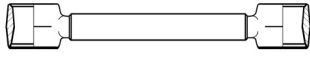
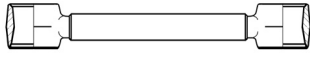
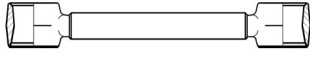
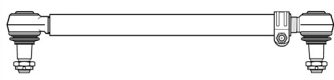
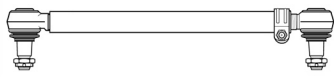
Originalni broj Cross-Ref.-No. Original Nr.	Br. FAD No. Nr.	Naziv Designation Bezeichnung	Kugla Ball Ø Größe	Konus Taper Konus	Duzina Length Länge	Skica Figure Bild
309 460 31 05 309 460 03 05 309 460 04 05 309 460 05 05 309 460 08 05 309 460 09 05 309 460 10 05 309 460 11 05 309 460 12 05 309 460 13 05 309 460 14 05 309 460 20 05 309 460 22 05 309 460 23 05 309 460 24 05 309 460 25 05 309 460 26 05 309 460 29 05 309 460 29 05 601 460 00 05 601 460 01 05 601 460 02 05 601 460 03 05	5775.00.00	Spona upravljača Drag link Lenkstange Izmenljivi delovi Parts list Stuckliste 5774.20.00	30	K18	486 RØ26	
310 330 02 35 310 330 18 35 310 330 22 35 310 330 26 35	5897.20.00	Zglob,RH M24x1.5 Ball joint, RH Kugelgelenk, RH	30	K20	190	
310 330 03 35 310 330 19 35 310 330 23 35 310 330 27 35	5897.10.00	Zglob,LH M24x1.5 Ball joint, LH Kugelgelenk, LH	30	K20	190	
310 330 06 03 310 330 08 03 310 330 10 03 310 330 12 03	5827.00.00	Poprečna spona Tie rod Spurstange Izmenljivi delovi Parts list 5896.10.00 5896.20.00	30	K20	1530 RØ30	
310 330 07 03 310 330 09 03 730.505 730.600	5826.00.00	Poprečna spona Tie rod Spurstange Izmenljivi delovi Parts list Stuckliste 5896.10.00 5896.20.00	30	K20	1476 RØ30	

Originalni broj Cross-Ref.-No. Original Nr.	Br. FAD No. No.	Naziv Designation Bezeichnung	Kugla Ball Ø Größe	Konus Taper Konus	Duzina Length Länge	Skica Figure Bild
313 460 01 05	3918.00.00	Spona upravljacka Drag link Lenkstange Izmenljivi delovi Parts list Stuckliste 7414.20.00	30	K20	490 RØ30	
314 330 03 03	5737.00.00	Poprecna spona Tie rod Spurstange Izmenljivi delovi Parts list Stuckliste 5737.10.00 5737.20.00	25	K18	1400 RØ36	
314 460 03 05	5776.00.00	Spona upravljacka Drag link Lenkstange	30	K18	560 RØ30	
314 460 08 05	5777.00.00	Spona upravljacka Drag link Lenkstange	30	K20	560 RØ30	
316 330 02 03 316 330 06 03 316 330 07 03	5823.00.00	Poprecna spona Tie rod Spurstange Izmenljivi delovi Parts list Stuckliste 5805.10.00 5805.20.00	30	K20	1454 RØ36	
316 460 06 05 316 460 07 05 316 460 08 05 316 460 09 05	5720.00.00	Spona upravljacka Drag link Lenkstange Izmenljivi delovi Parts list Stuckliste 5748.20.00	35	K22	530 RØ36	



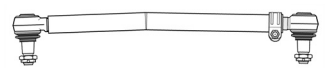
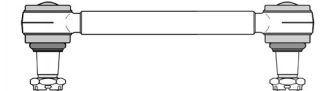
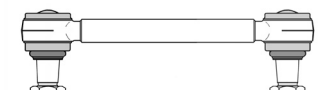



Originalni broj Cross-Ref.-No. Original Nr.	Br. FAD No. Nr.	Naziv Designation Bezeichnung	Kugla Ball Ø Größe	Konus Taper Konus	Duzina Length Länge	Skica Figure Bild
317 330 02 11	3608.38.00	Vodjica mosta Torque rod Achsstrebe	83		820 RØ56	
317 330 04 11 357 330 42 11	3609.38.00	Vodjica mosta Torque rod Achsstrebe	83		960 RØ56	
317 350 06 06 357 330 34 11	3604.38.00	Vodjica mosta Torque rod Achsstrebe	83		585 RØ56	
317 350 07 06 600 330 01 11	3602.38.00	Vodjica mosta Torque rod Achsstrebe	83		724 RØ56	
317 460 57 05 317 460 58 05	5881.00.00	Spona upravljača Drag link Lenkstange Izmenljivi delovi Parts list Stuckliste 5743.20.00	40	K30	910 RØ40	
317 460 61 05	5719.00.00	Spona upravljača Drag link Lenkstange Izmenljivi delovi Parts list Stuckliste 5743.20.00	40	K30	1065 RØ40	

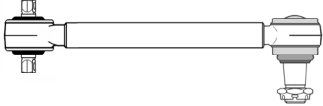

Originalni broj Cross-Ref.-No. Original Nr.	Br. FAD No. Nr.	Naziv Designation Bezeichnung	Kugla Ball Ø Größe	Konus Taper Konus	Duzina Length Länge	Skica Figure Bild
317 460 63 05	5724.00.00	Spona upravljacka Drag link Lenkstange Izmenljivi delovi Parts list Stuckliste 5743.20.00	40	K30	1240 RØ40	
317 460 65 05 317 460 66 05 317 460 70 05 317 460 72 05	5718.00.00	Spona upravljacka Drag link Lenkstange	40	K30	1009 RØ40	
317 460 67 05	5729.00.00	Spona upravljacka Drag link Lenkstange	40	K30	1005 RØ40	
317 460 69 05 317 460 71 05	5882.00.00	Spona upravljacka Drag link Lenkstange Izmenljivi delovi Parts list Stuckliste 5743.20.00	40	K30	600 RØ40	
322 330 10 11 357 330 31 11	3601.38.00	Vodjica mosta Torque rod Achsstrebe	83		775 RØ56	
327 330 01 03 327 330 03 03 327 330 04 03 352 330 02 03 358 330 07 03 358 330 08 03 358 330 00 03	5806.00.00	Poprecna spona Tie rod Spurstange Izmenljivi delovi Parts list Stuckliste 4746.10.00 4746.20.00	30	K22	1648 RØ40	

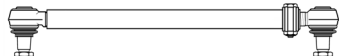

Originalni broj Cross-Ref.-No. Original Nr.	Br. FAD No. Nr.	Naziv Designation Bezeichnung	Kugla Ball Ø Größe	Konus Taper Konus	Duzina Length Länge	Skica Figure Bild
327 460 00 05	5778.00.00	Spona upravljacka Drag link Lenkstange	30	K22	673 RØ32	
327 460 06 05 327 460 16 05	5825.00.00	Spona upravljacka Drag link Lenkstange Izmenljivi delovi Parts list Stuckliste 5748.20.00	30/35	K22	673 RØ36	
335 460 05 05 335 460 07 05 335 460 08 05	3728.00.00	Spona upravljacka Drag link Lenkstange Izmenljivi delovi Parts list Stuckliste 5742.20.00	40/35	K26	985 RØ40	
343 320 16 32 343 320 17 32 343 320 18 32	3756.00.00	Vodjica mosta Torque rod Achsstrebe Izmenljivi delovi Parts list Stuckliste 3991.90.00	65	K45	595 RØ50	
343 320 16 32 343 320 17 32 343 320 18 32	3991.00.00	Vodjica mosta Torque rod Achsstrebe Izmenljivi delovi Parts list Stuckliste 3991.90.00	65	K45	595 RØ50	
343 320 16 32 343 320 17 32 343 320 18 32	3992.00.00	Vodjica mosta Torque rod Achsstrebe Izmenljivi delovi Parts list Stuckliste 3991.90.00	65	K45	595 RØ50	

Originalni broj Cross-Ref.-No. Original Nr.	Br. FAD No. Nr.	Naziv Designation Bezeichnung	Kugla Ball Ø Größe	Konus Taper Konus	Duzina Length Länge	Skica Figure Bild
343 330 01 03 343 330 03 03 343 330 04 03	5731.00.00	Poprecna spona Tie rod Spurstange Izmenljivi delovi Parts list Stuckliste 5743.10.00 5743.20.00	40	K30	1550 RØ50	
343 330 01 03 343 330 03 03 343 330 04 03	5817.00.00	Poprecna spona Tie rod Spurstange Izmenljivi delovi Parts list Stuckliste 5743.10.00 5743.20.00	40	K30	1550 RØ50	
343 460 04 05 343 460 08 05 343 460 10 05 343 460 12 05 343 460 14 05 343 460 15 05	5820.00.00	Spona upravljacka Drag link Lenkstange Izmenljivi delovi Parts list Stuckliste 5743.20.00	40	K30	760 RØ40	
343 586 00 32	3991.90.00	Izmenljivi podsklop Repair kit Reparatur satz	65	K45		
346 330 29 03 346 330 43 03 346 330 44 03	5807.00.00	Poprecna spona Tie rod Spurstange Izmenljivi delovi Parts list Stuckliste 5741.10.00 5741.20.00	35	K26	1560 RØ50	
346 330 49 03 346 330 39 03	5871.00.00	Poprecna spona Tie rod Spurstange Izmenljivi delovi Parts list Stuckliste 5743.20.00	40	K30	1588 RØ58	

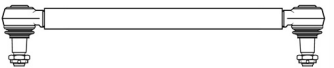
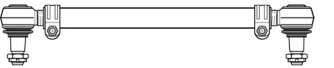
Originalni broj Cross-Ref.-No. Original Nr.	Br. FAD No. No.	Naziv Designation Bezeichnung	Kugla Ball Ø Größe	Konus Taper Konus	Duzina Length Länge	Skica Figure Bild
346 330 45 03 346 330 51 03	3730.00.00	Poprečna spona Tie rod Spurstange Izmenljivi delovi Parts list Stuckliste 5742.20.00	40	K26	1529 RØ50	
346 330 50 03	3739.00.00	Poprečna spona Tie rod Spurstange Izmenljivi delovi Parts list Stuckliste 5741.10.00 5741.20.00	35	K26	1560 RØ50	
352 330 17 03 352 330 25 03 352 330 27 03	5814.00.00	Poprečna spona Tie rod Spurstange Izmenljivi delovi Parts list Stuckliste 5746.20.00	30	K22	1648 RØ50	
352 330 18 03 352 330 26 03 352 330 28 03	5818.00.00	Poprečna spona Tie rod Spurstange Izmenljivi delovi Parts list Stuckliste 5746.20.00	30	K22	1648 RØ50	
352 330 19 03 352 330 20 03 352 330 23 03 352 330 24 03	5804.00.00	Poprečna spona Tie rod Spurstange Izmenljivi delovi Parts list Stuckliste 5746.20.00	30	K22	1626 RØ50	
352 350 03 06	5840.00.00	Vodjica mosta Torque rod Achsstrebe Izmenljivi delovi Parts list Stuckliste 3757.90.00 3991.90.00	65	Ø19 >24< <152> K45	587 RØ50	

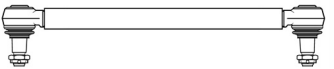
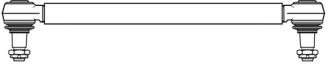

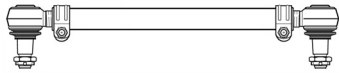
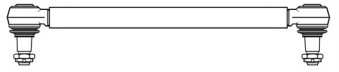
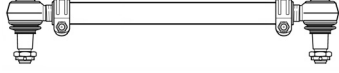
Originalni broj Cross-Ref.-No. Original Nr.	Br. FAD No. Nr.	Naziv Designation Bezeichnung	Kugla Ball Ø Größe	Konus Taper Konus	Duzina Length Länge	Skica Figure Bild
352 350 04 06	3757.00.00	Vodjica mosta Torque rod Achsstrebe Izmenljivi delovi Parts list Stuckliste 3757.90.00 3991.90.00	65	Ø19 >24< <152> K45	595 RØ50	
352 460 10 05 352 460 19 05 352 460 27 05 352 460 44 05 352 460 54 05	3736.00.00	Spona upravljacka Drag link Lenkstange	30	K22	865 RØ40	
352 460 21 05 352 460 29 05 352 460 46 05 352 460 55 05	5816.00.00	Spona upravljacka Drag link Lenkstange	30	K22	668 RØ40	
352 460 22 05 352 460 30 05 352 460 58 05	5740.00.00	Spona upravljacka Drag link Lenkstange	30	K22	668 RØ40	
352 460 23 05 352 460 31 05 352 460 32 05 352 460 48 05 352 460 49 05 352 460 56 05	3914.00.00	Spona upravljacka Drag link Lenkstange Izmenljivi delovi Parts list Stuckliste 5748.20.00	35	K22	625 RØ36	
352 460 28 05 352 460 57 05	3922.00.00	Spona upravljacka Drag link Lenkstange	30	K22	865 RØ40	
352 460 33 05 360 460 21 05 360 460 02 05 360 460 08 05	5779.00.00	Spona upravljacka Drag link Lenkstange Izmenljivi delovi Parts list Stuckliste 5746.20.00	30	K22	678 RØ42	

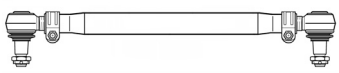
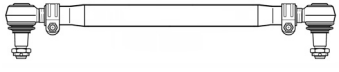
Originalni broj Cross-Ref.-No. Original Nr.	Br. FAD No. Nr.	Naziv Designation Bezeichnung	Kugla Ball Ø Größe	Konus Taper Konus	Duzina Length Länge	Skica Figure Bild
352 460 35 05	3733.00.00	Spona upravljača Drag link Lenkstange Izmenljivi delovi Parts list Stuckliste 5748.20.00	30/35	K22	855 RØ40	
352 460 37 05 352 460 66 05 352 460 71 05	3723.00.00	Spona upravljača Drag link Lenkstange	35	K22	655 RØ36	
353 330 03 03 353 330 04 03 353 330 05 03 353 330 06 03	5805.00.00	Poprečna spona Tie rod Spurstange Izmenljivi delovi Parts list Stuckliste 5805.10.00 5805.20.00	30	K20	1670 RØ36	
355 460 09 05 355 460 35 05 355 460 51 05	3919.00.00	Spona upravljača Drag link Lenkstange Izmenljivi delovi Parts list Stuckliste 5742.20.00	35/40	K26	855 RØ40	
355 460 15 05 355 460 59 05 355 460 60 05	3305.00.00	Spona upravljača Drag link Lenkstange	35	K26	650 RØ40	
355 460 23 05 355 460 28 05 355 460 47 05	4526.00.00	Spona upravljača Drag link Lenkstange	40	K30	618 RØ42	

Originalni broj Cross-Ref.-No. Original Nr.	Br. FAD No. No.	Naziv Designation Bezeichnung	Kugla Ball Ø Größe	Konus Taper Konus	Duzina Length Länge	Skica Figure Bild
356 330 00 03 613 330 00 03	6050.00.00	Poprecna spona Tie rod Spurstange Izmenljivi delovi Parts list Stuckliste 6050.10.00 6050.20.00	40	K30	697 RØ32	
356 330 01 03 613 330 01 03	6054.00.00	Poprecna spona Tie rod Spurstange	40	K30	506 RØ30	
356 330 02 03	6051.00.00	Poprecna spona Tie rod Spurstange Izmenljivi delovi Parts list Stuckliste 6050.10.00 6050.20.00	40	K30	648 RØ32	
356 350 01 06	5708.00.00	Vodjica mosta Torque rod Achsstrebe Izmenljivi delovi Parts list Stuckliste 5705.96.00 6071.96.00	80/62	Ø17 >24< <130> K45	628 RØ50	
356 463 00 15 613 463 00 15	6053.00.00	Spona upravljacka Drag link Lenkstange Izmenljivi delovi Parts list Stuckliste 5743.10.00 5743.20.00	40	K30	1708 RØ58	
356 463 02 15	6052.00.00	Spona upravljacka Drag link Lenkstange Izmenljivi delovi Parts list Stuckliste 5743.10.00 5743.20.00	40	K30	1453 RØ50	

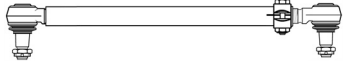
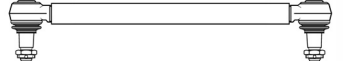
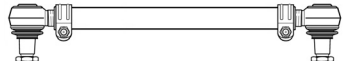
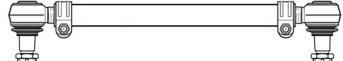

Originalni broj Cross-Ref.-No. Original Nr.	Br. FAD No. No.	Naziv Designation Bezeichnung	Kugla Ball Ø Größe	Konus Taper Konus	Duzina Length Länge	Skica Figure Bild
357 330 00 35	5522.96.00	Izmenljivi podsklop Repair kit Reparatur satz	45	Ø15 >20<	<90>	
357 330 02 03 357 330 04 03 357 330 05 03	3444.00.00	Poprecna spona Tie rod Spurstange Izmenljivi delovi Parts list Stuckliste 5848.10.00 5848.20.00	35	K26	1740 RØ40	
357 330 06 03 357 330 07 03	5976.00.00	Poprecna spona Tie rod Spurstange Izmenljivi delovi Parts list Stuckliste 5741.20.00	35	K26	1725 RØ50	
357 330 11 03 357 330 15 03	6901.00.00	Poprecna spona Tie rod Spurstange Izmenljivi delovi Parts list Stuckliste 5741.10.00 5741.20.00	35	K26	1705 RØ40	
357 330 17 11	3952.00.00	Vodjica mosta Torque rod Achsstrebe Izmenljivi delovi Parts list Stuckliste 3310.96.00	70	Ø16 >30< <130>	960 RØ56	
357 330 19 11 357 330 33 11	6910.00.00	Vodjica mosta Torque rod Achsstrebe Izmenljivi delovi Parts list Stuckliste 3310.96.00	70	Ø16 >30< <130>	713 RØ56	



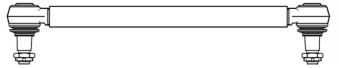
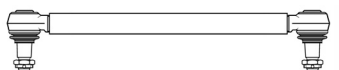
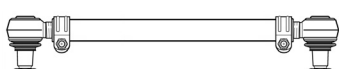
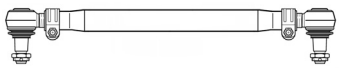
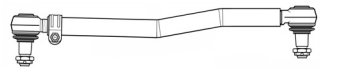
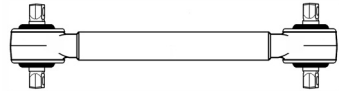

Originalni broj Cross-Ref.-No. Original Nr.	Br. FAD No. Nr.	Naziv Designation Bezeichnung	Kugla Ball Ø Größe	Konus Taper Konus	Duzina Length Länge	Skica Figure Bild
357 333 02 05	5956.00.00	Vodjica mosta Torque rod Achsstrebe Izmenljivi delovi Parts list Stuckliste 5170.96.00	70	Ø19 >30< <130>	750 RØ50	
357 333 04 05	6039.00.00	Vodjica mosta Torque rod Achsstrebe Izmenljivi delovi Parts list Stuckliste 5522.96.00	45	Ø15 >20< <90>	625 RØ36	
357 333 05 05 671 333 02 05	6905.00.00	Vodjica mosta Torque rod Achsstrebe Izmenljivi delovi Parts list Stuckliste 5323.96.00	62	Ø17 >24< <115>	659 RØ50	
357 333 06 05 357 333 09 05	4488.00.00	Vodjica mosta Torque rod Achsstrebe Izmenljivi delovi Parts list Stuckliste 5128.90.00	55	Ø19 >30< <130>	662 RØ50	
357 333 07 05 671 333 04 05	6906.00.00	Vodjica mosta Torque rod Achsstrebe Izmenljivi delovi Parts list Stuckliste 5323.96.00	62	Ø17 >24< <115>	659 RØ50	
357 460 04 05 357 460 10 05 357 460 11 05	5865.00.00	Spona upravljača Drag link Lenkstange Izmenljivi delovi Parts list Stuckliste 5741.20.00	35	K26	988 RØ40	

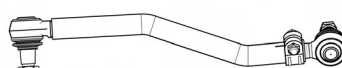
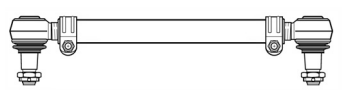
Originalni broj Cross-Ref.-No. Original Nr.	Br. FAD No. No.	Naziv Designation Bezeichnung	Kugla Ball Ø Größe	Konus Taper Konus	Duzina Length Länge	Skica Figure Bild
357 460 14 05 357 460 15 05	3967.00.00	Spona upravljacka Drag link Lenkstange Izmenljivi delovi Parts list Stuckliste 5741.20.00	35	K26	1066 RØ40	
357 460 32 05 671 460 03 05	6902.00.00	Spona upravljacka Drag link Lenkstange	40	K30	920 RØ36	
358 330 01 03 358 330 05 03 381 330 03 03 381 330 05 03 381 330 06 03 381 330 07 03	3738.00.00	Poprecna spona Tie rod Spurstange Izmenljivi delovi Parts list Stuckliste 5746.10.00 5746.20.00	30	K22	1638 RØ46	
358 330 01 03 358 330 05 03 381 330 03 03 381 330 05 03 381 330 06 03 381 330 07 03	5747.00.00	Poprecna spona Tie rod Spurstange Izmenljivi delovi Parts list Stuckliste 5746.10.00 5746.20.00	30	K22	1638 RØ46	
360 460 03 05 360 460 09 05 360 460 22 05	5885.00.00	Spona upravljacka Drag link Lenkstange Izmenljivi delovi Parts list Stuckliste 5746.20.00	35	K22	678 RØ42	
363 460 00 05 363 460 06 05 363 460 07 05	5792.00.00	Spona upravljacka Drag link Lenkstange Izmenljivi delovi Parts list Stuckliste 5742.20.00	40/35	K26	1010 RØ40	

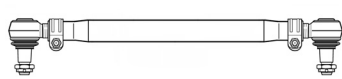
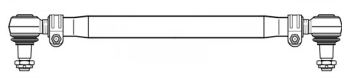
Originalni broj Cross-Ref.-No. Original Nr.	Br. FAD No. Nr.	Naziv Designation Bezeichnung	Kugla Ball Ø Größe	Konus Taper Konus	Duzina Length Länge	Skica Figure Bild
365 460 06 05	3724.00.00	Spona upravljacka Drag link Lenkstange	35	K26	662 RØ36	
366 460 07 05	3725.00.00	Spona upravljacka Drag link Lenkstange	35	K26	1730 RØ40	
366 460 08 05	3726.00.00	Spona upravljacka Drag link Lenkstange Izmenljivi delovi Parts list Stuckliste 5742.10.00 5742.20.00	40	K26	650 RØ40	
371 330 70 03 393 330 00 03 393 330 02 03 393 330 03 03 393 330 04 03	5743.00.00	Poprecna spona Tie rod Spurstange Izmenljivi delovi Parts list Stuckliste 5743.10.00 5743.20.00	40	K30	1615 RØ50	
373 460 03 05 373 460 05 05 373 460 07 05 373 460 36 05 373 460 35 05	5722.00.00	Spona upravljacka Drag link Lenkstange Izmenljivi delovi Parts list Stuckliste 5741.20.00	35	K26	976 RØ40	
381 350 02 06 383 350 00 06	5770.00.00	Vodjica mosta Torque rod Achsstrebe Izmenljivi delovi Parts list Stuckliste 3755.90.00	65	Ø21 >24< <152>	595 RØ50	

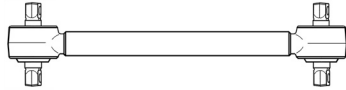
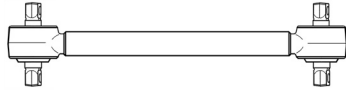
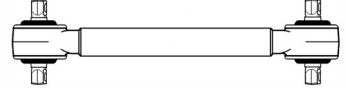

Originalni broj Cross-Ref.-No. Original Nr.	Br. FAD No. Nr.	Naziv Designation Bezeichnung	Kugla Ball Ø Größe	Konus Taper Konus	Duzina Length Länge	Skica Figure Bild
381 350 03 06 385 350 02 06	3697.00.00	Vodjica mosta Torque rod Achsstrebe Izmenljivi delovi Parts list Stuckliste 3755.90.00 3991.90.00	65	Ø21 >24< <152> K45	612 RØ50	
381 350 06 06 652 350 03 06 653 350 01 06	5705.00.00	Vodjica mosta Torque rod Achsstrebe Izmenljivi delovi Parts list Stuckliste 3744.96.00 5705.96.00	78.5/ 70	Ø21 >24< <152> K45	522 RØ52	
381 350 06 06 652 350 03 06 653 350 01 06	5846.00.00	Vodjica mosta Torque rod Achsstrebe Izmenljivi delovi Parts list Stuckliste 3755.90.00 5846.90.00	65	Ø21 >24< <152> K38	522 RØ52	
383 350 03 11 654 330 00 11 654 330 01 11	3431.00.00	Vodjica mosta Torque rod Achsstrebe Izmenljivi delovi Parts list Stuckliste 3431.10.00 3431.20.00	47	Ø15 >22< <110>	550 RØ50	
383 350 01 05 393 350 52 05 393 350 53 05 393 350 54 05 393 350 55 05 653 350 01 05 653 353 00 05 658 350 00 05	3503.00.00	V Vodjica mosta Triangular torque rod Dreieckslenker Izmenljivi delovi Parts list Stuckliste 3755.90.00 3500.90.00	80/65	Ø21 >24< <152> K40	623 RØ60	

Originalni broj Cross-Ref.-No. Original Nr.	Br. FAD No. No.	Naziv Designation Bezeichnung	Kugla Ball Ø Größe	Konus Taper Konus	Duzina Length Länge	Skica Figure Bild
383 460 08 05 383 460 16 05 383 460 24 05 383 460 45 05	5748.00.00	Spona upravljača Drag link Lenkstange Izmenljivi delovi Parts list Stuckliste 5748.20.00	35	K22	890 RØ40	
383 460 14 05	5734.00.00	Spona upravljača Drag link Lenkstange Izmenljivi delovi Parts list Stuckliste 5742.20.00	40	K26	890 RØ40	
385 330 01 03 385 330 12 03 385 330 19 03 385 330 20 03	5730.00.00	Poprečna spona Tie rod Spurstange Izmenljivi delovi Parts list Stuckliste 5741.10.00 5741.20.00	35	K26	1565 RØ46	
385 330 02 03 385 330 08 03 385 330 16 03 385 330 18 03	3968.00.00	Poprečna spona Tie rod Spurstange Izmenljivi delovi Parts list Stuckliste 5741.20.00	35	K26	1635 RØ52	
385 330 04 03 385 330 19 03 385 330 20 03	5869.00.00	Poprečna spona Tie rod Spurstange Izmenljivi delovi Parts list Stuckliste 5743.10.00 5743.20.00	40	K30	1245 RØ50	
385 330 05 03 385 330 06 03 385 330 11 03 385 330 14 03 385 330 15 03	5741.00.00	Poprečna spona Tie rod Spurstange Izmenljivi delovi Parts list Stuckliste 5741.10.00 5741.20.00	35	K26	1611 RØ46	

Originalni broj Cross-Ref.-No. Original Nr.	Br. FAD No. No.	Naziv Designation Bezeichnung	Kugla Ball Ø Größe	Konus Taper Konus	Duzina Length Länge	Skica Figure Bild
385 350 00 06 653 350 00 06	5773.00.00	Vodjica mosta Torque rod Achsstrebe Izmenljivi delovi Parts list Stuckliste 3755.90.00	65	Ø21 >24< <152>	500 RØ50	
385 350 00 06 653 350 00 06	5891.00.00	Vodjica mosta Torque rod Achsstrebe Izmenljivi delovi Parts list Stuckliste 3744.96.00	70	Ø21 >24< <152>	500 RØ50	
385 350 01 06 395 320 03 32	3751.00.00	Vodjica mosta Torque rod Achsstrebe Izmenljivi delovi Parts list Stuckliste 3755.96.00	65	Ø21 >24< <152>	610 RØ50	
385 460 08 05 385 460 20 05 385 460 34 05	5799.00.00	Spona upravljacka Drag link Lenkstange Izmenljivi delovi Parts list Stuckliste 5741.20.00	35	K26	865 RØ42	
387 460 00 05 387 460 48 05 387 460 49 05	5793.00.00	Spona upravljacka Drag link Lenkstange Izmenljivi delovi Parts list Stuckliste 5742.20.00	35/40	K26	880 RØ40	
387 460 00 05	3720.00.00	Spona upravljacka Drag link Lenkstange Izmenljivi delovi Parts list Stuckliste 5742.20.00	35/40	K26	880 RØ40	

Originalni broj Cross-Ref.-No. Original Nr.	Br. FAD No. No.	Naziv Designation Bezeichnung	Kugla Ball Ø Größe	Konus Taper Konus	Duzina Length Länge	Skica Figure Bild
387 460 04 05 387 460 50 05 620 460 00 05 620 460 20 05 620 460 28 05 620 460 37 05	5749.00.00	Spona upravljacka Drag link Lenkstange Izmenljivi delovi Parts list Stuckliste 5743.20.00	40	K30	885 RØ40	
387 460 06 05 387 460 44 05 387 460 45 05	5812.00.00	Spona upravljacka Drag link Lenkstange Izmenljivi delovi Parts list Stuckliste 5742.20.00	35	K26	865 RØ40	
387 460 07 05 387 460 14 05 387 460 32 05 387 460 33 05 647 460 00 05 647 460 01 05	5811.00.00	Spona upravljacka Drag link Lenkstange Izmenljivi delovi Parts list Stuckliste 5743.20.00	40	K30	865 RØ40	
387 460 07 05 387 460 14 05 387 460 32 05 387 460 33 05 647 460 00 05 647 460 01 05	5839.00.00	Spona upravljacka Drag link Lenkstange Izmenljivi delovi Parts list Stuckliste 5743.20.00	40	K30	865 RØ40	
387 460 15 05 387 460 35 05 387 460 36 05 647 460 02 05 647 460 03 05	5860.00.00	Spona upravljacka Drag link Lenkstange Izmenljivi delovi Parts list Stuckliste 5743.20.00	40	K30	865 RØ42	
387 460 15 05 387 460 35 05 387 460 36 05 647 460 02 05 647 460 03 05	5873.00.00	Spona upravljacka Drag link Lenkstange Izmenljivi delovi Parts list Stuckliste 5743.20.00	40	K30	865 RØ40	

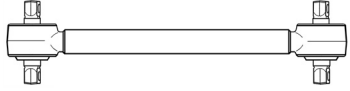
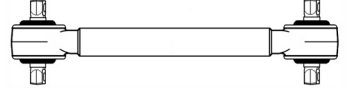
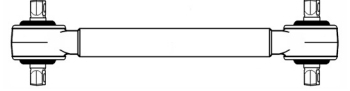
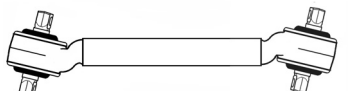

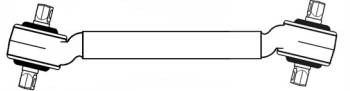
Originalni broj Cross-Ref.-No. Original Nr.	Br. FAD No. Nr.	Naziv Designation Bezeichnung	Kugla Ball Ø Größe	Konus Taper Konus	Duzina Length Länge	Skica Figure Bild
389 320 07 32	5771.00.00	Vodjica mosta Torque rod Achsstrebe Izmenljivi delovi Parts list Stuckliste 3755.90.00	65	Ø21 >24< <152>	582 RØ50	
389 320 08 32	5772.00.00	Vodjica mosta Torque rod Achsstrebe Izmenljivi delovi Parts list Stuckliste 3755.90.00	65	Ø21 >24< <152>	614 RØ50	
389 330 01 03	3722.00.00	Poprečna spona Tie rod Spurstange Izmenljivi delovi Parts list Stuckliste 5741.10.00 5741.20.00	35	K26	1620 RØ50	
391 330 04 03 391 330 07 03 391 330 09 03 391 330 11 03	3716.00.00	Poprečna spona Tie rod Spurstange Izmenljivi delovi Parts list Stuckliste 5741.10.00 5741.20.00	35	K26	1245 RØ40	
391 330 06 03 391 330 08 03 391 330 10 03 391 330 12 03	5872.00.00	Poprečna spona Tie rod Spurstange Izmenljivi delovi Parts list Stuckliste 5741.10.00 5741.20.00	35	K26	1190 RØ46	
391 460 09 05 391 460 17 05 391 460 18 05	3987.00.00	Spona upravljača Drag link Lenkstange	40	K30	1862 RØ40	



Originalni broj Cross-Ref.-No. Original Nr.	Br. FAD No. Nr.	Naziv Designation Bezeichnung	Kugla Ball Ø Größe	Konus Taper Konus	Duzina Length Länge	Skica Figure Bild
393 320 01 32 655 350 00 06 658 350 00 06 658 350 02 06	3742.00.00	Vodjica mosta Torque rod Achsstrebe Izmenljivi delovi Parts list Stuckliste 3755.90.00	65	Ø21 >24< <152>	585 RØ50	
393 320 02 32	3753.00.00	Vodjica mosta Torque rod Achsstrebe Izmenljivi delovi Parts list Stuckliste 3755.90.00	65	Ø21 >24< <152>	627 RØ50	
393 320 03 32	3758.00.00	Vodjica mosta Torque rod Achsstrebe Izmenljivi delovi Parts list Stuckliste 3755.90.00	65	Ø21 >24< <152>	553 RØ50	
393 320 04 32	3754.00.00	Vodjica mosta Torque rod Achsstrebe Izmenljivi delovi Parts list Stuckliste 3755.90.00	65	Ø21 >24< <152>	620 RØ50	
395 320 01 32	3752.00.00	Vodjica mosta Torque rod Achsstrebe Izmenljivi delovi Parts list Stuckliste 3755.90.00	65	Ø21 >24< <152>	570 RØ50	
395 320 14 32	3755.00.00	Vodjica mosta Torque rod Achsstrebe Izmenljivi delovi Parts list Stuckliste 3755.90.00	65	Ø21 >24< <152>	638 RØ50	

Originalni broj Cross-Ref.-No. Original Nr.	Br. FAD No. Nr.	Naziv Designation Bezeichnung	Kugla Ball Ø Größe	Konus Taper Konus	Duzina Length Länge	Skica Figure Bild
395 320 15 32	5739.00.00	Vodjica mosta Torque rod Achsstrebe Izmenljivi delovi Parts list Stuckliste 3755.90.00	65	Ø21 >24< <152>	628 RØ50	
395 350 02 06 659 350 01 06 659 350 24 06	3744.00.00	Vodjica mosta Torque rod Achsstrebe Izmenljivi delovi Parts list Stuckliste 3744.96.00	70	Ø21 >24< <152>	585 RØ50	
395 350 02 06 659 350 01 06 659 350 24 06	5842.00.00	Vodjica mosta Torque rod Achsstrebe Izmenljivi delovi Parts list Stuckliste 3765.96.00	78.5	Ø21 >24< <152>	585 RØ58	
395 350 05 06	3471.00.00	Vodjica mosta Torque rod Achsstrebe Izmenljivi delovi Parts list Stuckliste 3744.96.00	70	Ø21 >24< <152>	595 RØ50	
395 350 06 06	5844.00.00	Vodjica mosta Torque rod Achsstrebe Izmenljivi delovi Parts list Stuckliste 3765.96.00	78.5	Ø21 >24< <152>	595 RØ58	
395 350 07 06 659 350 04 06 659 350 27 06	3745.00.00	Vodjica mosta Torque rod Achsstrebe Izmenljivi delovi Parts list Stuckliste 3744.96.00	70	Ø21 >24< <152>	585 RØ50	

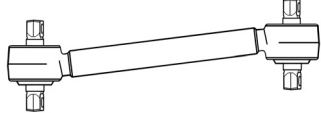
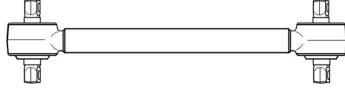
MERCEDES-BENZ

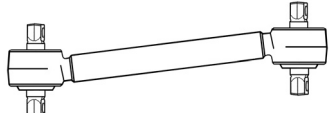
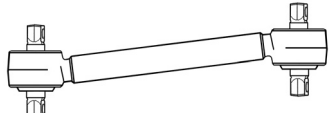
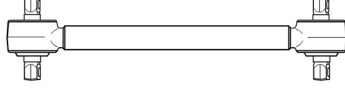

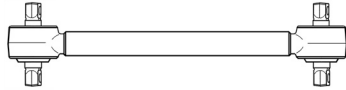
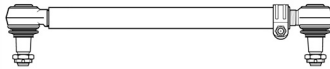
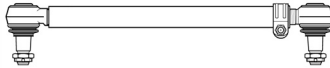

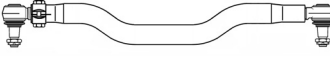

Originalni broj Cross-Ref.-No. Original Nr.	Br. FAD No. Nr.	Naziv Designation Bezeichnung	Kugla Ball Ø Größe	Konus Taper Konus	Duzina Length Länge	Skica Figure Bild
395 350 08 06	3764.00.00	Vodjica mosta Torque rod Achsstrebe Izmenljivi delovi Parts list Stuckliste 3744.96.00	70	Ø21 >24< <152>	595 RØ50	
395 350 10 06 624 350 02 06 659 350 13 06 659 350 36 06	3690.00.00	Vodjica mosta Torque rod Achsstrebe Izmenljivi delovi Parts list Stuckliste 3765.96.00	78.5	Ø21 >24< <152>	635 RØ58	
395 350 10 06 624 350 02 06 659 350 13 06 659 350 36 06	5845.00.00	Vodjica mosta Torque rod Achsstrebe Izmenljivi delovi Parts list Stuckliste 3765.96.00	78.5	Ø21 >24< <152>	629 RØ58	
395 350 11 06 395 350 12 06 659 350 09 06 659 350 32 06	3762.00.00	Vodjica mosta Torque rod Achsstrebe Izmenljivi delovi Parts list Stuckliste 3744.96.00	70	Ø21 >24< <152>	635 RØ50	
395 350 11 06 395 350 12 06 659 350 09 06 659 350 32 06	3767.00.00	Vodjica mosta Torque rod Achsstrebe Izmenljivi delovi Parts list Stuckliste 3765.96.00	78.5	Ø21 >24< <152>	635 RØ58	
395 350 13 06 624 350 05 06 659 350 16 06 659 350 39 06	3691.00.00	Vodjica mosta Torque rod Achsstrebe Izmenljivi delovi Parts list Stuckliste 3765.96.00	78.5	Ø21 >24< <152>	635 RØ58	

Originalni broj Cross-Ref.-No. Original Nr.	Br. FAD No. No. Nr.	Naziv Designation Bezeichnung	Kugla Ball Ø Größe	Konus Taper Konus	Duzina Length Länge	Skica Figure Bild
395 350 13 06 624 350 05 06 659 350 16 06 659 350 39 06	3769.00.00	Vodjica mosta Torque rod Achsstrebe Izmenljivi delovi Parts list Stuckliste 3769.96.00	90	Ø21 >24< <152>	629 RØ58	
396 460 30 05 396 460 48 05	3958.00.00	Spona upravljacka Drag link Lenkstange Izmenljivi delovi Parts list Stuckliste 5743.20.00	40	K30	975 RØ42	
396 460 31 05 396 460 49 05	3959.00.00	Spona upravljacka Drag link Lenkstange Izmenljivi delovi Parts list Stuckliste 5743.20.00	40	K30	1370 RØ50	
396 460 53 05	4512.00.00	Spona upravljacka Drag link Lenkstange	40	K30	777 RØ50	
406 460 01 05	4552.00.00	Spona upravljacka Drag link Lenkstange Izmenljivi delovi Parts list Stuckliste 7414.20.00	30	K20	1015 RØ36	
424 330 03 03	4550.00.00	Poprečna spona Tie rod Spurstange Izmenljivi delovi Parts list Stuckliste 5741.10.00	35	K26	1170 RØ50	

Originalni broj Cross-Ref.-No. Original Nr.	Br. FAD No. Nr.	Naziv Designation Bezeichnung	Kugla Ball Ø Größe	Konus Taper Konus	Duzina Length Länge	Skica Figure Bild
427 460 00 05 427 460 01 05 427 460 03 05 427 460 04 05	4560.00.00	Spona upravljača Drag link Lenkstange Izmenljivi delovi Parts list Stuckliste 5741.20.00	35	K26	882 RØ40	
440 460 03 48 440 460 05 48	3965.20.00	Zglob,RH M18x1.5 * Ball joint, RH Kugelgelenk, RH	30	K22	70	
440 460 03 48	7385.20.00	Zglob,RH M18x1.5 * Ball joint, RH Kugelgelenk, RH	30	K22	70	
444 333 01 27	6409.96.00	Izmenljivi podsklop Repair kit Reparatur satz	55	Ø17 >24<	<115>	
601 330 04 35	5886.20.00	Zglob,RH M20x1.5 Ball joint, RH Kugelgelenk, RH	25	K18	95	
601 330 05 35	5886.10.00	Zglob,LH M20x1.5 Ball joint, LH Kugelgelenk, LH	25	K18	95	
601 460 05 05 601 460 06 05 601 460 07 05 601 460 08 05 601 460 09 05 601 460 10 05 601 460 11 05 601 460 12 05 601 460 13 05 601 460 15 05	5852.00.00	Spona upravljača Drag link Lenkstange Izmenljivi delovi Parts list Stuckliste 5774.20.00	30	K18	483 RØ26	



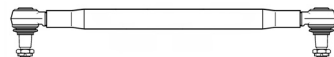
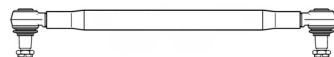

Originalni broj Cross-Ref.-No. Original Nr.	Br. FAD No. No.	Naziv Designation Bezeichnung	Kugla Ball Ø Größe	Konus Taper Konus	Duzina Length Länge	Skica Figure Bild
602 330 00 03 602 330 01 03 602 330 03 03 602 330 52 03	5886.00.00	Poprecna spona Tie rod Spurstange Izmenljivi delovi Parts list Stuckliste 5886.20.00	25	K18	1356 RØ32	
602 330 02 05 602 330 03 05	5895.20.00	Zglob,RH M22x1.5 * Ball joint, RH Kugelgelenk, RH	30	K20	85	
602 330 09 03 602 330 10 03 602 330 53 03 602 330 54 03	3924.00.00	Poprecna spona Tie rod Spurstange Izmenljivi delovi Parts list Stuckliste 5798.10.00 5798.20.00	25	K18	1355 RØ36	
602 330 09 03 602 330 10 03 602 330 53 03 602 330 54 03	5703.00.00	Poprecna spona Tie rod Spurstange Izmenljivi delovi Parts list Stuckliste 5703.10.00 5703.20.00	30	K18	1356 RØ36	
608 330 04 03	1708.00.00	Poprecna spona Tie rod Spurstange	22	K14	312 RØ20	
617 330 02 03 617 330 03 03	3978.00.00	Poprecna spona Tie rod Spurstange Izmenljivi delovi Parts list Stuckliste 5743.10.00 5743.20.00	40	K30	1611 RØ42	

Originalni broj Cross-Ref.-No. Original Nr.	Br. FAD No. No.	Naziv Designation Bezeichnung	Kugla Ball Ø Größe	Konus Taper Konus	Duzina Length Länge	Skica Figure Bild
617 460 00 05 617 460 02 05 617 460 28 05	5821.00.00	Spona upravljača Drag link Lenkstange Izmenljivi delovi Parts list Stuckliste 5742.20.00	40	K26	870 RØ42	
617 460 24 05 617 460 34 05	3969.00.00	Spona upravljača Drag link Lenkstange Izmenljivi delovi Parts list Stuckliste 5743.20.00	40	K30	863 RØ42	
617 460 32 05 617 460 33 05	5890.00.00	Spona upravljača Drag link Lenkstange Izmenljivi delovi Parts list Stuckliste 5743.20.00	40	K30	870 RØ42	
619 460 04 05 619 460 19 05 619 460 45 05	3988.00.00	Spona upravljača Drag link Lenkstange	40	K30	1670 RØ50	
619 460 06 05 619 460 21 05 619 460 47 05	3999.00.00	Spona upravljača Drag link Lenkstange	40	K30	1153 RØ50	
619 460 20 05 619 460 46 05	4546.00.00	Spona upravljača Drag link Lenkstange	40	K30	1553 RØ50	

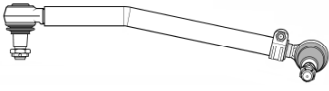
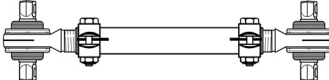
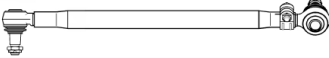
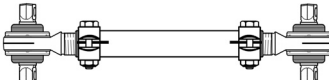
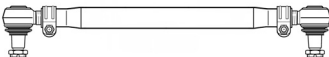
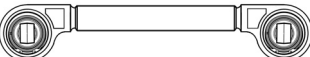

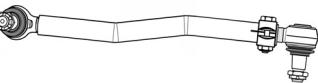

MERCEDES-BENZ

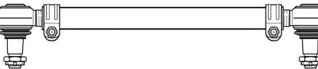

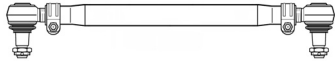

Originalni broj Cross-Ref.-No. Original Nr.	Br. FAD No. Nr.	Naziv Designation Bezeichnung	Kugla Ball Ø Größe	Konus Taper Konus	Duzina Length Länge	Skica Figure Bild
619 460 25 05 619 460 29 05 619 460 52 05	3708.00.00	Spona upravljača Drag link Lenkstange Izmenljivi delovi Parts list Stuckliste 5743.20.00	40	K30	860 RØ42	
620 330 02 11	3433.00.00	Vodjica mosta Torque rod Achsstrebe Izmenljivi delovi Parts list Stuckliste 3431.10.00 3433.20.00	47	Ø15 >22< <110>	600 RØ50	
620 330 03 03 620 330 04 03 620 330 07 03 620 330 08 03	5836.00.00	Poprečna spona Tie rod Spurstange Izmenljivi delovi Parts list Stuckliste 5743.20.00	40	K30	1692 RØ50	
620 330 03 11	3435.00.00	Vodjica mosta Torque rod Achsstrebe Izmenljivi delovi Parts list Stuckliste 3431.10.00 3432.20.00	53/47	Ø18/ Ø15 >24</ >22< <102>/ <110>	600 RØ50	
620 330 05 03 620 330 06 03	5864.00.00	Poprečna spona Tie rod Spurstange Izmenljivi delovi Parts list Stuckliste 5743.10.00 5743.20.00	40	K30	1665 RØ50	
620 350 00 06 620 350 01 06 655 350 03 06	5851.00.00	Vodjica mosta Torque rod Achsstrebe Izmenljivi delovi Parts list Stuckliste 3755.90.00	65	Ø21 >24< <152>	595 RØ62	

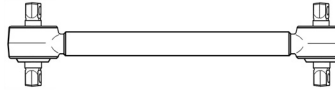
Originalni broj Cross-Ref.-No. Original Nr.	Br. FAD No. No.	Naziv Designation Bezeichnung	Kugla Ball Ø Größe	Konus Taper Konus	Duzina Length Länge	Skica Figure Bild
620 350 00 06 620 350 01 06 655 350 03 06	5858.00.00	Vodjica mosta Torque rod Achsstrebe Izmenljivi delovi Parts list Stuckliste 3744.90.00	70	Ø21 >24< <152>	595 RØ62	
620 460 01 05 620 460 21 05 620 460 38 05 620 460 39 05	5822.00.00	Spona upravljacka Drag link Lenkstange Izmenljivi delovi Parts list Stuckliste 5743.20.00	40	K30	885 RØ40	
620 460 04 05 620 460 08 05 620 460 29 05 620 460 30 05	3971.00.00	Spona upravljacka Drag link Lenkstange Izmenljivi delovi Parts list Stuckliste 5743.20.00	40	K30	865 RØ40	
620 460 24 05 620 460 26 05 620 460 40 05 620 460 41 05	3938.00.00	Spona upravljacka Drag link Lenkstange Izmenljivi delovi Parts list Stuckliste 5743.20.00	40	K30.	900 RØ50	
622 460 02 05 622 460 03 05 622 460 09 05 622 460 10 05	3976.00.00	Spona upravljacka Drag link Lenkstange Izmenljivi delovi Parts list Stuckliste 5743.10.00 5743.20.00	40	K30	700 RØ42	
622 460 04 05 622 460 14 05 622 460 15 05	3975.00.00	Spona upravljacka Drag link Lenkstange Izmenljivi delovi Parts list Stuckliste 5743.10.00 5743.20.00	40	K30	820 RØ42	

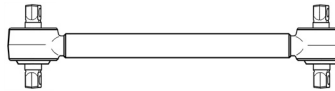
Originalni broj Cross-Ref.-No. Original Nr.	Br. FAD No. No.	Naziv Designation Bezeichnung	Kugla Ball Ø Größe	Konus Taper Konus	Duzina Length Länge	Skica Figure Bild
624 350 01 06 659 350 12 06 659 350 35 06	3759.00.00	Vodjica mosta Torque rod Achsstrebe Izmenljivi delovi Parts list Stuckliste 3744.90.00	70	Ø21 >24< <152>	579 RØ50	
624 350 03 06 659 350 14 06 659 350 37 06	3761.00.00	Vodjica mosta Torque rod Achsstrebe Izmenljivi delovi Parts list Stuckliste 3744.96.00	70	Ø21 >24< <152>	629 RØ50	
625 330 03 03 625 330 20 03 625 330 21 03 625 330 26 03 625 330 27 03 942 330 05 03 942 330 06 03 942 330 09 03	4458.00.00	Poprecna spona Tie rod Spurstange Izmenljivi delovi Parts list Stuckliste 5855.10.00 5855.20.00	40	K32	1565 RØ52	
625 330 04 03	5874.00.00	Poprecna spona Tie rod Spurstange Izmenljivi delovi Parts list Stuckliste 5856.20.00	40	K30	1588 RØ58	
625 330 09 03 625 330 12 03 944 330 02 03	3937.00.00	Poprecna spona Tie rod Spurstange Izmenljivi delovi Parts list Stuckliste 3581.20.00	50	K38	1588 RØ60	
625 330 15 03 625 330 16 03 625 330 24 03 625 330 25 03	3974.00.00	Poprecna spona Tie rod Spurstange Izmenljivi delovi Parts list Stuckliste 5855.10.00 5855.20.00	40	K32	1615 RØ50	



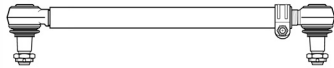
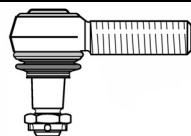

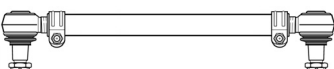
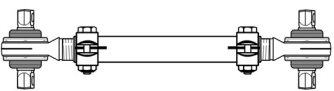
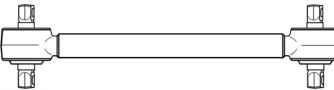
Originalni broj Cross-Ref.-No. Original Nr.	Br. FAD No. Nr.	Naziv Designation Bezeichnung	Kugla Ball Ø Größe	Konus Taper Konus	Duzina Length Länge	Skica Figure Bild
625 330 26 03 625 330 27 03	3977.00.00	Poprecna spona Tie rod Spurstange Izmenljivi delovi Parts list Stuckliste 5855.10.00 5855.20.00	40	K32	1565 RØ50	
625 330 32 03 944 330 17 03	4567.00.00	Poprecna spona Tie rod Spurstange Izmenljivi delovi Parts list Stuckliste 5743.20.00	40	K30	1588 RØ50	
625 350 01 06	3699.00.00	Vodjica mosta Torque rod Achsstrebe Izmenljivi delovi Parts list Stuckliste 3769.90.00	90	Ø21 >24< <152>	645 RØ58	
625 460 25 05	5907.00.00	Spona upravljacka Drag link Lenkstange Izmenljivi delovi Parts list Stuckliste 5743.20.00	40	K30	870 RØ42	
625 460 44 05	3923.00.00	Spona upravljacka Drag link Lenkstange Izmenljivi delovi Parts list Stuckliste 5743.20.00	40	K30	905 RØ42	
628 333 00 03 628 333 00 05 628 333 10 05 628 333 18 05	6885.00.00	Vodjica mosta Torque rod Achsstrebe Izmenljivi delovi Parts list Stuckliste 5942.96.00	70	Ø19 >24< <130>	664 RØ50	

Originalni broj Cross-Ref.-No. Original Nr.	Br. FAD No. Nr.	Naziv Designation Bezeichnung	Kugla Ball Ø Größe	Konus Taper Konus	Duzina Length Länge	Skica Figure Bild
629 350 05 06 629 350 06 06	6197.00.00	Vodjica mosta Torque rod Achsstrebe Izmenljivi delovi Parts list Stuckliste 5170.96.00	70	Ø19 >30< <130>	658 RØ50	
629 350 12 06 629 350 28 06	4566.00.00	Vodjica mosta Torque rod Achsstrebe Izmenljivi delovi Parts list Stuckliste 5942.96.00	70	Ø19 >24< <130>	664 RØ50	
631 330 03 03	1703.00.00	Poprecna spona Tie rod Spurstange Izmenljivi delovi Parts list Stuckliste 1703.10.00 1703.20.00	25	K18	294 RØ24	
631 330 04 03	1705.00.00	Poprecna spona Tie rod Spurstange Izmenljivi delovi Parts list Stuckliste 1074.20.00	30	K20	650 RØ26	
631 330 04 10	1703.10.00	Zglob,LH M18x1.5 Ball joint, LH Kugelgelenk, LH	25	K18	95	
631 330 04 35	1704.20.00	Zglob,RH M20x1.5 Ball joint, RH Kugelgelenk, RH	30	K20	95	
631 330 05 03 631 330 07 03	1704.00.00	Poprecna spona Tie rod Spurstange Izmenljivi delovi Parts list Stuckliste 1704.10.00 1704.20.00	30	K20	300 RØ26	

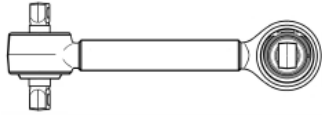
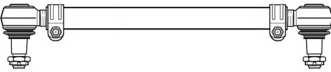

Originalni broj Cross-Ref.-No. Original Nr.	Br. FAD No. No.	Naziv Designation Bezeichnung	Kugla Ball Ø Größe	Konus Taper Konus	Duzina Length Länge	Skica Figure Bild
631 330 06 03	1706.00.00	Poprecna spona Tie rod Spurstange Izmenljivi delovi Parts list Stuckliste 4746.20.00	30	K22	660 RØ30	
631 338 03 10	1703.20.00	Zglob,RH M18x1.5 Ball joint, RH Kugelgelenk, RH	25	K18	95	
631 460 07 05	4536.00.00	Spona upravljacka Drag link Lenkstange Izmenljivi delovi Parts list Stuckliste 1703.20.00	25	K18	1243 RØ36	
634 460 05 05	3492.00.00	Spona upravljacka Drag link Lenkstange Izmenljivi delovi Parts list Stuckliste 5742.10.00 5742.20.00	40	K26	670 RØ40	
653 330 00 11	3432.00.00	Vodjica mosta Torque rod Achsstrebe Izmenljivi delovi Parts list Stuckliste 3432.10.00 3432.20.00	53	Ø18/ Ø18.5 >24< <102>	550 RØ50	
653 350 00 06 385 350 00 06	5891.00.00	Vodjica mosta Torque rod Achsstrebe Izmenljivi delovi Parts list Stuckliste 3744.96.00	70	Ø21 >24< <152>	500 RØ50	

Originalni broj Cross-Ref.-No. Original Nr.	Br. FAD No. No.	Naziv Designation Bezeichnung	Kugla Ball Ø Größe	Konus Taper Konus	Duzina Length Länge	Skica Figure Bild
654 350 04 06 654 350 05 06 654 352 00 05	5706.00.00	Vodjica mosta Torque rod Achsstrebe Izmenljivi delovi Parts list Stuckliste 3744.96.00 5705.96.00	78.5/ 70	Ø21 >24< <152> K45	652 RØ52	
654 350 04 06 654 350 05 06 654 352 00 05	5849.00.00	Vodjica mosta Torque rod Achsstrebe Izmenljivi delovi Parts list Stuckliste 3755.90.00 5846.90.00	65	Ø21 >24< <152> K38	652 RØ52	
655 330 00 11	3434.00.00	Vodjica mosta Torque rod Achsstrebe Izmenljivi delovi Parts list Stuckliste 3432.10.00 3432.20.00	53	Ø18/ Ø18.5 >24< <102>	600 RØ50	
655 350 03 06 620 350 00 06 620 350 01 06	5858.00.00	Vodjica mosta Torque rod Achsstrebe Izmenljivi delovi Parts list Stuckliste 3744.96.00	70	Ø21 >24< <152>	595 RØ62	
659 350 17 06	3760.00.00	Vodjica mosta Torque rod Achsstrebe Izmenljivi delovi Parts list Stuckliste 3744.96.00	70	Ø21 >24< <152>	629 RØ50	
667 460 15 05 667 460 17 05	4534.00.00	Spona upravljača Drag link Lenkstange Izmenljivi delovi Parts list Stuckliste 5746.20.00	30	K22	504 RØ36	

Originalni broj Cross-Ref.-No. Original Nr.	Br. FAD No. Nr.	Naziv Designation Bezeichnung	Kugla Ball Ø Größe	Konus Taper Konus	Duzina Length Länge	Skica Figure Bild
668 460 05 05 668 460 07 05 668 460 09 05 668 460 11 05	3916.00.00	Spona upravljacka Drag link Lenkstange Izmenljivi delovi Parts list Stuckliste 5809.20.00	30	K18	505 RØ30	
668 460 15 05 668 460 17 05 668 460 19 05	3917.00.00	Spona upravljacka Drag link Lenkstange Izmenljivi delovi Parts list Stuckliste 5809.20.00	30	K18	505 RØ30	
668 460 21 05 668 460 22 05	4535.00.00	Spona upravljacka Drag link Lenkstange Izmenljivi delovi Parts list Stuckliste 5798.20.00	25	K18	495 RØ30	
669 330 04 03 669 330 05 03 670 330 00 03 670 330 01 03 670 330 02 03 670 330 03 03	5828.00.00	Poprečna spona Tie rod Spurstange Izmenljivi delovi Parts list Stuckliste 4746.10.00 4746.20.00	30	K22	1594 RØ40	
670 460 08 05 670 460 12 05 670 460 16 05 670 460 20 05	5365.00.00	Spona upravljacka Drag link Lenkstange Izmenljivi delovi Parts list Stuckliste 5746.20.00	30	K22	505 RØ36	
670 460 26 05 670 460 27 05	5363.00.00	Spona upravljacka Drag link Lenkstange Izmenljivi delovi Parts list Stuckliste 5746.20.00	30	K22	495 RØ36	



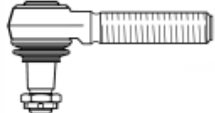
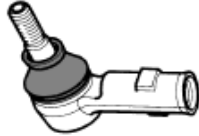
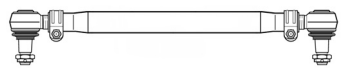

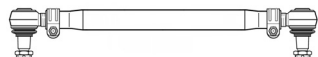

Originalni broj Cross-Ref.-No. Original Nr.	Br. FAD No. No.	Naziv Designation Bezeichnung	Kugla Ball Ø Größe	Konus Taper Konus	Duzina Length Länge	Skica Figure Bild
671 333 01 05	6904.00.00	Vodjica mosta Torque rod Achsstrebe Izmenljivi delovi Parts list Stuckliste 5323.90.00	62	Ø17 >24< <115>	640 RØ50	
671 460 02 05	6900.00.00	Spona upravljača Drag link Lenkstange Izmenljivi delovi Parts list Stuckliste 5743.10.00 5743.20.00	40	K30	1140 RØ40	
673 460 02 05 673 460 04 05 673 460 06 05 673 460 08 05	5888.00.00	Spona upravljača Drag link Lenkstange Izmenljivi delovi Parts list Stuckliste 5748.20.00	35	K22	725 RØ36	
673 460 03 05 673 460 05 05 673 460 07 05 673 460 09 05	5831.00.00	Spona upravljača Drag link Lenkstange Izmenljivi delovi Parts list Stuckliste 5748.20.00	35	K22	725 RØ36	
675 460 10 05 675 460 16 05 675 460 22 05 675 460 28 05	3306.00.00	Spona upravljača Drag link Lenkstange Izmenljivi delovi Parts list Stuckliste 5742.20.00	40/30	K26/ K22	750 RØ40	
675 460 12 05 675 460 18 05 675 460 24 05 675 460 30 05	3972.00.00	Spona upravljača Drag link Lenkstange Izmenljivi delovi Parts list Stuckliste 5742.20.00	40/30	K26/ K22	727 RØ40	

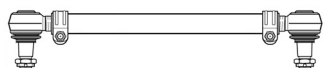

Originalni broj Cross-Ref.-No. Original Nr.	Br. FAD No. Nr.	Naziv Designation Bezeichnung	Kugla Ball Ø Größe	Konus Taper Konus	Duzina Length Länge	Skica Figure Bild
675 460 13 05 675 460 19 05 675 460 25 05 675 460 31 05	5831.00.00	Spona upravljacka Drag link Lenkstange Izmenljivi delovi Parts list Stuckliste 5742.20.00	40/30	K26/ K22	709 RØ40	
676 330 02 03 676 330 04 03 676 330 07 03 676 330 09 03	5829.00.00	Poprecna spona Tie rod Spurstange Izmenljivi delovi Parts list Stuckliste 4746.10.00 4746.20.00	30	K22	1550 RØ40	
676 330 08 03 676 330 10 03	5863.00.00	Poprecna spona Tie rod Spurstange Izmenljivi delovi Parts list Stuckliste 5741.10.00 5741.20.00	35	K26	1546 RØ46	
676 460 01 05 676 460 06 05 676 460 11 05 676 460 15 05	3307.00.00	Spona upravljacka Drag link Lenkstange Izmenljivi delovi Parts list Stuckliste 5742.20.00	40/30	K26	780 RØ42	
676 460 12 05 676 460 16 05	4564.00.00	Spona upravljacka Drag link Lenkstange Izmenljivi delovi Parts list Stuckliste 5742.20.00	40/30	K26	780 RØ40	
677 330 03 03 677 330 04 03	5866.00.00	Poprecna spona Tie rod Spurstange Izmenljivi delovi Parts list Stuckliste 5741.10.00 5741.20.00	35	K26	1562 RØ46	

Originalni broj Cross-Ref.-No. Original Nr.	Br. FAD No. Nr.	Naziv Designation Bezeichnung	Kugla Ball Ø Größe	Konus Taper Konus	Duzina Length Länge	Skica Figure Bild
699 460 16 48	5536.20.00	Zglob,RH M30x1.5 Ball joint, RH Kugelgelenk, RH	40	K30	155	
901 460 01 48 901 460 03 48	1711.20.00	Zglob,RH M16x1.5 * Ball joint, RH Kugelgelenk, RH	25	K20	80	
941 330 00 03 941 330 01 03 941 330 02 03 941 330 03 03	4450.00.00	Poprečna spona Tie rod Spurstange Izmenljivi delovi Parts list Stuckliste 5855.10.00 5855.20.00	40	K32	1735 RØ52	
941 330 00 07	3303.00.00	Vodjica mosta Torque rod Achsstrebe Izmenljivi delovi Parts list Stuckliste 3935.96.00	55	Ø17 >20< <100>	847 RØ60	
942 330 00 03 942 330 01 03 942 330 02 03 942 330 07 03 942 330 11 03	4496.00.00	Poprečna spona Tie rod Spurstange Izmenljivi delovi Parts list Stuckliste 5855.20.00	40	K32	1734 RØ52	
942 330 03 03 942 330 04 03 942 330 16 03	4457.00.00	Poprečna spona Tie rod Spurstange Izmenljivi delovi Parts list Stuckliste 5855.10.00 5855.20.00	40	K32	1644 RØ50	

Originalni broj Cross-Ref.-No. Original Nr.	Br. FAD No. Nr.	Naziv Designation Bezeichnung	Kugla Ball Ø Größe	Konus Taper Konus	Duzina Length Länge	Skica Figure Bild
942 330 08 03 949 330 02 03 949 330 03 03 949 330 09 03	4459.00.00	Poprečna spona Tie rod Spurstange Izmenljivi delovi Parts list Stuckliste 5855.10.00 5855.20.00	40	K32	1625 RØ50	
942 350 05 05 942 350 08 05	4538.00.00	V Vodjica mosta Triangular torque rod Dreieckslenker Izmenljivi delovi Parts list Stuckliste 4538.90.00 4483.96.00	72.5	Ø25/ Ø23 >24< <152>/ <130>	622 RØ50	
942 350 10 05 944 350 00 05 947 350 01 05 947 350 10 05	4480.00.00	V Vodjica mosta Triangular torque rod Dreieckslenker Izmenljivi delovi Parts list 4482.96.00 4483.96.00	70/ 62.5	Ø25 >24< <152>/ <130>	622 RØ50	
945 330 00 03 945 330 01 03 945 330 04 03 945 330 06 03	4553.00.00	Poprečna spona Tie rod Spurstange Izmenljivi delovi Parts list Stuckliste 5079.20.00	40	K32	1735 RØ62	
945 330 00 07	3301.00.00	Vodjica mosta Torque rod Achsstrebe Izmenljivi delovi Parts list Stuckliste 3935.96.00	55	Ø17 >20< <100>	825 RØ62	
945 330 00 11 SA 508 316/02	3304.00.00	Vodjica mosta Torque rod Achsstrebe Izmenljivi delovi Parts list 3935.96.00	55	Ø17 >20< <100>	755 RØ60	



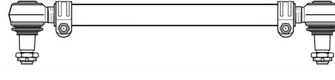

Originalni broj Cross-Ref.-No. Original Nr.	Br. FAD No. Nr.	Naziv Designation Bezeichnung	Kugla Ball Ø Größe	Konus Taper Konus	Duzina Length Länge	Skica Figure Bild
945 330 02 03 945 330 03 03 945 330 05 03	4451.00.00	Poprečna spona Tie rod Spurstange Izmenljivi delovi Parts list Stuckliste 5855.10.00 5855.20.00	40	K32	1465 RØ40	
945 350 01 05 948 350 25 05	6407.00.00	Vodjica mosta Torque rod Achsstrebe Izmenljivi delovi Parts list Stuckliste 3765.96.00	78.5	Ø21 >24< <152>	615 RØ58	
947 350 00 05 948 350 06 05 948 350 12 05 948 350 13 05	3979.00.00	Vodjica mosta Torque rod Achsstrebe Izmenljivi delovi Parts list Stuckliste 3765.96.00	50	Ø21 >24< <152>	565 RØ50	
949 330 04 03 949 330 05 03 949 330 08 03 949 330 14 03	4559.00.00	Poprečna spona Tie rod Spurstange Izmenljivi delovi Parts list Stuckliste 5855.20.00	40	K32	1700 RØ52	
949 330 10 03 949 330 11 03 949 330 17 03	4522.00.00	Poprečna spona Tie rod Spurstange Izmenljivi delovi Parts list Stuckliste 5855.10.00 5855.20.00	40	K32	1596 RØ50	
949 330 12 03 949 330 13 03 949 330 18 03	4511.00.00	Poprečna spona Tie rod Spurstange Izmenljivi delovi Parts list Stuckliste 5855.10.00 5855.20.00	40	K32	1532 RØ50	

Originalni broj Cross-Ref.-No. Original Nr.	Br. FAD No. No.	Naziv Designation Bezeichnung	Kugla Ball Ø Größe	Konus Taper Konus	Duzina Length Länge	Skica Figure Bild
970 330 00 03 970 330 01 03 970 330 02 03 970 330 03 03 970 330 04 03	4471.00.00	Poprečna spona Tie rod Spurstange Izmenljivi delovi Parts list Stuckliste 5855.10.00 5855.20.00	35	K26	1640 RØ40	
970 460 07 05 970 460 09 05	4514.00.00	Spona upravljača Drag link Lenkstange Izmenljivi delovi Parts list Stuckliste 5741.20.00	35	K26	846 RØ42	
970 460 08 05 970 460 10 05	4562.00.00	Spona upravljača Drag link Lenkstange Izmenljivi delovi Parts list Stuckliste 5741.20.00	35	K26	846 RØ42	
972 460 14 05 972 460 16 05	4532.00.00	Spona upravljača Drag link Lenkstange Izmenljivi delovi Parts list Stuckliste 5741.20.00	35	K26	837 RØ40	
972 460 15 05 972 460 17 05	4561.00.00	Spona upravljača Drag link Lenkstange Izmenljivi delovi Parts list Stuckliste 5741.20.00	35	K26	837 RØ40	
972 460 18 05 972 460 20 05	4513.00.00	Spona upravljača Drag link Lenkstange Izmenljivi delovi Parts list Stuckliste 5743.20.00	40	K30	871 RØ50	

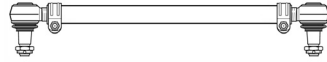
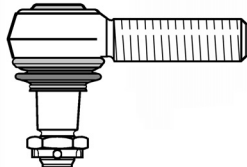
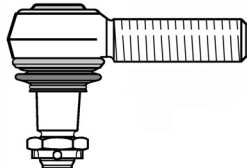
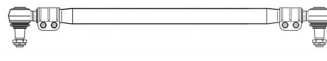
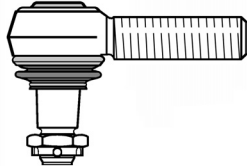
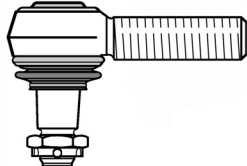

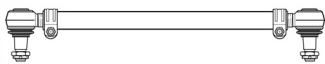
Originalni broj Cross-Ref.-No. Original Nr.	Br. FAD No. No. Nr.	Naziv Designation Bezeichnung	Kugla Ball Ø Größe	Konus Taper Konus	Duzina Length Länge	Skica Figure Bild
974 460 10 05 974 460 12 05	4524.00.00	Spona upravljacka Drag link Lenkstange Izmenljivi delovi Parts list Stuckliste 5743.20.00	40	K30	876 RØ50	
974 460 11 05 974 460 13 05	4565.00.00	Spona upravljacka Drag link Lenkstange Izmenljivi delovi Parts list Stuckliste 5743.20.00	40	K30	894 RØ50	
975 330 02 03 975 330 03 03 975 330 08 03	4474.00.00	Poprečna spona Tie rod Spurstange Izmenljivi delovi Parts list Stuckliste 5743.10.00 5743.20.00	40	K30	1607 RØ40	

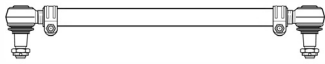
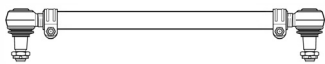
Originalni broj Cross-Ref.-No. Original Nr.	Br. FAD No. Nr.	Naziv Designation Bezeichnung	Kugla Ball Ø Größe	Konus Taper Konus	Duzina Length Länge	Skica Figure Bild
143 929	4440.00.00	Poprecna spona Tie rod Spurstange Izmenljivi delovi Parts list Stuckliste 5743.10.00 5743.20.00	40	K30	1804 RØ52	
144 228	4441.00.00	Poprecna spona Tie rod Spurstange Izmenljivi delovi Parts list Stuckliste 5743.10.00 5743.20.00	40	K30	1654 RØ52	
377 740	5928.00.00	Spona upravljacka Drag link Lenkstange Izmenljivi delovi Parts list Stuckliste 5743.20.00	40	K30	857 RØ40	
4922-02/1962 91842	4345.00.00	Poprecna spona Tie rod Spurstange Izmenljivi delovi Parts list Stuckliste 5743.10.00 5743.20.00	40	K30	1537 RØ50	
619 687	7720.20.00	Zglob,RH M30x1,5 Ball joint, RH Kugelgelenk, RH	40	K31.5	120	
654 136	5746.10.00	Zglob,LH M28x1,5 Ball joint, LH Kugelgelenk, LH	30	K22	105	

Originalni broj Cross-Ref.-No. Original Nr.	Br. FAD No. No.	Naziv Designation Bezeichnung	Kugla Ball Ø Größe	Konus Taper Konus	Duzina Length Länge	Skica Figure Bild
660 856	3582.00.00	Poprecna spona Tie rod Spurstange Izmenljivi delovi Parts list Stuckliste 5743.10.00 5743.20.00	40	K30	1550 RØ42	
660 857	5743.10.00	Zglob,LH M30x1,5 Ball joint, LH Kugelgelenk, LH	40	K30	120	
660 858	5743.20.00	Zglob,RH M30x1,5 Ball joint, RH Kugelgelenk, RH	40	K30	120	
660 915	3581.00.00	Poprecna spona Tie rod Spurstange Izmenljivi delovi Parts list Stuckliste 3581.10.00 3581.20.00	50	K38	1485 RØ50	
660 916	3581.10.00	Zglob,LH M38x1,5 Ball joint, LH Kugelgelenk, LH	50	K38	135	
660 917	3581.20.00	Zglob,RH M38x1,5 Ball joint, RH Kugelgelenk, RH	50	K38	135	

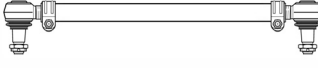
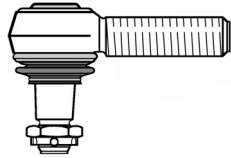
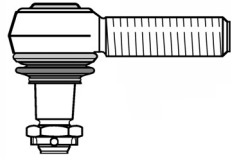
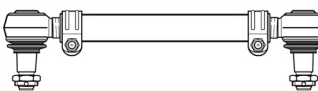
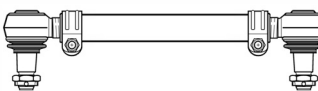
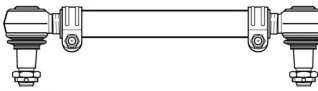
Originalni broj Cross-Ref.-No. Original Nr.	Br. FAD No. No. Nr.	Naziv Designation Bezeichnung	Kugla Ball Ø Größe	Konus Taper Konus	Duzina Length Länge	Skica Figure Bild
660 976	3586.00.00	Poprecna spona Tie rod Spurstange Izmenljivi delovi Parts list Stuckliste 5741.10.00 5741.20.00	35	K26	1690 RØ40	
660 977	3584.00.00	Poprecna spona Tie rod Spurstange Izmenljivi delovi Parts list Stuckliste 5743.10.00 5743.20.00	40	K30	1645 RØ42	
665 178	3587.00.00	Poprecna spona Tie rod Spurstange Izmenljivi delovi Parts list Stuckliste 5746.10.00 5746.20.00	30	K22	1460 RØ36	
665 196	3579.00.00	Poprecna spona Tie rod Spurstange Izmenljivi delovi Parts list Stuckliste 3585.10.00 3585.20.00	40	K31.5	1669 RØ52	
665 197	3573.00.00	Poprecna spona Tie rod Spurstange Izmenljivi delovi Parts list Stuckliste 3585.20.00	40	K31.5	1590 RØ52	

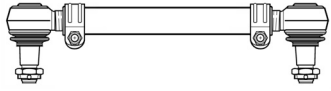
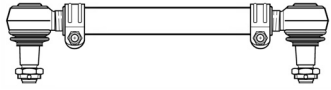
Originalni broj Cross-Ref.-No. Original Nr.	Br. FAD No. Nr.	Naziv Designation Bezeichnung	Kugla Ball Ø Größe	Konus Taper Konus	Duzina Length Länge	Skica Figure Bild
678 612	3576.00.00	Poprecna spona Tie rod Spurstange Izmenljivi delovi Parts list Stuckliste 5743.10.00 5743.20.00	40	K30	1530 RØ42	
678 621	5741.10.00	Zglob,LH M30x1,5 Ball joint, LH Kugelgelenk, LH	35	K26	115	
678 622	5741.20.00	Zglob,RH M30x1,5 Ball joint, RH Kugelgelenk, RH	35	K26	115	
683 795	3595.00.00	Poprecna spona Tie rod Spurstange Izmenljivi delovi Parts list Stuckliste 3581.10.00 3582.20.00	50	K38	1706 RØ50	
685 201	3593.00.00	Poprecna spona Tie rod Spurstange Izmenljivi delovi Parts list Stuckliste 5743.10.00 5743.20.00	40	K30	1655 RØ42	
699 432	3597.00.00	Poprecna spona Tie rod Spurstange Izmenljivi delovi Parts list Stuckliste 5743.10.00 5743.20.00	40	K30	1760 RØ42	

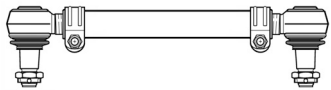
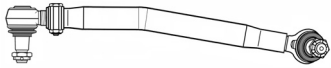
Originalni broj Cross-Ref.-No. Original Nr.	Br. FAD No. No. Nr.	Naziv Designation Bezeichnung	Kugla Ball Ø Größe	Konus Taper Konus	Duzina Length Länge	Skica Figure Bild
700 875	3598.00.00	Poprecna spona Tie rod Spurstange Izmenljivi delovi Parts list Stuckliste 5741.10.00 5741.20.00	35	K26	1550 RØ40	
737 710	3599.00.00	Poprecna spona Tie rod Spurstange Izmenljivi delovi Parts list Stuckliste 3581.10.00 3581.20.00	50	K38	1590 RØ50	
783.24-3143-000 86397	4337.00.00	Poprecna spona Tie rod Spurstange Izmenljivi delovi Parts list Stuckliste 3581.10.00 3581.20.00	50	K38	1496 RØ52	
832.00.3183.000	5198.00.00	Poprecna spona Tie rod Spurstange Izmenljivi delovi Parts list Stuckliste 5743.10.00 5743.20.00	40	K30	1654 RØ50	
836.01.3504.000	5914.00.00	Spona upravljaca Drag link Lenkstange Izmenljivi delovi Parts list Stuckliste 5743.20.00	40	K30	857 RØ40	

Originalni broj Cross-Ref.-No. Original Nr.	Br. FAD No. Nr.	Naziv Designation Bezeichnung	Kugla Ball Ø Größe	Konus Taper Konus	Duzina Length Länge	Skica Figure Bild
839.53.3143.000 83757	4333.00.00	Poprecna spona Tie rod Spurstange Izmenljivi delovi Parts list Stuckliste 5743.10.00 5743.20.00	40	K30	1514 RØ50	
832.45	3583.00.00	Poprecna spona Tie rod Spurstange Izmenljivi delovi Parts list Stuckliste 3583.10.00 3583.20.00	40	K30	1645 RØ42	
900.20/21	3585.00.00	Poprecna spona Tie rod Spurstange Izmenljivi delovi Parts list Stuckliste 3585.10.00 3585.20.00	40	K31.5	1530 RØ42	
900.81	3588.00.00	Poprecna spona Tie rod Spurstange Izmenljivi delovi Parts list Stuckliste 3585.10.00 3585.20.00	40	K31.5	1600 RØ42	
91720	3646.00.00	Poprecna spona Tie rod Spurstange Izmenljivi delovi Parts list Stuckliste 5743.10.00 5743.20.00	40	K30	1504 RØ42	

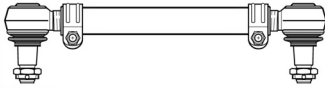
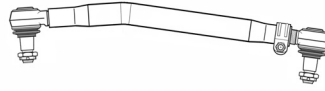
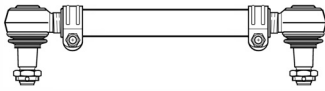
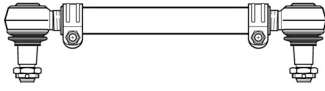
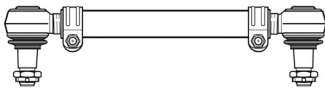
Originalni broj Cross-Ref.-No. Original Nr.	Br. FAD No. Nr.	Naziv Designation Bezeichnung	Kugla Ball Ø Größe	Konus Taper Konus	Duzina Length Länge	Skica Figure Bild
99656	4387.00.00	Poprecna spona Tie rod Spurstange Izmenljivi delovi Parts list Stuckliste 5746.10.00 5746.20.00	30	K22	1703.5 RØ36	
997 324	5927.00.00	Spona upravljacka Drag link Lenkstange Izmenljivi delovi Parts list Stuckliste 5743.20.00	40	K30	857 RØ40	
A4815-20	4334.00.00	Spona upravljacka Drag link Lenkstange Izmenljivi delovi Parts list Stucklist 5746.10.00 5746.20.00	30	K22	503 RØ40	
A4815-21	4335.00.00	Spona upravljacka Drag link Lenkstange Izmenljivi delovi Parts list Stuckliste 5746.10.00 5746.20.00	30	K22	355 RØ40	
A4815-22	4336.00.00	Spona upravljacka Drag link Lenkstange Izmenljivi delovi Parts list Stuckliste 5746.10.00 5746.20.00	30	K22	980 RØ40	

Originalni broj Cross-Ref.-No. Original Nr.	Br. FAD No. Nr.	Naziv Designation Bezeichnung	Kugla Ball Ø Größe	Konus Taper Konus	Duzina Length Länge	Skica Figure Bild
00 00 566 157	5980.00.00	Vodjica mosta Torque rod Achsstrebe Izmenljivi delovi Parts list Stuckliste 5980.90.00 5981.90.00	65	Ø32 K45	510 RØ50	
00 00 691 970	3283.00.00	Vodjica mosta Torque rod Achsstrebe Izmenljivi delovi Parts list Stuckliste 5506.96.00	55	Ø25	620 RØ50	
00 00 745 019	5981.00.00	Vodjica mosta Torque rod Achsstrebe Izmenljivi delovi Parts list Stuckliste 5981.90.00 5982.90.00	65	K45 Ø19 >30< <145>	475 RØ50	
00 03 401 149 50 00 803 461	5998.20.00	Zglob,RH M22x1.5 Ball joint, RH Kugelgelenk, RH	30	K20	95	
00 03 401 150 50 00 803 462	5998.10.00	Zglob,LH M22x1.5 Ball joint, LH Kugelgelenk, LH	30	K20	95	
00 03 401 170 50 00 288 361 50 01 832 581	5743.10.00	Zglob,LH M30x1.5 Ball joint, LH Kugelgelenk, LH	40	K30	120	

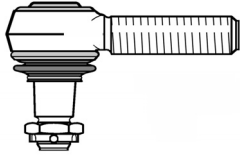
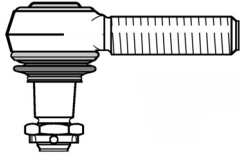
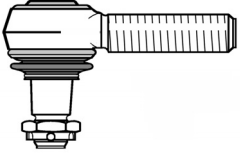
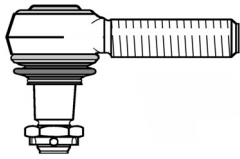
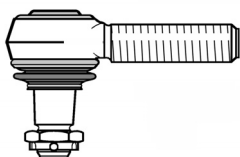
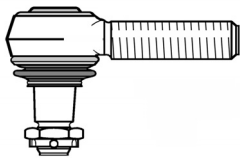
Originalni broj Cross-Ref.-No. Original Nr.	Br. FAD No. No.	Naziv Designation Bezeichnung	Kugla Ball Ø Größe	Konus Taper Konus	Duzina Length Länge	Skica Figure Bild
00 03 401 206 50 01 832 579	5856.10.00	Zglob,LH M38x1.5 Ball joint, LH Kugelgelenk, LH	40	K30	120	
00 03 401 207 50 01 831 481 50 01 832 580	5856.20.00	Zglob,RH M38x1.5 Ball joint, RH Kugelgelenk, RH	40	K30	120	
00 03 406 169 00 03 406 236 00 03 406 251 00 03 406 254 00 03 406 260 00 03 406 261 50 00 288 360 50 00 590 236 50 00 804 824 77 01 011 412	5743.20.00	Zglob,RH M30x1.5 Ball joint, RH Kugelgelenk, RH	40	K30	120	
00 03 406 212 00 03 406 253 50 00 242 159 50 00 295 214 50 00 812 483 50 01 850 549 77 01 016 946	5741.20.00	Zglob,RH M30x1.5 Ball joint, RH Kugelgelenk, RH	35	K26	115	
00 03 406 213 00 03 406 218 50 00 295 215 50 01 850 550 50 01 852 263	5741.10.00	Zglob,LH M30x1.5 Ball joint, LH Kugelgelenk, LH	35	K26	115	
00 03 406 252 50 00 807 554 50 00 814 097 50 01 844 136	5805.20.00	Zglob,RH M24x1.5 Ball joint, RH Kugelgelenk, RH	30	K20	95	

Originalni broj Cross-Ref.-No. Original Nr.	Br. FAD No. No.	Naziv Designation Bezeichnung	Kugla Ball Ø Größe	Konus Taper Konus	Duzina Length Länge	Skica Figure Bild
00 23 123 159	5987.00.00	Vodjica mosta Torque rod Achsstrebe Izmenljivi delovi Parts list Stuckliste 5980.90.00	65	Ø32	507 RØ52	
00 23 123 220 1 151 394	3289.00.00	Vodjica mosta Torque rod Achsstrebe Izmenljivi delovi Parts list Stuckliste 5755.96.00	70	Ø19 >30< <145>	560 RØ50	
00 23 123 225 00 23 123 240 50 01 826 368	5760.00.00	Poprečna spona Tie rod Spurstange Izmenljivi delovi Parts list Stuckliste 5743.20.00	40	K30	1470 RØ50	
00 23 123 233	5996.00.00	Spona upravljača Drag link Lenkstange Izmenljivi delovi Parts list Stuckliste 5743.20.00	40	K30	1835 RØ40	
00 23 123 237 1 151 395	5755.00.00	Vodjica mosta Torque rod Achsstrebe Izmenljivi delovi Parts list Stuckliste 5755.96.00	70	Ø19 >30< <145>	535 RØ50	
00 23 123 238 1 151 396	5757.00.00	Vodjica mosta Torque rod Achsstrebe Izmenljivi delovi Parts list Stuckliste 5755.96.00	70	Ø19 >30< <145>	535 RØ50	

Originalni broj Cross-Ref.-No. Original Nr.	Br. FAD No. No.	Naziv Designation Bezeichnung	Kugla Ball Ø Größe	Konus Taper Konus	Duzina Length Länge	Skica Figure Bild
00 23 123 247 50 00 748 868 50 00 874 577 50 10 130 453	3298.00.00	Spona upravljacka Drag link Lenkstange Izmenljivi delovi Parts list Stuckliste 5743.20.00	40	K30	1000 RØ52	
00 23 123 252 50 00 788 392	5983.00.00	Vodjica mosta Torque rod Achsstrebe Izmenljivi delovi Parts list Stuckliste 5982.90.00 5983.90.00	65	Ø19 >30< <145>	467 RØ50	
00 23 123 253 50 00 750 976 50 00 783 574 50 01 850 530 50 10 064 641 50 10 094 838 50 10 094 941	5985.00.00	Vodjica mosta Torque rod Achsstrebe Izmenljivi delovi Parts list Stuckliste 5982.90.00	65	Ø19 >30< <145>	575 RØ52	
00 23 123 253 50 00 750 976 50 00 783 574 50 01 850 530 50 10 064 641 50 10 094 838 50 10 094 941	5982.00.00	Vodjica mosta Torque rod Achsstrebe Izmenljivi delovi Parts list Stuckliste 5982.90.00	65	Ø19 >30< <145>	575 RØ50	
00 23 123 262	4661.00.00	Spona upravljacka Drag link Lenkstange Izmenljivi delovi Parts list Stuckliste 3307.20.00	50	K30	505 RØ50	

Originalni broj Cross-Ref.-No. Original Nr.	Br. FAD No. No.	Naziv Designation Bezeichnung	Kugla Ball Ø Größe	Konus Taper Konus	Duzina Length Länge	Skica Figure Bild
00 23 123 265	5759.00.00	Spona upravljacka Drag link Lenkstange Izmenljivi delovi Parts list Stuckliste 5743.20.00	40	K30	797 RØ52	
00 23 123 275	5993.00.00	Vodjica mosta Torque rod Achsstrebe Izmenljivi delovi Parts list Stuckliste 5755.96.00	70	Ø19 >30< <145>	535 RØ50	
00 23 162 046 50 00 516 214 50 10 144 543	3590.20.00	Zglob,RH 14x1.5 Ball joint, RH Kugelgelenk, RH	22	K12	85	
23 123 224 50 10 145 077	4666.00.00	Poprečna spona Tie rod Spurstange Izmenljivi delovi Parts list Stuckliste 5856.10.00 5856.20.00	40	K30	1700 RØ50	
23 123 256	5995.00.00	Vodjica mosta Torque rod Achsstrebe Izmenljivi delovi Parts list Stuckliste 5982.90.00	65	Ø19 >30< <145>	560 RØ50	
50 00 027 957 50 00 810 038	5910.00.00	Vodjica mosta Torque rod Achsstrebe Izmenljivi delovi Parts list Stuckliste 5170.96.00	70	Ø19 >30<	565 RØ50	



Originalni broj Cross-Ref.-No. Original Nr.	Br. FAD No. No.	Naziv Designation Bezeichnung	Kugla Ball Ø Größe	Konus Taper Konus	Duzina Length Länge	Skica Figure Bild
50 00 145 581 50 00 791 032 50 10 308 215 50 10 791 275	4673.00.00	Spona upravljacka Drag link Lenkstange Izmenljivi delovi Parts list Stuckliste 5743.10.00 5743.20.00	40	K30	1650 RØ50	
50 00 559 336 50 00 823 947 50 00 823 997	5746.10.00	Zglob,LH M28x1.5 Ball joint, LH Kugelgelenk, LH	30	K22	105	
50 00 613 837	4679.00.00	Poprecna spona Tie rod Spurstange Izmenljivi delovi Parts list Stuckliste 5741.10.00 5741.20.00	35	K26	1510 RØ40	
50 00 725 267 50 10 144 549 50 10 144 552	3296.00.00	Spona upravljacka Drag link Lenkstange Izmenljivi delovi Parts list Stuckliste 5743.20.00	40	K30	975 RØ52	
50 00 785 429	3292.00.00	Spona upravljacka Drag link Lenkstange Izmenljivi delovi Parts list Stuckliste 5743.20.00	40	K30	915 RØ52	
50 00 786 532	4660.00.00	Spona upravljacka Drag link Lenkstange Izmenljivi delovi Parts list Stuckliste 5743.20.00	40	K30	485 RØ40	

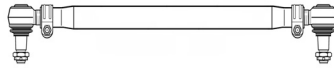
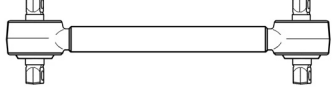
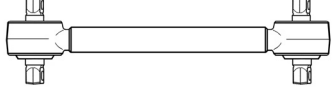
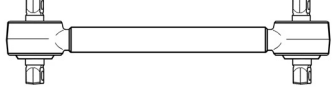
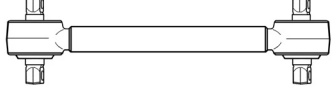
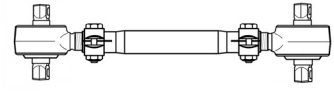

Originalni broj Cross-Ref.-No. Original Nr.	Br. FAD No. Nr.	Naziv Designation Bezeichnung	Kugla Ball Ø Größe	Konus Taper Konus	Duzina Length Länge	Skica Figure Bild
50 00 792 132	7474.20.00	Zglob,RH 24x1.5 * Ball joint, RH Kugelgelenk, RH	40	K30	95	
50 00 802 123	5755.96.00	Izmenljivi podsklop Repair kit Reparatur satz	70	Ø19 >30<	<145>	
50 00 807 553 50 00 814 096 50 01 844 135	5805.10.00	Zglob,LH M24x1.5 Ball joint, LH Kugelgelenk, LH	30	K20	95	
50 00 808 458 77 01 002 911	5742.20.00	Zglob,RH 30x1.5 Ball joint, RH Kugelgelenk, RH	40	K26	120	
50 00 814 841	3284.96.00	Izmenljivi podsklop Repair kit Reparatur satz	55	Ø15 >24<	<100>	
50 00 819 365 50 10 104 465	5992.96.00	Izmenljivi podsklop Repair kit Reparatur satz	62	Ø17 >24<	<122>	
50 01 014 520	5524.90.00	Izmenljivi podsklop Repair kit Reparatur satz	65	K38		
50 01 840 095	3637.96.00	Izmenljivi podsklop Repair kit Reparatur satz	85	K45		

Originalni broj Cross-Ref.-No. Original Nr.	Br. FAD No. Nr.	Naziv Designation Bezeichnung	Kugla Ball Ø Größe	Konus Taper Konus	Duzina Length Länge	Skica Figure Bild
50 01 842 823 50 10 104 465	5170.96.00	Izmenljivi podsklop Repair kit Reparatur satz	70	Ø19 >30<	<130>	
50 01 858 763	4681.20.00	Zglob,RH 30x1.5 Ball joint, RH Kugelgelenk, RH	40	K30	125	
50 01 860 359	4672.00.00	Spona upravljacka Drag link Lenkstange Izmenljivi delovi Parts list Stuckliste 5743.10.00 5743.20.00	40	K30	1690 RØ50	
50 10 005 937	3285.00.00	Vodjica mosta Torque rod Achsstrebe Izmenljivi delovi Parts list Stuckliste 5992.96.00	62	Ø17 >24< <122>	480 RØ50	
50 10 025 292	3284.00.00	Vodjica mosta Torque rod Achsstrebe Izmenljivi delovi Parts list Stuckliste 3284.96.00	55	Ø15 >24< <100>	500 RØ50	
50 10 037 602 50 10 037 603 50 10 130 456	3948.00.00	Spona upravljacka Drag link Lenkstange Izmenljivi delovi Parts list Stuckliste 5746.20.00	30	K22	902 RØ40	

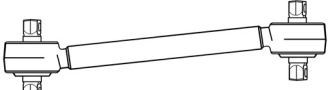
Originalni broj Cross-Ref.-No. Original Nr.	Br. FAD No. No.	Naziv Designation Bezeichnung	Kugla Ball Ø Größe	Konus Taper Konus	Duzina Length Länge	Skica Figure Bild
50 10 060 764 50 10 557 243	3297.00.00	Spona upravljacka Drag link Lenkstange Izmenljivi delovi Parts list Stuckliste 5743.20.00	40	K30	720 RØ36	
50 10 094 839	4690.00.00	Vodjica mosta Torque rod Achsstrebe Izmenljivi delovi Parts list Stuckliste 4690.90.00	80	Ø21 >35< <152>	575 RØ62	
50 10 094 840	3282.00.00	Vodjica mosta Torque rod Achsstrebe Izmenljivi delovi Parts list Stuckliste 3282.90.00	65	Ø21 >35< <152>	575 RØ50	
50 10 097 562	6359.00.00	Poprečna spona Tie rod Spurstange Izmenljivi delovi Parts list Stuckliste 5746.10.00 5746.20.00	30	K22	1404 RØ36	
50 10 098 467 50 10 145 584 50 10 439 631	4675.00.00	Poprečna spona Tie rod Spurstange Izmenljivi delovi Parts list Stucklist 5743.10.00 5743.20.00	40	K30	1745 RØ50	
50 10 130 344	3291.00.00	Spona upravljacka Drag link Lenkstange Izmenljivi delovi Parts list Stuckliste 5743.20.00	40	K30	745 RØ52	

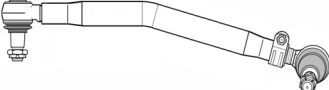
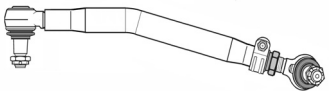
Originalni broj Cross-Ref.-No. Original Nr.	Br. FAD No. No. Nr.	Naziv Designation Bezeichnung	Kugla Ball Ø Größe	Konus Taper Konus	Duzina Length Länge	Skica Figure Bild
50 10 145 078	4674.00.00	Poprecna spona Tie rod Spurstange Izmenljivi delovi Parts list Stuckliste 5856.10.00 5856.20.00	40	K30	1616 RØ50	
50 10 197 399	3286.00.00	Vodjica mosta Torque rod Achsstrebe Izmenljivi delovi Parts list Stuckliste 5992.96.00	62	Ø17 >24< <122>	570 RØ50	
50 10 207 168	3287.00.00	Vodjica mosta Torque rod Achsstrebe Izmenljivi delovi Parts list Stuckliste 5992.96.00	62	Ø17 >24< <122>	550 RØ50	
50 10 207 726	3944.00.00	Vodjica mosta Torque rod Achsstrebe Izmenljivi delovi Parts list Stuckliste 5992.96.00	62	Ø17 >24< <122>	550 RØ50	
50 10 207 727	3945.00.00	Vodjica mosta Torque rod Achsstrebe Izmenljivi delovi Parts list Stuckliste 5992.96.00	62	Ø17 >24< <122>	692 RØ50	
50 10 207 771	3288.00.00	Vodjica mosta Torque rod Achsstrebe Izmenljivi delovi Parts list Stuckliste 5992.96.00	62	Ø17 >24< <122>	490 RØ50	

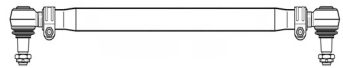
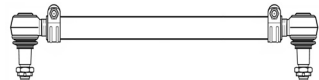
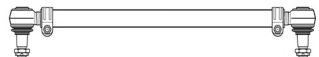
Originalni broj Cross-Ref.-No. Original Nr.	Br. FAD No. Nr.	Naziv Designation Bezeichnung	Kugla Ball Ø Größe	Konus Taper Konus	Duzina Length Länge	Skica Figure Bild
50 10 216 608	4677.00.00	Poprecna spona Tie rod Spurstange Izmenljivi delovi Parts list Stuckliste 5743.10.00 5743.20.00	40	K30	1516 RØ40	
50 10 268 035	5994.00.00	Vodjica mosta Torque rod Achsstrebe Izmenljivi delovi Parts list Stuckliste 5755.96.00	70	Ø19 >30< <145>	575 RØ50	
50 10 294 287	4670.00.00	Spona upravljacka Drag link Lenkstange Izmenljivi delovi Parts list Stuckliste 5743.20.00	40	K30	809 RØ50	
50 10 294 288	4668.00.00	Spona upravljacka Drag link Lenkstange Izmenljivi delovi Parts list Stuckliste 5743.20.00	40	K30	825 RØ52	
50 10 294 289	4669.00.00	Spona upravljacka Drag link Lenkstange Izmenljivi delovi Parts list Stuckliste 5743.20.00	40	K30	861 RØ60	

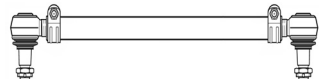

Originalni broj Cross-Ref.-No. Original Nr.	Br. FAD No. Nr.	Naziv Designation Bezeichnung	Kugla Ball Ø Größe	Konus Taper Konus	Duzina Length Länge	Skica Figure Bild
50 10 308 082 50 10 566 059	4676.00.00	Poprecna spona Tie rod Spurstange Izmenljivi delovi Parts list Stuckliste 5743.10.00 5743.20.00	40	K30	1720 RØ50	
50 10 308 214 50 10 439 984	4680.00.00	Poprecna spona Tie rod Spurstange Izmenljivi delovi Parts list Stuckliste 5741.10.00 5741.20.00	35	K26	1466 RØ36	
50 10 395 796 50 10 566 049	4678.00.00	Poprecna spona Tie rod Spurstange Izmenljivi delovi Parts list Stuckliste 5741.10.00 5741.20.00	35	K26	1500 RØ38	
50 10 439 021 50 10 566 063	4682.00.00	Poprecna spona Tie rod Spurstange Izmenljivi delovi Parts list Stuckliste 4681.20.00	40	K30	1758 RØ52	
50 10 566 058	7762.00.00	Poprecna spona Tie rod Spurstange Izmenljivi delovi Parts list Stuckliste 5743.10.00 5743.20.00	40	K30	1650 RØ40	

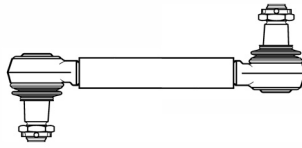
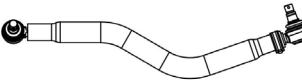
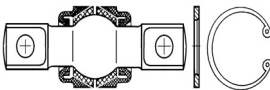

Originalni broj Cross-Ref.-No. Original Nr.	Br. FAD No. No.	Naziv Designation Bezeichnung	Kugla Ball Ø Größe	Konus Taper Konus	Duzina Length Länge	Skica Figure Bild
50 10 439 022	4681.00.00	Poprecna spona Tie rod Spurstange Izmenljivi delovi Parts list Stuckliste 4681.20.00	40	K30	1720 RØ52	
50 10 587 004 50 10 600 822	4683.00.00	Poprecna spona Tie rod Spurstange Izmenljivi delovi Parts list Stuckliste 6832.20.00	40	K30	1732 RØ60	
50 10 587 034 50 10 587 038	4685.00.00	Poprecna spona Tie rod Spurstange Izmenljivi delovi Parts list Stuckliste 6832.20.00	40	K30	1683 RØ60	
50 10 600 483	4686.00.00	Spona upravljacka Drag link Lenkstange Izmenljivi delovi Parts list Stuckliste 4686.20.00	40	K30	855 RØ60	
50 10 630 812 50 10 630 813	4687.00.00	Spona upravljacka Drag link Lenkstange Izmenljivi delovi Parts list Stuckliste 5743.20.00	40	K30	883 RØ60	
50 10 630 822 50 10 630 823	4684.00.00	Spona upravljacka Drag link Lenkstange Izmenljivi delovi Parts list Stuckliste 5743.20.00	40	K30	860 RØ60	

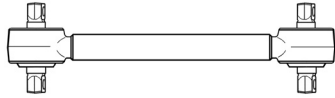
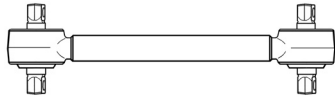
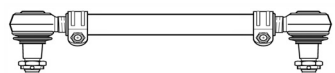
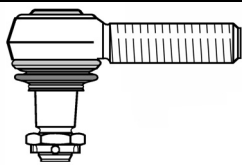
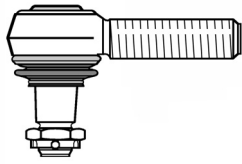
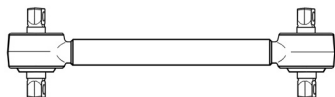
Originalni broj Cross-Ref.-No. Original Nr.	Br. FAD No. No. Nr.	Naziv Designation Bezeichnung	Kugla Ball Ø Größe	Konus Taper Konus	Duzina Length Länge	Skica Figure Bild
720 128	4667.00.00	Spona upravljača Drag link Lenkstange	35	K26	335 RØ36	
7420 761 145	4688.00.00	Spona upravljača Drag link Lenkstange Izmenljivi delovi Parts list Stuckliste 4668.20.00	40	K30	893 RØ60	
77 01 011 267	3698.90.00	Izmenljivi podsklop Repair kit Reparatur satz	65	Ø19 >30<	<130>	

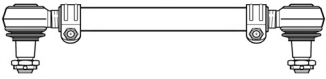
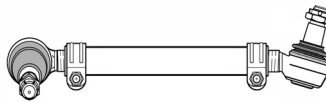
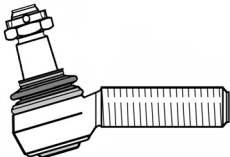
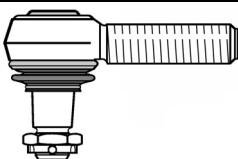
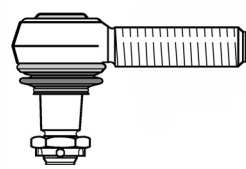

Originalni broj Cross-Ref.-No. Original Nr.	Br. FAD No. No. Nr.	Naziv Designation Bezeichnung	Kugla Ball Ø Größe	Konus Taper Konus	Duzina Length Länge	Skica Figure Bild
1 104 334 550 806 639 370	5323.96.00	Izmenljivi podsklop Repair kit Reparatur satz	62	Ø17 >24<	<115>	
1 104 335 639 287 638 862	5170.96.00	Izmenljivi podsklop Repair kit Reparatur satz	70	Ø19 >30<	<130>	
1 104 336	5587.96.00	Izmenljivi podsklop Repair kit Reparatur satz	78.5	Ø23 >35<	<152>	
114 406	5048.96.00	Izmenljivi podsklop Repair kit Reparatur satz	108	Ø36		
1 304 569	3087.00.00	Spona upravljacka Drag link Lenkstange Izmenljivi delovi Parts list Stuckliste 5743.20.00	40	K30	905 RØ50	
1 308 643	6839.00.00	Spona upravljacka Drag link Lenkstange	40	K30	1590 RØ40	

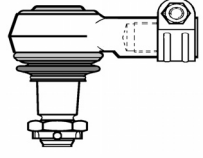
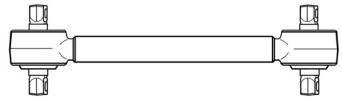
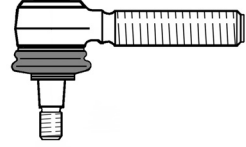
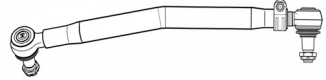
Originalni broj Cross-Ref.-No. Original Nr.	Br. FAD No. No. Nr.	Naziv Designation Bezeichnung	Kugla Ball Ø Größe	Konus Taper Konus	Duzina Length Länge	Skica Figure Bild
1 324 890	6842.00.00	Vodjica mosta Torque rod Achsstrebe Izmenljivi delovi Parts list Stuckliste 5323.96.00	62	Ø17 >24< <115>	697 RØ50	
1 326 775	3084.00.00	Vodjica mosta Torque rod Achsstrebe Izmenljivi delovi Parts list Stuckliste 5323.96.00	62	Ø17 >24< <115>	522 RØ50	
1 334 139	6830.00.00	Spona upravljacka Drag link Lenkstange Izmenljivi delovi Parts list Stuckliste 5743.10.00 5743.20.00	40	K30	786 RØ40	
1 337 366 352 645	5810.10.00	Zglob,LH M30x1.5 Ball joint, LH Kugelgelenk, LH	50	K30	135	
1 337 367 352 646	5810.20.00	Zglob,RH M30x1.5 Ball joint, RH Kugelgelenk, RH	50	K30	135	
1 338 769 1 428 347	3083.00.00	Vodjica mosta Torque rod Achsstrebe Izmenljivi delovi Parts list Stuckliste 5323.96.00	62	Ø17 >24< <115>	568 RØ50	

Originalni broj Cross-Ref.-No. Original Nr.	Br. FAD No. Nr.	Naziv Designation Bezeichnung	Kugla Ball Ø Größe	Konus Taper Konus	Duzina Length Länge	Skica Figure Bild
1 343 266 1 759 690	6835.00.00	Spona upravljača Drag link Lenkstange Izmenljivi delovi Parts list Stuckliste 5743.10.00 5743.20.00	40	K30	495 RØ40	
1 343 283 1 759 691	6838.00.00	Spona upravljača Drag link Lenkstange Izmenljivi delovi Parts list Stuckliste 5743.10.00 6832.20.00	40	K30	435 RØ40	
1 357 674	6832.20.00	Zglob,RH M30x1,5 Ball joint, RH Kugelgelenk, RH	40	K30	140	
1 358 793 1 738 381 283 783 395 009	5743.20.00	Zglob,LH M30x1.5 Ball joint, LH Kugelgelenk, LH	40	K30	120	
1 358 792 1 738 380 1 767 328 283 784 395 010	5743.10.00	Zglob,RH M30x1.5 Ball joint, RH Kugelgelenk, RH	40	K30	120	
1 361 413 1 395 614 1 734 019 1 897 333	6832.00.00	Poprečna spona Tie rod Spurstange Izmenljivi delovi Parts list Stuckliste 6832.20.00	40	K30	1743 RØ52	

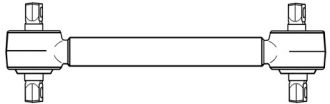
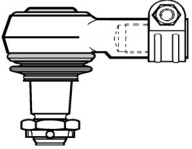
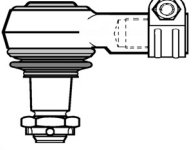
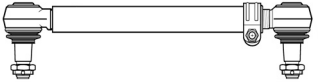
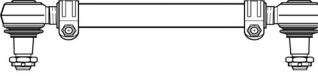
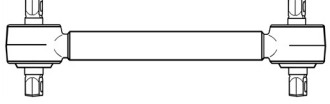
Originalni broj Cross-Ref.-No. Original Nr.	Br. FAD No. Nr.	Naziv Designation Bezeichnung	Kugla Ball Ø Größe	Konus Taper Konus	Duzina Length Länge	Skica Figure Bild
1 376 902	7523.20.00	Zglob,RH M24x1,5 * Ball joint, RH Kugelgelenk, RH	35	K26	90	
1 379 423	3343.00.00	Vodjica mosta Torque rod Achsstrebe Izmenljivi delovi Parts list Stuckliste 5323.96.00	62	Ø17 >24< <115>	752 RØ50	
1 383 405	3089.20.00	Zglob,RH 16x1.5 Ball joint, RH Kugelgelenk, RH	22	K12	85	
1 384 025 1 768 898	3082.00.00	Spona upravljacka Drag link Lenkstange Izmenljivi delovi Parts list Stuckliste 5743.20.00	40	K30	1055 RØ52	
1 384 027 1 769 597	6847.00.00	Spona upravljacka Drag link Lenkstange Izmenljivi delovi Parts list Stuckliste 5743.20.00	40	K30	1050 RØ52	
1 385 251 1 409 918 1 501 030 1 723 895 1 737 683 1 897 335	6833.00.00	Poprečna spona Tie rod Spurstange Izmenljivi delovi Parts list Stuckliste 5743.20.00	40	K30	1743 RØ50	

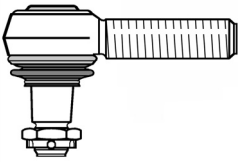
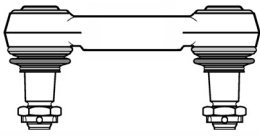
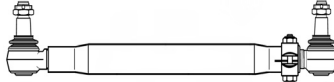
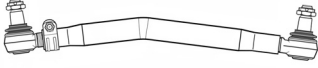
Originalni broj Cross-Ref.-No. Original Nr.	Br. FAD No. Nr.	Naziv Designation Bezeichnung	Kugla Ball Ø Größe	Konus Taper Konus	Duzina Length Länge	Skica Figure Bild
1 393 298	6841.00.00	Vodjica mosta Torque rod Achsstrebe Izmenljivi delovi Parts list Stuckliste 6409.96.00	55	Ø17 >24< <115>	752 RØ50	
1 394 443	7981.20.00	Zglob, RH 26x1.5 * Ball joint, RH Kugelgelenk, RH	40	K30	75	
1 394 444	7982.20.00	Zglob, RH 26x1.5 * Ball joint, RH Kugelgelenk, RH	40	K30	90	
1 394 884	6849.00.00	Poprecna spona Tie rod Spurstange Izmenljivi delovi Parts list Stuckliste 5743.20.00	40	K30	438 RØ40	
1 397 866 1 734 020 395 350	3126.00.00	Poprecna spona Tie rod Spurstange Izmenljivi delovi Parts list Stuckliste 5743.20.00 5743.10.00	40	K30	1736 RØ40	
1 399 180	6831.00.00	Vodjica mosta Torque rod Achsstrebe Izmenljivi delovi Parts list Stuckliste 5323.96.00	62	Ø17 >24< <115>	568 RØ50	

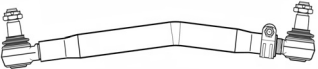

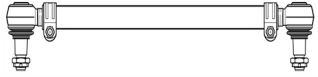
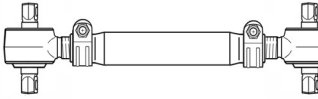
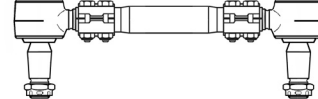
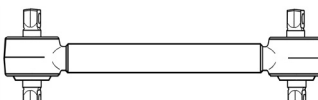
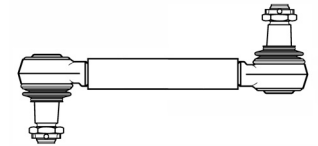
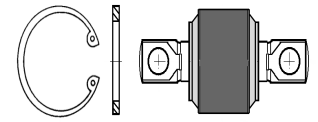

Originalni broj Cross-Ref.-No. Original Nr.	Br. FAD No. Nr.	Naziv Designation Bezeichnung	Kugla Ball Ø Größe	Konus Taper Konus	Duzina Length Länge	Skica Figure Bild
1 488 890 1 534 756	4126.20.00	Zglob, RH 30x1.5 Ball joint, RH Kugelgelenk, RH	40	K30	141	
1 766 015 445 626	6851.00.00	Stabilizator Stabilizer link Koppelstang	35	K26	130 RØ32	
1 897 673 475 463	6834.00.00	Spona upravljača Drag link Lenkstange Izmenljivi delovi Parts list Stuckliste 5743.20.00	40	K30	870 RØ50	
278 665	3148.00.00	Spona upravljača Drag link Lenkstange Izmenljivi delovi Parts list Stuckliste 5743.20.00	40	K30	940 RØ42	
291 396	6840.00.00	Spona upravljača Drag link Lenkstange Izmenljivi delovi Parts list Stuckliste 5743.20.00	40	K30	728 RØ40	
306 981	3149.00.00	Spona upravljača Drag link Lenkstange Izmenljivi delovi Parts list Stuckliste 5743.20.00	40	K30	940 RØ42	

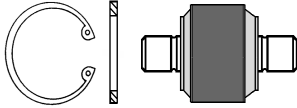
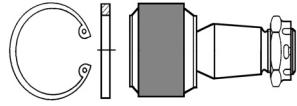
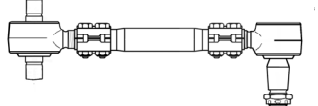
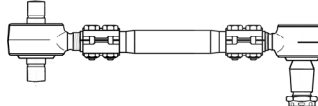
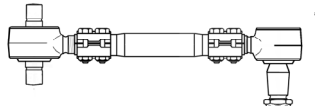

Originalni broj Cross-Ref.-No. Original Nr.	Br. FAD No. No. Nr.	Naziv Designation Bezeichnung	Kugla Ball Ø Größe	Konus Taper Konus	Duzina Length Länge	Skica Figure Bild
345 124	3348.00.00	Spona upravljacka Drag link Lenkstange Izmenljivi delovi Parts list Stuckliste 5743.20.00	40	K30	908 RØ50	
388 943	6836.00.00	Spona upravljacka Drag link Lenkstange Izmenljivi delovi Parts list Stuckliste 5743.10.00 5743.20.00	40	K30	611 RØ40	
390 784	3081.00.00	Spona upravljacka Drag link Lenkstange Izmenljivi delovi Parts list Stuckliste 5743.20.00	40	K30	850 RØ42	
409 639	3368.00.00	Vodjica mosta Torque rod Achsstrebe Izmenljivi delovi Parts list Stuckliste 5170.96.00 5847.96.00	70	Ø19 >30< K45	750 RØ50	
414 531	3138.00.00	Vodjica mosta Torque rod Achsstrebe Izmenljivi delovi Parts list Stuckliste 5170.96.00	70	Ø19 >30< <130>	750 RØ50	
417 290	3369.00.00	Vodjica mosta Torque rod Achsstrebe Izmenljivi delovi Parts list Stuckliste 5170.96.00	70	Ø19 >30<	635 RØ50	

Originalni broj Cross-Ref.-No. Original Nr.	Br. FAD No. Nr.	Naziv Designation Bezeichnung	Kugla Ball Ø Größe	Konus Taper Konus	Duzina Length Länge	Skica Figure Bild
421 573	6837.00.00	Spona upravljača Drag link Lenkstange Izmenljivi delovi Parts list Stuckliste 5743.10.00 5743.20.00	40	K30	1123 RØ40	
445 599 489 989	3361.00.00	Vodjica mosta Torque rod Achsstrebe Izmenljivi delovi Parts list Stuckliste 5170.96.00	70	Ø19 >30< <130>	650 RØ50	
445 629	6853.00.00	Vodjica mosta Torque rod Achsstrebe Izmenljivi delovi Parts list Stuckliste 5847.96.00	70	K45	725 RØ50	
465 816 466 801 489 987	3362.00.00	Vodjica mosta Torque rod Achsstrebe Izmenljivi delovi Parts list Stuckliste 5170.96.00	70	Ø19 >30< <130>	650 RØ50	
483 527	6844.00.00	Stabilizator Stabilizer link Koppelstang	35	K26	282 RØ36	
550 808	6409.96.00	Izmenljivi podsklop Repair kit Reparatur satz	55	Ø17 >24<	<115>	

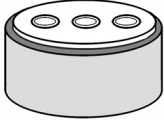

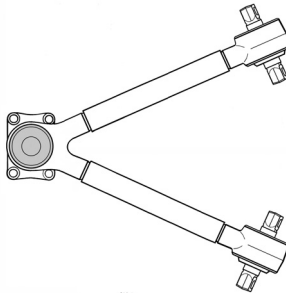
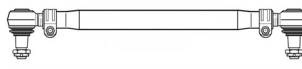
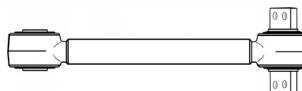

Originalni broj Cross-Ref.-No. Original Nr.	Br. FAD No. No.	Naziv Designation Bezeichnung	Kugla Ball Ø Größe	Konus Taper Konus	Duzina Length Länge	Skica Figure Bild
621 863	3363.00.00	Vodjica mosta Torque rod Achsstrebe Izmenljivi delovi Parts list Stuckliste 3363.96.00	70	>32<	990 RØ50	
638 860	3363.96.00	Izmenljivi podsklop Repair kit Reparatur satz	70	Ø32	166	
638 861	5847.96.00	Izmenljivi podsklop Repair kit Reparatur satz	85	K45	133	
649 346	3364.00.00	Vodjica mosta Torque rod Achsstrebe Izmenljivi delovi Parts list Stuckliste 3363.96.00 5847.96.00	70	K45 Ø32	803 RØ50	
651 156	3365.00.00	Vodjica mosta Torque rod Achsstrebe Izmenljivi delovi Parts list Stuckliste 3363.96.00 5847.96.00	70	K45 Ø32	725 RØ50	
651 157	3366.00.00	Vodjica mosta Torque rod Achsstrebe Izmenljivi delovi Parts list Stuckliste 3363.96.00 5847.96.00	70	K45 Ø32	803 RØ50	

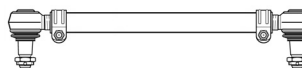
Originalni broj Cross-Ref.-No. Original Nr.	Br. FAD No. No. Nr.	Naziv Designation Bezeichnung	Kugla Ball Ø Größe	Konus Taper Konus	Duzina Length Länge	Skica Figure Bild
651 158	3367.00.00	Vodjica mosta Torque rod Achsstrebe Izmenljivi delovi Parts list Stuckliste 5847.96.00	70	K45	800 RØ50	

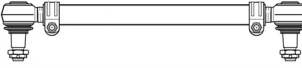
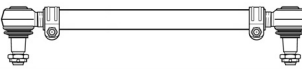
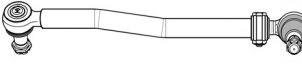
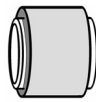
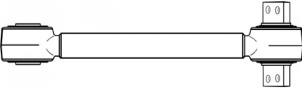

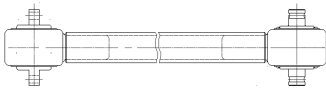

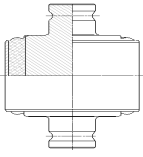
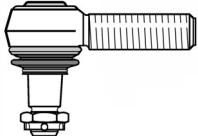
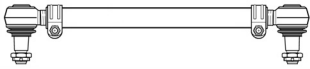
Originalni broj Cross-Ref.-No. Original Nr.	Br. FAD No. No. Nr.	Naziv Designation Bezeichnung	Kugla Ball Ø Größe	Konus Taper Konus	Duzina Length Länge	Skica Figure Bild
1 071 344 20 400 944 3 127 737	6264.00.00	Spona upravljacka Drag link Lenkstange Izmenljivi delovi Parts list Stuckliste 5741.20.00	35	K26	871 RØ52	
1 075 005	6725.00.00	Spona upravljacka Drag link Lenkstange Izmenljivi delovi Parts list Stuckliste 5596.20.00	35	K28.6	863 RØ52	
1 075 255 1 591 689 20 554 908 3 173 759	5580.90.00	Izmenljivi podslop Repair kit Reparatur satz	138	K87	96	
1 075 663 3 988 704	5141.00.00	Spona upravljacka Drag link Lenkstange Izmenljivi delovi Parts list Stuckliste 3546.20.00	40	K28.6	870 RØ52	
1 075 664 3 988 701	4224.00.00	Spona upravljacka Drag link Lenkstange Izmenljivi delovi Parts list Stuckliste 5596.20.00	35	K28.6	861 RØ52	

Originalni broj Cross-Ref.-No. Original Nr.	Br. FAD No. Nr.	Naziv Designation Bezeichnung	Kugla Ball Ø Größe	Konus Taper Konus	Duzina Length Länge	Skica Figure Bild
1 080 690 1 606 200	5587.00.00	V Vodjica mosta Torque rod Achsstrebe Izmenljivi delovi Parts list Stuckliste 5587.96.00 5943.90.00	80	Ø23 >35< <152> K46	636 RØ58	
1 080 792	6732.00.00	Poprecna spona Tie rod Spurstange Izmenljivi delovi Parts list Stuckliste 7720.10.00 7720.20.00	40	K31.5	1640 RØ50	
1 082 104	6758.00.00	Vodjica mosta Torque rod Achsstrebe Izmenljivi delovi Parts list Stuckliste 5581.90.00 5597.90.00	91	Ø14 >20< <125>	666 RØ58	
1 083 744	6729.00.00	Spona upravljacka Drag link Lenkstange Izmenljivi delovi Parts list Stuckliste 7720.20.00	40	K31.5	845 RØ42	
1 088 985 20 393 083	6768.00.00	Spona upravljacka Drag link Lenkstange Izmenljivi delovi Parts list Stuckliste 5596.10.00 5596.20.00	35	K28.6	572 RØ40	

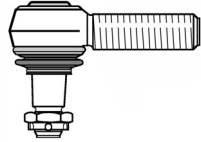
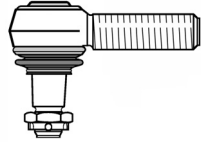
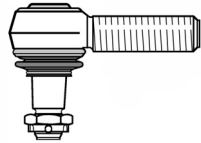
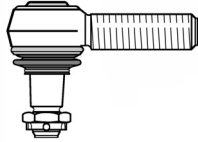
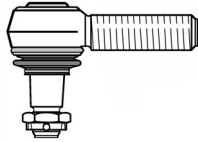
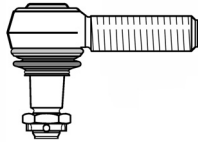
Originalni broj Cross-Ref.-No. Original Nr.	Br. FAD No. No.	Naziv Designation Bezeichnung	Kugla Ball Ø Größe	Konus Taper Konus	Duzina Length Länge	Skica Figure Bild
1 094 219	4216.00.00	Spona upravljacka Drag link Lenkstange Izmenljivi delovi Parts list Stuckliste 7720.20.00	40	K31.5	800 RØ60	
1 094 334 1 575 690	4219.00.00	Spona upravljacka Drag link Lenkstange Izmenljivi delovi Parts list Stuckliste 7720.10.00 7720.20.00	40	K31.5	750 RØ40	
1 130 567 1 612 781 1 614 838 85 114 197	6733.00.00	Spona upravljacka Drag link Lenkstange Izmenljivi delovi Parts list Stuckliste 7720.10.00 7720.20.00	40	K31.5	702 RØ42	
1 130 568	6765.00.00	Spona upravljacka Drag link Lenkstange Izmenljivi delovi Parts list Stuckliste 6765.20.00	40	K32	1095 RØ50	
1 134 955	5388.90.00	Izmenljivi podsklop Repair kit Reparatur satz	57.5	Ø28	55	
1 135 427	5599.00.00	Vodjica mosta Torque rod Achsstrebe Izmenljivi delovi Parts list Stuckliste 5597.90.00 5581.90.00	91	Ø14 >20< <125>	666 RØ58	

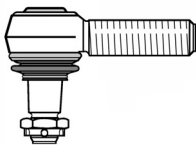
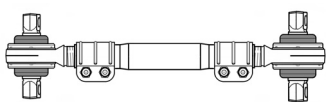
Originalni broj Cross-Ref.-No. Original Nr.	Br. FAD No. Nr.	Naziv Designation Bezeichnung	Kugla Ball Ø Größe	Konus Taper Konus	Duzina Length Länge	Skica Figure Bild
1 135 428	6751.00.00	Vodjica mosta Torque rod Achsstrebe Izmenljivi delovi Parts list Stuckliste 5581.90.00 6751.90.00	91	Ø14 >20< <125>	666 RØ58	
1 135 429 8 365 399	6756.00.00	Vodjica mosta Torque rod Achsstrebe Izmenljivi delovi Parts list Stuckliste 5597.90.00 5581.90.00	91	Ø14 >20< <125>	510 RØ58	
1 136 891	6751.90.00	Izmenljivi podsklop Repair kit Reparatur satz	91.4	Ø31.7	150	
1 190 778 1 517 449 1 518 142	5805.20.00	Zglob,RH M24x1,5 Ball joint, RH Kugelgelenk, RH	30	K20	95	
1 194 390	6753.00.00	Poprečna spona Tie rod Spurstange Izmenljivi delovi Parts list Stuckliste 7720.10.00 7720.20.00	40	K31.5	1674 RØ42	
1 197 338	5493.00.00	Spona upravljacka Drag link Lenkstange Izmenljivi delovi Parts list Stuckliste 5493.20.00	40	K31.5	1025 RØ60	





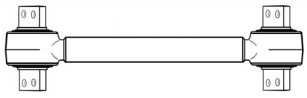
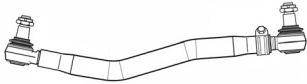
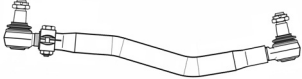
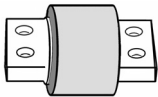
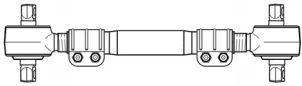
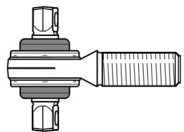
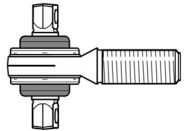

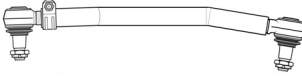
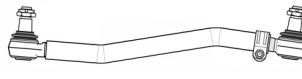
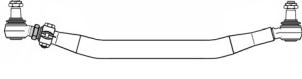
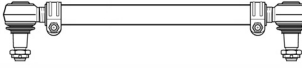
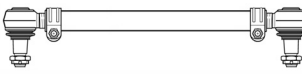
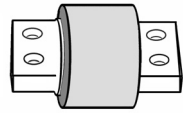
Originalni broj Cross-Ref.-No. Original Nr.	Br. FAD No. No.	Naziv Designation Bezeichnung	Kugla Ball Ø Größe	Konus Taper Konus	Duzina Length Länge	Skica Figure Bild
1 505 758 1 507 822 1 698 533 1 698 847	3546.10.00	Zglob,LH M30x1.5 Ball joint, LH Kugelgelenk, LH	40	K28.6	120	
1 505 759 1 507 823 1 698 532 1 698 846	3546.20.00	Zglob,RH 30x1.5 Ball joint, RH Kugelgelenk, RH	40	K28.6	120	
1 507 826 1 695 585 1 695 776 1 698 557	7720.20.00	Zglob,RH 30x1.5 Ball joint, RH Kugelgelenk, RH	40	K31.5	120	
1 517 439 1 698 190	5746.10.00	Zglob,LH 28x1.5 Ball joint, LH Kugelgelenk, LH	30	K22	105	
1 517 440 1 517 444 1 698 190	5746.20.00	Zglob,RH 28x1.5 Ball joint, RH Kugelgelenk, RH	30	K22	105	
1 517 448	5805.10.00	Zglob, LH 24x1.5 Ball joint, LH Kugelgelenk, LH	30	K20	95	

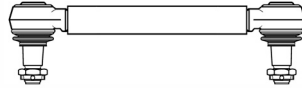
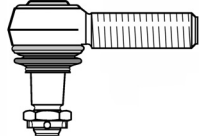
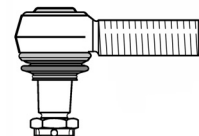
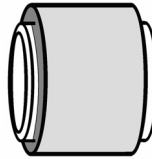
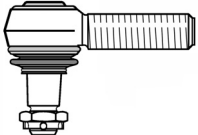
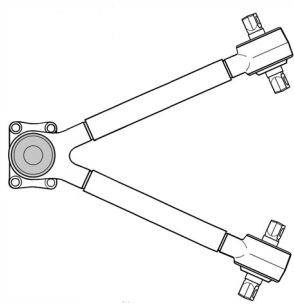
Originalni broj Cross-Ref.-No. Original Nr.	Br. FAD No. Nr.	Naziv Designation Bezeichnung	Kugla Ball Ø Größe	Konus Taper Konus	Duzina Length Länge	Skica Figure Bild
1 527 234 382 745	6762.20.00	Zglob, RH 28x1.5 Ball joint, RH Kugelgelenk, RH	25	K16	85	
1 573 572	6750.00.00	Vodjica mosta Torque rod Achsstrebe Izmenljivi delovi Parts list Stuckliste 6750.20.00 6750.10.00	53	Ø20 >24< <102>	357 RØ50	
1 576 092 1 606 283	3074.00.00	Spona upravljacka Drag link Lenkstange Izmenljivi delovi Parts list Stuckliste 7720.20.00	40	K31.5	885 RØ42	
1 576 093 1 606 284	7720.00.00	Spona upravljacka Drag link Lenkstange Izmenljivi delovi Parts list Stuckliste 7720.20.00	40	K31.5	870 RØ42	
1 581 527 1 607 079 8 154 017 8 158 206 8 158 207	5594.00.00	Vodjica mosta Torque rod Achsstrebe Izmenljivi delovi Parts list Stuckliste 5594.96.00	70	Ø21 >30< <130>	660 RØ50	
1 588 263 1 606 277 1 626 493	6734.00.00	Spona upravljacka Drag link Lenkstange Izmenljivi delovi Parts list Stuckliste 7720.20.00	40	K31.5	710 RØ42	

Originalni broj Cross-Ref.-No. Original Nr.	Br. FAD No. No.	Naziv Designation Bezeichnung	Kugla Ball Ø Größe	Konus Taper Konus	Duzina Length Länge	Skica Figure Bild
1 589 817	5584.00.00	Vodjica mosta Torque rod Achsstrebe Izmenljivi delovi Parts list Stuckliste 5581.90.00	91	Ø14 >20< <125>	666 RØ58	
1 592 939 85 114 144	3075.00.00	Spona upravljača Drag link Lenkstange Izmenljivi delovi Parts list Stuckliste 7720.20.00	40	K31.5	795 RØ50	
1 592 940 85 114 145	4223.00.00	Spona upravljača Drag link Lenkstange Izmenljivi delovi Parts list Stuckliste 7720.20.00	40	K31.5	800 RØ52	
1 598 588	5581.90.00	Izmenljivi podsklop Repair kit Reparatur satz	91	Ø14	<125>	
1 606 551 8 154 016	5598.00.00	Vodjica mosta Torque rod Achsstrebe Izmenljivi delovi Parts list Stuckliste 5581.96.00	62	Ø21 >24< <130>	660 RØ50	
1 608 351	6750.20.00	Zglob, RH 38x1.5 Ball joint, RH Kugelgelenk, RH	53	Ø20 >24<	150 <102>	
1 608 352	6750.10.00	Zglob, LH 38x1.5 Ball joint, LH Kugelgelenk, LH	53	Ø20 >24<	150 <102>	

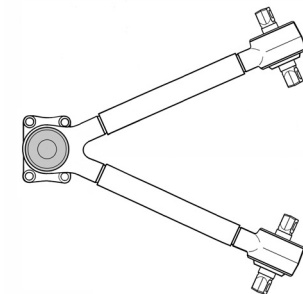
Originalni broj Cross-Ref.-No. Original Nr.	Br. FAD No. Nr.	Naziv Designation Bezeichnung	Kugla Ball Ø Größe	Konus Taper Konus	Duzina Length Länge	Skica Figure Bild
1 610 338 1 626 751	5595.00.00	Spona upravljača Drag link Lenkstange Izmenljivi delovi Parts list Stuckliste 7720.20.00	40	K31.5	850 RØ42	
1 611 880 1 626 670	4212.00.00	Spona upravljača Drag link Lenkstange Izmenljivi delovi Parts list Stuckliste 7720.20.00	40	K31.5	824 RØ42	
1 612 254 20 393 097 21 260 286 3 985 570	6746.00.00	Poprecna spona Tie rod Spurstange Izmenljivi delovi Parts list Stuckliste 4222.20.00	40	K28.6	1640 RØ60	
1 626 494	5136.00.00	Poprecna spona Tie rod Spurstange Izmenljivi delovi Parts list Stuckliste 3546.10.00 3546.20.00	40	K28.6	1592 RØ40	
1 626 637 3 962 343 3 988 711	6769.00.00	Poprecna spona Tie rod Spurstange Izmenljivi delovi Parts list Stuckliste 5596.10.00 5596.20.00	35	K28.6	1645 RØ42	
1 628 107	5586.90.00	Izmenljivi podsklop Repair kit Reparatur satz	91	Ø14	<145>	

Originalni broj Cross-Ref.-No. Original Nr.	Br. FAD No. No.	Naziv Designation Bezeichnung	Kugla Ball Ø Größe	Konus Taper Konus	Duzina Length Länge	Skica Figure Bild
1 628 636 85 114 200	5596.00.00	Spona upravljača Drag link Lenkstange Izmenljivi delovi Parts list Stuckliste 3546.20.00	40	K28.6	880 RØ52	
1 629 668 3 986 433	4225.00.00	Stabilizator Stabilizer link Koppelstang	30	K22	325 RØ30	
1 695 840	7720.10.00	Zglob,LH M30x1.5 Ball joint, LH Kugelgelenk, LH	40	K31.5	120	
1 697 246 1 698 047	4208.20.00	Zglob, RH 30x1.5 Ball joint, RH Kugelgelenk, RH	40	K30	120	
1 135 030	5597.90.00	Izmenljivi podslop Repair kit Reparatur satz	91.3	Ø52	74	
1 696 920	4746.20.00	Zglob,RH M24x1,5 Ball joint, RH Kugelgelenk, RH	30	K22	105	
20 367 004 20 507 262 20 741 695 20 741 703 7420 741 703	6720.00.00	V Vodjica mosta Torque rod Achsstrebe Izmenljivi delovi Parts list Stuckliste 5521.96.00	65/62	Ø19 >24< <115> K38	663 RØ50	

Originalni broj Cross-Ref.-No. Original Nr.	Br. FAD No. No.	Naziv Designation Bezeichnung	Kugla Ball Ø Größe	Konus Taper Konus	Duzina Length Länge	Skica Figure Bild
20 374 831 21 252 480	6267.00.00	Spona upravljacka Drag link Lenkstange Izmenljivi delovi Parts list Stuckliste 3546.20.00	40	K28.6	563 RØ50	
20 375 555 20 393 186 21 106 930 3 986 452	4221.00.00	Spona upravljacka Drag link Lenkstange Izmenljivi delovi Parts list Stuckliste 3546.20.00	40	K28.6	863 RØ52	
20 382 314 20 502 944	6721.00.00	V Vodjica mosta Torque rod Achsstrebe Izmenljivi delovi Parts list Stuckliste 6721.96.00	65/62	Ø19 >24< <115> K38	649 RØ50	
20 390 745 21 106 936	6726.00.00	Spona upravljacka Drag link Lenkstange Izmenljivi delovi Parts list Stuckliste 3546.20.00	40	K28.6	885 RØ50	
20 393 061 3 988 697	6747.00.00	Spona upravljacka Drag link Lenkstange Izmenljivi delovi Parts list Stuckliste 3546.20.00	40	K28.6	881 RØ52	
20 393 071 8 190 146	4220.00.00	Spona upravljacka Drag link Lenkstange Izmenljivi delovi Parts list Stuckliste 5596.20.00	35	K28.6	881 RØ52	

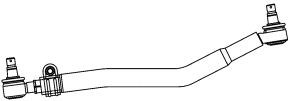
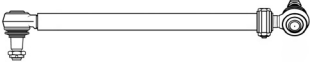
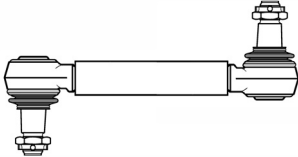
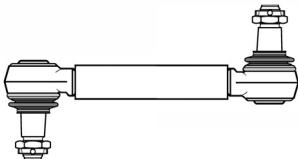
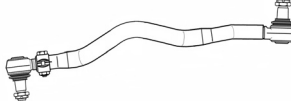
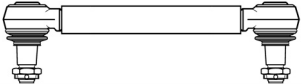
Originalni broj Cross-Ref.-No. Original Nr.	Br. FAD No. Nr.	Naziv Designation Bezeichnung	Kugla Ball Ø Größe	Konus Taper Konus	Duzina Length Länge	Skica Figure Bild
20 393 187 21 406 952	6268.00.00	Spona upravljača Drag link Lenkstange Izmenljivi delovi Parts list Stuckliste 4233.20.00	40	K28.6	863 RØ52	
20 400 909 3 124 480 3 124 594 6 777 855	4229.00.00	Spona upravljača Drag link Lenkstange Izmenljivi delovi Parts list Stuckliste 4746.20.00	30	K22	978 RØ30	
20 443 061 20 443 065 20 994 418	6266.00.00	Stabilizator Stabillizer link Koppelstang	40	K28.6	435 RØ36	
20 443 063 20 443 067 20 994 420	6262.00.00	Stabilizator Stabillizer link Koppelstang	40	K28.6	350 RØ36	
20 490 123 20 745 923 21 308 022 9 519 278	5494.00.00	Spona upravljača Drag link Lenkstange Izmenljivi delovi Parts list Stuckliste 5494.20.00	40	K28.8	1025 RØ60	
20 497 798 3 112 050 9 959 151	6261.00.00	Stabilizator Stabillizer link Koppelstang	40	K28.6	300 RØ30	

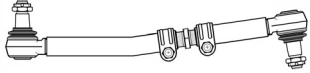
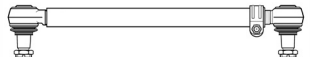
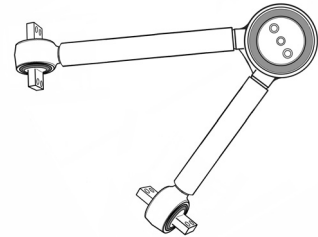
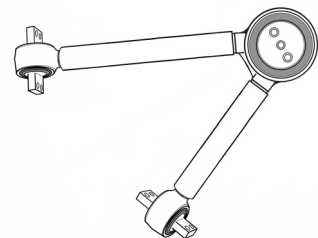
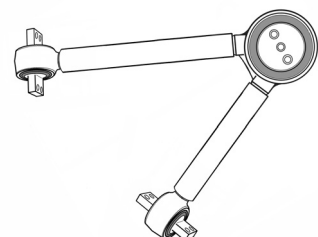

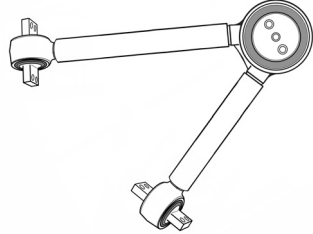
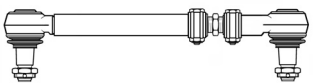
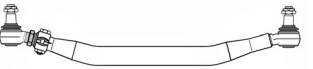
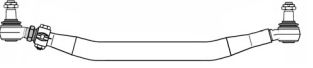
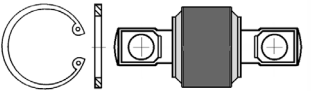
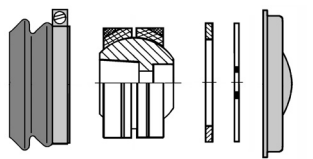
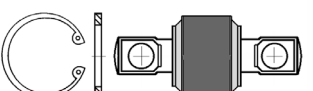

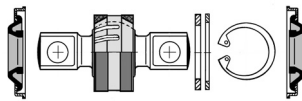
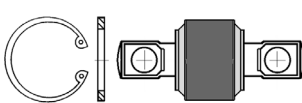
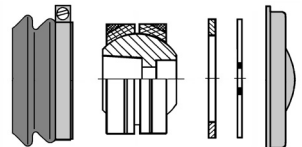
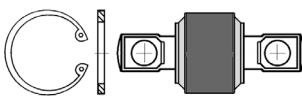
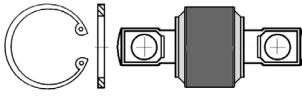
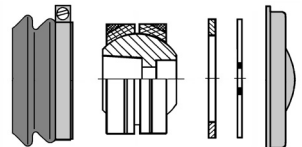
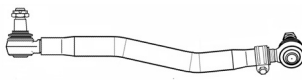
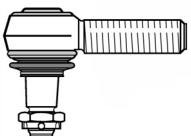
Originalni broj Cross-Ref.-No. Original Nr.	Br. FAD No. No.	Naziv Designation Bezeichnung	Kugla Ball Ø Größe	Konus Taper Konus	Duzina Length Länge	Skica Figure Bild
20 497 799 3 112 273 9 959 152	6263.00.00	Poprecna spona Tie rod Spurstange	40	K28.6	743 RØ40	
20 497 800 3 112 122 9 959 153	6731.00.00	Spona upravljac Drag link Lenkstange Izmenljivi delovi Parts list Stuckliste 5596.20.00	35	K28.6	763 RØ40	
20 556 490 3 173 291	6723.00.00	V Vodjica mosta Triangular torque rod Dreieckslenker Izmenljivi delovi Parts list Stuckliste 5580.90.00 5586.90.00	137/91	Ø15 >26< <145> K87	677 RØ58	
20 556 491 3 173 292	6761.00.00	V Vodjica mosta Triangular torque rod Dreieckslenker Izmenljivi delovi Parts list Stuckliste 5580.90.00 5586.90.00	137/91	Ø15 >26< <145> K87	680 RØ58	
20 556 492 3 173 293	6737.00.00	V Vodjica mosta Triangular torque rod Dreieckslenker Izmenljivi delovi Parts list Stuckliste 5580.90.00 5586.90.00	137/91	Ø15 >26< <145> K87	655 RØ58	

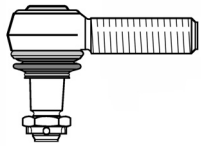
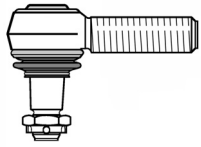
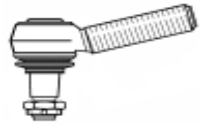
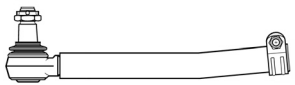
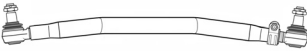
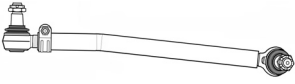
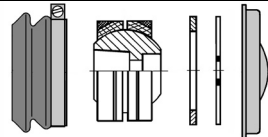
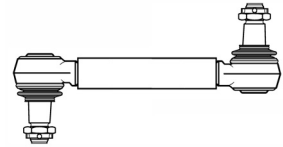
Originalni broj Cross-Ref.-No. Original Nr.	Br. FAD No. Nr.	Naziv Designation Bezeichnung	Kugla Ball Ø Größe	Konus Taper Konus	Duzina Length Länge	Skica Figure Bild
20 556 586 3 173 294	6738.00.00	V Vodjica mosta Triangular torque rod Dreieckslenker Izmenljivi delovi Parts list Stuckliste 5580.90.00 5586.90.00	137/91	Ø14 >20< <125> K87	685 RØ58	
20 739 082 70 311 664	6260.00.00	Spona upravljača Drag link Lenkstange	35	K28.6	1243 RØ40	
21 260 274 3 198 276	6727.00.00	Poprečna spona Tie rod Spurstange Izmenljivi delovi Parts list Stuckliste 4222.20.00	40	K28.6	1634 RØ50	
21 260 275 3 198 234	6728.00.00	Poprečna spona Tie rod Spurstange Izmenljivi delovi Parts list Stuckliste 4222.20.00	40	K28.6	1660 RØ60	
271 187	5323.96.00	Izmenljivi podsklop Repair kit Reparatur satz	62	Ø17 >24<	<115>	
271 188	5121.90.00	Izmenljivi podsklop Repair kit Reparatur satz	65	K38		
273 373 274 019 4 941 233	5594.96.00	Izmenljivi podsklop Repair kit Reparatur satz	70	Ø21 >30<	<130>	

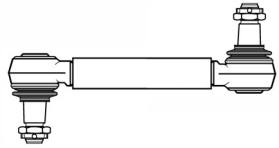
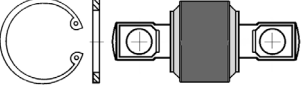
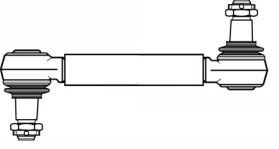
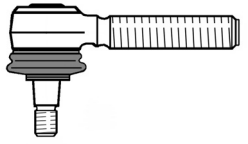
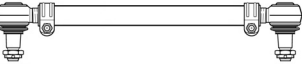
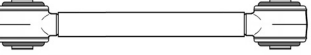
Originalni broj Cross-Ref.-No. Original Nr.	Br. FAD No. No.	Naziv Designation Bezeichnung	Kugla Ball Ø Größe	Konus Taper Konus	Duzina Length Länge	Skica Figure Bild
273 375	5945.90.00	Izmenljivi podsklop Repair kit Reparatur satz	80	Ø23 >35<	<152>	
273 612	5386.96.00	Izmenljivi podsklop Repair kit Reparatur satz	78.5	Ø21 >35<	<130>	
273 706	5943.90.00	Izmenljivi podsklop Repair kit Reparatur satz	80	K46		
274 056 276 192	5587.96.00	Izmenljivi podsklop Repair kit Reparatur satz	78.5	Ø23 >35<	<152>	
274 068	3744.96.00	Izmenljivi podsklop Repair kit Reparatur satz	70	Ø21 >24<	<152>	
274 069	5589.90.00	Izmenljivi podsklop Repair kit Reparatur satz	65	K42		
3 039 647	4211.00.00	Spona upravljača Drag link Lenkstange Izmenljivi delovi Parts list Stuckliste 5741.20.00	35	K26	1030 RØ42	
3 090 727 3 092 472 3 988 965	5596.20.00	Zglob,RH M30x1.5 Ball joint, RH Kugelgelenk, RH	35	K28.6	115	

Originalni broj Cross-Ref.-No. Original Nr.	Br. FAD No. Nr.	Naziv Designation Bezeichnung	Kugla Ball Ø Größe	Konus Taper Konus	Duzina Length Länge	Skica Figure Bild
3 090 728 3 110 001 3 988 968	5596.10.00	Zglob,LH M30x1.5 Ball joint, LH Kugelgelenk, LH	35	K28.6	115	
3 093 647	4233.20.00	Zglob,RH M30x1.5 Ball joint, RH Kugelgelenk, RH	40	K28.6	141	
3 097 228 3 099 529	4222.20.00	Zglob,RH M30x1,5 Ball joint, RH Kugelgelenk, RH	40	K28.6	140	
3 098 294 85 104 265	6748.00.00	Spona upravljacka Drag link Lenkstange	40	K28.6	495 RØ40	
3 116 050	4209.00.00	Poprecna spona Tie rod Spurstange Izmenljivi delovi Parts list Stuckliste 7720.20.00	40	K31.5	1820 RØ50	
3 124 964 6 799 190	4208.00.00	Spona upravljacka Drag link Lenkstange Izmenljivi delovi Parts list Stuckliste 4208.20.00	40	K30	885 RØ40	
3 133 173	5524.90.00	Izmenljivi podsklop Repair kit Reparatur satz	65	K38		
3 173 613 3 987 354	4218.00.00	Stabilizator Stabilizer link Koppelstang	40	K28.6	440 RØ36	

Originalni broj Cross-Ref.-No. Original Nr.	Br. FAD No. No.	Naziv Designation Bezeichnung	Kugla Ball Ø Größe	Konus Taper Konus	Duzina Length Länge	Skica Figure Bild
3 173 614	4232.00.00	Stabilizator Stabilizer link Koppelstang	40	K28.6	380 RØ36	
3 198 309	4490.96.00	Izmenljivi podsklop Repair kit Reparatur satz	90	Ø25 >24<	<152>	
3 962 843	4200.00.00	Stabilizator Stabilizer link Koppelstang	50	K38	325 RØ40	
6 027 074 6 853 913	3590.20.00	Zglob,RH M14x1,5 Ball joint, RH Kugelgelenk, RH	22	K12	85	
6 771 112	5140.00.00	Poprecna spona Tie rod Spurstange Izmenljivi delovi Parts list Stuckliste 5741.10.00 5741.20.00	35	K26	1582 RØ40	
6 777 705	4240.00.00	Vodjica mosta Torque rod Achsstrebe Izmenljivi delovi Parts list Stuckliste 5554.20.00	40	Ø20	510 RØ40	

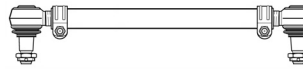
Originalni broj Cross-Ref.-No. Original Nr.	Br. FAD No. Nr.	Naziv Designation Bezeichnung	Kugla Ball Ø Größe	Konus Taper Konus	Duzina Length Länge	Skica Figure Bild
6 790 572	6739.00.00	Spona upravljacka Drag link Lenkstange Izmenljivi delovi Parts list Stuckliste 5741.20.00	35	K26	871 RØ42	
6 853 511	6767.00.00	Poprecna spona Tie rod Spurstange Izmenljivi delovi Parts list Stuckliste 5746.10.00 5746.20.00	30	K22	1407 RØ36	
8 132 373	4210.00.00	Spona upravljacka Drag link Lenkstange Izmenljivi delovi Parts list Stuckliste 7720.20.00	40	K31.5	1022 RØ60	
8 154 444	6730.00.00	Spona upravljacka Drag link Lenkstange Izmenljivi delovi Parts list Stuckliste 7720.20.00	40	K31.5	934 RØ50	
8 156 123	6754.00.00	Poprecna spona Tie rod Spurstange Izmenljivi delovi Parts list Stuckliste 5596.10.00 5596.20.00	35	K28.6	1674 RØ42	

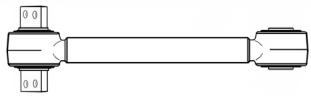
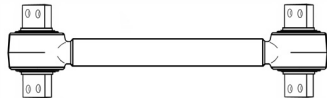
Originalni broj Cross-Ref.-No. Original Nr.	Br. FAD No. No.	Naziv Designation Bezeichnung	Kugla Ball Ø Größe	Konus Taper Konus	Duzina Length Länge	Skica Figure Bild
9 523 794	6759.00.00	Vodjica mosta Torque rod Achsstrebe Izmenljivi delovi Parts list Stuckliste 5581.90.00 5597.90.00	91	Ø14 >20< <125>	535 RØ60	
9 523 795	6755.00.00	Vodjica mosta Torque rod Achsstrebe Izmenljivi delovi Parts list Stuckliste 5581.90.00	91	Ø14 >20< <125>	535 RØ58	

**Pregled uporednih oznaka
Org. broj/FAD**

**The survey of parallel numbers
Org.nr./ FAD**

Originalni broj	FAD broj	Originalni broj	FAD broj	Originalni broj	FAD broj
0 067 354	5117.96.00	0 693 778	3755.90.00	1 353 391	6777.00.00
0 069 867	5742.20.00	0 693 778	3957.90.00	1 353 394	6780.00.00
0 080 521	3873.00.00	0 694 298	5741.20.00	1 361 155	6786.00.00
0 080 521	6770.00.00	0 694 360	5741.20.00	1 361 650	5398.00.00
0 094 016	5394.00.00	0 696 225	5743.10.00	1 361 652	3877.00.00
0 094 029	5393.00.00	0 696 226	5810.20.00	1 363 858	6787.00.00
0 094 038	5392.00.00	0 696 600	3875.90.00	1 368 270	6770.00.00
0 094 044	3889.00.00	0 698 450	5743.20.00	1 385 487	6794.00.00
0 099 990	5385.00.00	0 698 609	5741.20.00	1 385 490	6773.00.00
0 110 197	5746.20.00	0 698 724	3873.96.00	1 385 492	5389.00.00
0 117 343	5393.00.00	0 817 823	6297 20 00	1 385 493	6782.00.00
0 161 376	5742.20.00	0 817 824	7474.20.00	1 385 497	6784.00.00
0 171 215	5394.00.00	080 521	3873.00.00	1 385 499	3879.00.00
0 267 743	5398.00.00	099 900	5385.00.00	1 385 500	6793.00.00
0 273 203	3142.20.00	1 142 173	5742.20.00	1 385 506	6783.00.00
0 274 878	3889.00.00	1 143 324	6781.00.00	1 390 932	6770.00.00
0 513 757	5594.96.00	1 152 427	3889.00.00	1 395 994	6796.00.00
0 516 089	3965.20.00	1 191 900	6781.00.00	1 398 368	6770.90.00
0 525 433	5392.00.00	1 228 114	5746.20.00	1 398 368	6771.96.00
0 586 714	5810.20.00	1 228 115	5743.10.00	1 399 724	3142.20.00
0 586 753	5741.20.00	1 229 944	5741.20.00	1 448 062	6787.00.00
0 589 943	6795.00.00	1 243 618	6409.96.00	1 603 789	5743.20.00
0 607 053	5743.10.00	1 257 890	5743.20.00	1 617 096	6770.00.00
0 607 073	5810.20.00	1 257 991	6782.00.00	1 620 436	3877.00.00
0 607 451	5746.20.00	1 257 992	6773.00.00	1 620 437	3876.00.00
0 607 452	5746.10.00	1 261 101	5387.00.00	1 620 438	5399.00.00
0 607 453	5746.20.00	1 270 853	6777.00.00	1 656 428	5398.00.00
0 607 981	5743.20.00	1 271 124	5959.90.00	1 793 876	3877.00.00
0 607 998	5741.10.00	1 283 211	6784.00.00	1 793 877	3876.00.00
0 607 999	5741.20.00	1 283 212	5389.00.00	3 093 647	4233.20.00
0 608 000	5742.20.00	1 284 860	5399.00.00	696 321	5587.96.00
0 608 530	5805.20.00	1 290 321	6780.00.00	696 600	3875.90.00
0 609 634	5810.20.00	1 291 048	6793.00.00	698 724	3873.96.00
0 609 643	5810.20.00	1 291 060	3879.00.00	817 824	7474.20.00
0 646 373	5399.00.00	1 297 572	6786.00.00	94 029	5393.00.00
0 649 819	3876.00.00	1 306 333	6794.00.00	ACU 9239	6790.10.00
0 649 819	3876.00.00	1 315 530	6783.00.00	ACU 9240	6790.20.00
0 655 695	5399.00.00	1 320 855	3903.20.00		
0 655 697	5399.00.00	1 321 936	5128.96.00		
0 658 104	6772.00.00	1 331 925	5741.20.00		
0 658 104	6772.00.00	1 342 026	3903.20.00		
0 661 406	5386.00.00	1 344 684	6795.20.00		
0 661 407	5386.00.00	1 351 714	6784.00.00		
0 689 747	5847.96.00	1 351 715	5389.00.00		
0 689 748	5323.96.00	1 351 718	6782.00.00		
0 689 748	5521.96.00	1 351 731	6783.00.00		
0 689 749	5170.96.00	1 351 732	6773.00.00		
0 691 703	3744.96.00	1 351 734	3879.00.00		
0 691 704	5121.90.00	1 351 735	6793.00.00		
0 691 709	5594.96.00	1 351 741	6794.00.00		

Originalni broj	FAD broj
0598 660	5741.20.00
1124 113	7474.20.00
4125 657	5899.20.00
8408 188	7474.20.00
9970 7007 727	4303.20.00
9970 7016 595	4305.00.00
9970 7016 596	6100.00.00
9970 7016 597	4304.20.00
9970 7016 598	4311.20.00
9970 7016 599	4310.00.00
9970 7017 730	4315.00.00
9970 7060 050	4323.00.00
9970 7060 051	4244.00.00
9970 7731 304	4307.20.00
9970 7791 455	4314.00.00
9970 8408 376	3581.10.00
9970 8408 377	3581.20.00

Originalni broj	FAD broj	Originalni broj	FAD broj	Originalni broj	FAD broj
0813 7026	5120.00.00	4102 8599	3569.00.00	4248 3386	5743.20.00
0928 1792	7474.20.00	4102 8600	5120.00.00	4248 3520	5741.20.00
247 5843	6364.00.00	4103 4479	5120.00.00	4248 4886	5746.20.00
248 3652	5094.00.00	4103 6943	6418.00.00	4248 4887	5746.10.00
252 0334	5094.00.00	4104 2050	5120.00.00	4248 7165	4746.20.00
252 0336	5095.00.00	4104 2092	3569.00.00	4248 8269	5743.20.00
296 6252	5743.20.00	4120 3863	6432.20.00	4248 8722	5170.96.00
296 6321	5746.20.00	4121 4657	6415.00.00	4248 9395	5743.10.00
296 6635	5746.20.00	4129 8449	6430.00.00	4248 9573	5743.20.00
296 8454	5121.90.00	4200 0481	5104.00.00	4248 9594	5743.20.00
296 9507	5746.10.00	4200 0486	5097.00.00	4249 1638	5743.20.00
296 9808	5743.20.00	4200 1325	5118.00.00	4249 1937	5805.20.00
298 0129	5741.10.00	4200 1326	5118.00.00	4249 1957	5743.10.00
298 0323	5741.20.00	4200 3432	6403.00.00	4249 3431	3765.96.00
298 0875	5742.20.00	4201 4656	6364.00.00	4249 3781	5741.20.00
298 0884	5959.90.00	4201 9062	5108.00.00	4249 3782	5741.10.00
298 4061	5743.10.00	4202 6837	6364.00.00	4253 2543	5805.10.00
298 4511	5741.10.00	4202 6840	6364.00.00	4253 3101	6425.20.00
343 57 88	3567.20.00	4203 2936	5094.00.00	4253 3102	6425.20.00
343 5786	3590.20.00	4203 2938	5095.00.00	445 7748	3559.00.00
4 018 036	5391.20.00	4203 4051	5097.00.00	445 7748	5111.00.00
4 018 037	5391.10.00	4203 4054	5104.00.00	466 3787	3203.20.00
4 103 2608	6424.00.00	4203 7386	6359.00.00	468 8941	5122.20.00
4 103 3237	6424.00.00	4203 7655	6364.00.00	468 8948	5856.20.00
4 121 5165	5149.00.00	4203 7657	6364.00.00	468 8949	5856.10.00
4 121 5165	6423.00.00	4204 1107	5105.00.00	471 1108	5143.00.00
4 663 787	5391.20.00	4204 1327	6432.20.00	471 1109	5143.00.00
4 663 791	5391.10.00	4204 2431	5096.00.00	471 4134	5114.00.00
4100 2118	6432.20.00	4204 2912	3567.20.00	471 4134	5081.00.00
4100 2770	5120.00.00	4204 2950	5144.00.00	471 6271	5121.00.00
4100 5309	6405.00.00	4204 3912	5144.00.00	471 6799	5126.00.00
4100 5460	6405.00.00	4205 5474	5107.00.00	471 9609	5116.00.00
4100 5463	5119.00.00	4206 5332	5106.00.00	472 0262	6397.00.00
4100 5466	6398.00.00	4207 9853	6432.20.00	474 1171	6399.00.00
4100 5469	6414.00.00	4208 6458	5118.00.00	474 7960	5113.00.00
4100 5475	6422.00.00	4208 7842	5113.00.00	474 7961	5113.00.00
4100 6093	6422.00.00	4208 8124	6397.00.00	477 3359	5122.00.00
4100 9665	5120.00.00	4212 5057	5081.00.00	480 2443	5743.20.00
4101 1006	5106.00.00	4212 5057	5114.00.00	480 2444	5743.10.00
4101 1476	6414.00.00	4220 0700	3537.00.00	483 3821	5741.10.00
4101 6960	6414.00.00	4220 4475	3537.00.00	483 3825	5746.20.00
4101 6961	6414.00.00	4221 1146	3537.00.00	483 3826	5741.10.00
4101 6964	6398.00.00	4221 1148	3537.00.00	483 3826	5746.10.00
4102 8269	6430.00.00	4248 0023	5805.10.00	483 3828	5741.10.00
4102 8598	5120.00.00	4248 0024	5805.20.00	483 3829	5743.20.00

Originalni broj	FAD broj	Originalni broj	FAD broj
483 3830	5743.10.00	8601 2923	6359.00.00
483 4037	5122.00.00	8602 7074	3590.20.00
485 4871	6404.00.00	928 1792	7474.20.00
485 4874	5123.00.00	928 1792	7474.20.00
486 8942	5122.10.00	9316 1631	5120.90.00
500 307 556	6402.00.00	9316 1638	5120.90.00
500 324 282	6429.00.00	9316 3617	5128.96.00
500 333 284	4569.96.00	9319 1941	3559.00.00
5003 360 85	6433.00.00	9319 1941	5111.00.00
5003 977 38	4671.00.00	9319 2361	5117.96.00
6159 5957	5391.90.00	9319 2618	3744.96.00
716 7757	5122.20.00	9319 2619	3765.96.00
798 1909	3590.20.00	9319 2809	6426.20.00
8 601 1651	6363.00.00	9319 4626	4746.20.00
812 2752	5743.20.00	9380 0662	1480.20.00
812 2755	5741.10.00	9380 0662	3228.20.00
812 3394	5746.10.00	9380 2209	1481.20.00
813 1582	5119.00.00	9380 4059	3228.20.00
813 2397	5119.00.00	9380 4059	1480.20.00
813 5492	6414.00.00	9380 4060	1481.20.00
816 5309	6405.00.00	9710 4299	6341.00.00
819 0225	5743.10.00	9840 2544	5124.00.00
819 3645	5746.20.00	9840 2553	6402.00.00
819 3649	5805.10.00	9844 6354	5146.00.00
855 8522	5142.00.00	9844 9025	6417.00.00
855 8527	4746.20.00	9846 7459	5124.00.00
855 8533	5746.20.00	9846 9650	6417.00.00
855 8536	5746.10.00	9847 0968	6383.00.00
855 9559	3212.00.00	9847 2466	6342.00.00
856 4248	5147.00.00	9847 2468	3569.00.00
856 4386	3213.00.00	9847 2871	5117.00.00
856 5366	3393.00.00	9847 3328	6420.00.00
856 5366	5122.20.00	9847 5709	6427.00.00
856 7618	5145.00.00	9848 4091	6395.00.00
857 0528	3388.00.00	9848 8010	5103.00.00
857 0528	5148.00.00	9848 8010	5114.00.00
858 2320	3213.00.00	9849 3054	6428.00.00
858 2322	5746.20.00	9944 4744	6344.00.00
858 2330	3393.00.00	928 1792	7474.20.00
858 2332	5122.20.00		
858 2333	5122.10.00		
858 2350	5145.00.00		
858 7018	5087.00.00		
859 1219	5147.00.00		
859 1222	3212.00.00		

KÄSSBOHRER/FAD



Originalni broj	FAD broj	Originalni broj	FAD broj
6.293.500.606	6197.00.00	8.226.244.000 D	3492.00.00
6.851.446.000	5742.10.00	8.226.247.000 C	6049.00.00
6.851.447.000	5742.20.00	8.226.248.000 C	4911.00.00
6.851.459.000	5742.10.00	8.226.258.000 C	3492.00.00
6.851.475.000	5743.20.00	8.226.259.000 C	3494.00.00
6.851.478.000	5742.20.00	8.226.261.000 C	6043.00.00
6.851.479.000	5742.10.00	8.226.262.000 C	3494.00.00
6.851.480.000	5743.20.00	8.226.293.000B	6197.00.00
6.851.484.000	5743.20.00	8.226.305.000 C	3493.00.00
6.851.485.000	5743.10.00	8.226.308.000 C	4911.00.00
6.851.486.000	5742.20.00	8.226.313.000 C	3493.00.00
6.851.487.000	5742.10.00	8.226.318.000 B	3497.00.00
6.851.488.000	5742.20.00	8.226.323.000 B	3497.00.00
6.851.490.000	3581.10.00	8.226.380.000 C	4914.00.00
6.851.491.000	3581.20.00	8.226.380.000.0	4914.00.00
6.851.517.000	5741.20.00	82 262 320 660	5170.96.00
6.851.523.000	5742.20.00		
6.851.531.000	5743.20.00		
6.851.532.000	5742.10.00		
8.226.137.000	3493.00.00		
8.226.138.000	5687.00.00		
8.226.232.000	3491.00.00		
8.226.236.058	5743.10.00		
8.226.236.059	5743.20.00		
8.226.241.000	3491.00.00		
8.226.257.000	6042.00.00		
8.226.259.000	3494.00.00		
8.226.262.000	3494.00.00		
8.226.294.000	6044.00.00		
8.226.306.000	3492.00.00		
8.226.307.000	6049.00.00		
8.226.308.000	4911.00.00		
8.226.328.000	4912.00.00		
8.226.330.000	4915.00.00		
8.226.347.000	6049.00.00		
8.226.356.000	4913.00.00		
8.226.357.000	3491.00.00		
8.226.380.000	4914.00.00		
8.226.381.000	4911.00.00		
8.321.999.319	3590.20.00		
68.515.290.000	4911.20.00		
8.226.147.000 C	3493.00.00		
8.226.148.000 C	5687.00.00		
8.226.225.000 D	6045.00.00		
8.226.238.000 C	6048.00.00		

Originalni broj	FAD broj
10220897	3903.20.00
5211 434	6105.00.00
5211 434 08	6105.00.00
5211 435 08	6027.00.00
5211 438	6106.00.00
5211 438 08	6106.00.00
5211 439	6100.00.00
5211 440 08	6101.00.00
5211 441	6102.00.00
5211 441 08	6102.00.00
5211 448	6103.00.00
5211 448 08	6103.00.00
5211 543	4484.96.00
5211 543 08	4484.96.00
5708 158 08	6106.20.00
5708 159 08	6106.10.00
5708 160 08	6027.20.00
5708 161 08	6027.10.00
5708 196 08	6104.20.00
5708 197 08	6104.10.00
5718 665 08	5743.10.00
5718 666 08	5743.20.00
7250 510	7474.20.00
7250 510 08	7474.20.00

Originalni broj	FAD broj	Originalni broj	FAD broj	Originalni broj	FAD broj
81.43220.6010	5910.00.00	81.43220.6129	5546.00.00	81.43250.6007	5554.00.00
81.43220.6012	5910.00.00	81.43220.6129	5921.00.00	81.43250.6011	4137.00.00
81.43220.6013	5910.00.00	81.43220.6129	5937.00.00	81.43250.6014	4130.00.00
81.43220.6020	5910.00.00	81.43220.6129	5941.00.00	81.43250.6016	4137.00.00
81.43220.6025	5948.00.00	81.43220.6129	5959.00.00	81.43270.6030	5943.00.00
81.43220.6028	5910.00.00	81.43220.6129	6181.00.00	81.43270.6034	5943.00.00
81.43220.6035	5910.00.00	81.43220.6140	6186.00.00	81.43270.6040	3765.96.00
81.43220.6040	5910.00.00	81.43220.6148	5538.00.00	81.43270.6045	3765.96.00
81.43220.6041	5910.00.00	81.43220.6152	5538.00.00	81.43270.6047	3500.90.00
81.43220.6042	5951.00.00	81.43220.6161	4108.00.00	81.43270.6056	5944.00.00
81.43220.6043	5952.00.00	81.43220.6168	5339.00.00	81.43270.6057	5943.00.00
81.43220.6052	5910.00.00	81.43220.6174	6191.00.00	81.43270.6064	5323.96.00
81.43220.6053	5531.96.00	81.43220.6186	5538.00.00	81.43270.6065	5524.90.00
81.43220.6055	5170.96.00	81.43220.6189	4107.00.00	81.43270.6067	5944.00.00
81.43220.6056	5910.00.00	81.43220.6190	4108.00.00	81.43270.6074	5943.00.00
81.43220.6067	5950.00.00	81.43220.6203	5594.96.00	81.43270.6075	5944.00.00
81.43220.6068	5950.00.00	81.43220.6236	6188.00.00	81.43270.6076	5943.00.00
81.43220.6070	5938.00.00	81.43220.6247	6201.00.00	81.43270.6077	5944.00.00
81.43220.6071	5938.00.00	81.43220.6267	6188.00.00	81.43270.6078	5943.00.00
81.43220.6072	5938.00.00	81.43220.6272	6188.00.00	81.43270.6079	5587.96.00
81.43220.6073	5170.96.00	81.43220.9092	5950.00.00	81.43270.6081	5944.00.00
81.43220.6090	5950.00.00	81.43220.9140	6186.00.00	81.43270.6082	5943.00.00
81.43220.6091	5938.00.00	81.43230.6014	5546.00.00	81.43270.6096	6189.00.00
81.43220.6092	5950.00.00	81.43230.6014	5921.00.00	81.43270.6105	4492.96.00
81.43220.6093	5938.00.00	81.43230.6014	5937.00.00	81.43270.6105	5944.96.00
81.43220.6096	5546.00.00	81.43230.6014	5941.00.00	81.43270.6117	6219.00.00
81.43220.6096	5921.00.00	81.43230.6014	5959.00.00	81.43270.9034	5943.00.00
81.43220.6096	5937.00.00	81.43230.6015	5940.00.00	81.43270.9056	5944.00.00
81.43220.6096	5941.00.00	81.43230.6018	5910.00.00	81.43270.9078	5943.00.00
81.43220.6096	5959.00.00	81.43230.6030	5546.00.00	81.43315.6012	5535.00.00
81.43220.6097	5546.00.00	81.43230.6030	5921.00.00	81.43718.6006	5522.00.00
81.43220.6097	5921.00.00	81.43230.6030	5937.00.00	81.43718.6007	5522.00.00
81.43220.6097	5937.00.00	81.43230.6030	5941.00.00	81.43718.6009	5522.96.00
81.43220.6097	5941.00.00	81.43230.6030	5959.00.00	81.46610.6088	5520.00.00
81.43220.6097	5959.00.00	81.43230.6031	5940.00.00	81.46610.6089	5539.00.00
81.43220.6098	5546.00.00	81.43230.6037	3698.00.00	81.46610.6129	5335.00.00
81.43220.6098	5921.00.00	81.43230.6037	5537.00.00	81.46610.6147	5946.00.00
81.43220.6098	5937.00.00	81.43230.6038	5922.00.00	81.46610.6159	5219.00.00
81.43220.6098	5941.00.00	81.43230.6039	5922.00.00	81.46610.6195	5946.00.00
81.43220.6098	5959.00.00	81.43230.6043	3698.90.00	81.46610.6196	5932.00.00
81.43220.6099	5956.00.00	81.43230.6049	6173.00.00	81.46610.6200	5219.00.00
81.43220.6100	5956.00.00	81.43230.6051	5323.96.00	81.46610.6201	5946.00.00
81.43220.6102	5538.00.00	81.43230.6061	5117.96.00	81.46610.6202	5932.00.00
81.43220.6106	6173.00.00	81.43230.6068	5323.96.00	81.46610.6257	5946.00.00
81.43220.6108	5959.90.00	81.43230.9031	5940.00.00	81.46610.6281	4152.00.00

Originalni broj	FAD broj	Originalni broj	FAD broj	Originalni broj	FAD broj
81.46610.6300	4152.00.00	81.46610.6756	6211.00.00	81.46710.6240	5245.00.00
81.46610.6303	4152.00.00	81.46610.6767	7685.00.00	81.46710.6242	3777.00.00
81.46610.6304	4152.00.00	81.46610.6768	7685.00.00	81.46710.6251	3777.00.00
81.46610.6327	4152.00.00	81.46610.6779	6212.00.00	81.46710.6251	3777.00.00
81.46610.6329	4152.00.00	81.46610.6780	6212.00.00	81.46710.6265	5564.00.00
81.46610.6360	5536.00.00	81.46610.6782	6212.00.00	81.46710.6266	5564.00.00
81.46610.6361	5536.00.00	81.46610.6790	4136.00.00	81.46710.6267	5210.00.00
81.46610.6374	5975.00.00	81.46610.6791	4136.00.00	81.46710.6268	5210.00.00
81.46610.6376	6206.00.00	81.46610.6798	4145.00.00	81.46710.6281	4104.00.00
81.46610.6409	5932.00.00	81.46610.6876	4145.00.00	81.46710.6282	4104.00.00
81.46610.6414	5532.00.00	81.46611.6004	6224.00.00	81.46710.6294	5934.00.00
81.46610.6415	5946.00.00	81.46611.6005	6224.00.00	81.46710.6295	5933.00.00
81.46610.6424	5235.00.00	81.46611.6005	6224.00.00	81.46710.6302	6179.00.00
81.46610.6432	5235.00.00	81.46611.6006	5259.00.00	81.46710.6319	5219.00.00
81.46610.6434	5235.00.00	81.46611.6014	7685.00.00	81.46710.6337	5933.00.00
81.46610.6437	5235.00.00	81.46611.6019	5975.00.00	81.46710.6340	3776.00.00
81.46610.6476	5946.00.00	81.46611.6064	5219.00.00	81.46710.6344	3776.00.00
81.46610.6503	5946.00.00	81.46611.6067	6198.00.00	81.46710.6345	5933.00.00
81.46610.6504	5932.00.00	81.46611.6068	6202.00.00	81.46710.6353	5216.00.00
81.46610.6513	5235.00.00	81.46611.6096	6196.00.00	81.46710.6354	5216.00.00
81.46610.6531	5932.00.00	81.46611.6133	6223.00.00	81.46710.6355	5210.00.00
81.46610.6532	5946.00.00	81.46611.6133	6233.00.00	81.46710.6356	5210.00.00
81.46610.6537	5235.00.00	81.46611.6197	6216.00.00	81.46710.6359	5564.00.00
81.46610.6578	4145.00.00	81.46611.6198	6216.00.00	81.46710.6360	5564.00.00
81.46610.6593	5932.00.00	81.46611.6199	4131.00.00	81.46710.6361	5216.00.00
81.46610.6594	5946.00.00	81.46611.6200	4131.00.00	81.46710.6362	5564.00.00
81.46610.6596	5235.00.00	81.46710.6037	6179.00.00	81.46710.6370	4104.00.00
81.46610.6608	5946.00.00	81.46710.6054	6179.00.00	81.46710.6371	4104.00.00
81.46610.6609	5932.00.00	81.46710.6059	6179.00.00	81.46710.6372	4104.00.00
81.46610.6614	5235.00.00	81.46710.6080	5933.00.00	81.46710.6373	5210.00.00
81.46610.6630	5946.00.00	81.46710.6081	5934.00.00	81.46710.6378	4134.00.00
81.46610.6631	5932.00.00	81.46710.6112	5216.00.00	81.46710.6379	4134.00.00
81.46610.6635	5235.00.00	81.46710.6117	4104.00.00	81.46710.6380	4134.00.00
81.46610.6643	6221.00.00	81.46710.6122	4134.00.00	81.46710.6388	5215.00.00
81.46610.6656	5259.00.00	81.46710.6131	5564.00.00	81.46710.6393	5215.00.00
81.46610.6659	5259.00.00	81.46710.6136	5933.00.00	81.46710.6396	5564.00.00
81.46610.6689	6203.00.00	81.46710.6137	5934.00.00	81.46710.6397	5564.00.00
81.46610.6708	6198.00.00	81.46710.6145	6179.00.00	81.46710.6409	5245.00.00
81.46610.6716	6202.00.00	81.46710.6163	5216.00.00	81.46710.6410	5245.00.00
81.46610.6720	6203.00.00	81.46710.6165	5216.00.00	81.46710.6418	6222.00.00
81.46610.6721	5536.00.00	81.46710.6167	4134.00.00	81.46710.6419	5934.00.00
81.46610.6721	5536.00.00	81.46710.6172	5933.00.00	81.46710.6420	3777.00.00
81.46610.6722	5536.00.00	81.46710.6173	5934.00.00	81.46710.6421	5933.00.00
81.46610.6723	5536.00.00	81.46710.6175	3777.00.00	81.46710.6422	3776.00.00
81.46610.6725	4115.00.00	81.46710.6176	3776.00.00	81.46710.6434	5333.00.00
81.46610.6735	5235.00.00	81.46710.6194	4134.00.00	81.46710.6435	5333.00.00
81.46610.6740	5932.00.00	81.46710.6195	4134.00.00	81.46710.6436	6213.00.00
81.46610.6743	5235.00.00	81.46710.6198	5216.00.00	81.46710.6438	6214.00.00
81.46610.6753	4116.00.00	81.46710.6236	5210.00.00	81.46710.6439	6214.00.00
81.46610.6754	4116.00.00	81.46710.6238	5245.00.00	81.46710.6443	6207.00.00

Originalni broj	FAD broj	Originalni broj	FAD broj	Originalni broj	FAD broj
81.46710.6444	5934.00.00	81.46711.6765	4123.00.00	81.95301.6112	5743.20.00
81.46710.6451	5933.00.00	81.46711.6766	4123.00.00	81.95301.6126	5743.20.00
81.46710.6453	4123.00.00	81.46711.6767	4123.00.00	81.95301.6132	5943.90.00
81.46710.6456	5333.00.00	81.46711.6773	6218.00.00	81.95301.6133	5945.90.00
81.46710.6457	4123.00.00	81.46711.6786	6792.00.00	81.95301.6134	5805.20.00
81.46710.6458	4123.00.00	81.46711.6802	4148.00.00	81.95301.6135	5746.20.00
81.46710.6459	5976.00.00	81.46711.6804	4148.00.00	81.95301.6139	5746.10.00
81.46710.6459	5977.00.00	81.46711.6808	4148.00.00	81.95301.6140	5746.20.00
81.46710.6816	5564.00.00	81.46711.6820	5216.00.00	81.95301.6141	5805.10.00
81.46710.6818	5976.00.00	81.46711.6823	6791.00.00	81.95301.6142	5805.20.00
81.46710.6830	4134.00.00	81.46711.6858	6218.00.00	81.95301.6143	5743.20.00
81.46710.6836	4134.00.00	81.46711.6860	4135.00.00	81.95301.6149	5743.20.00
81.46710.6851	4119.00.00	81.46711.6861	4135.00.00	81.95301.6154	5743.20.00
81.46710.6852	4119.00.00	81.46711.6891	4148.00.00	81.95301.6155	5743.10.00
81.46710.6862	6792.00.00	81.46711.6892	4148.00.00	81.95301.6156	5743.20.00
81.46710.6863	6792.00.00	81.46711.6895	4148.00.00	81.95301.6163	5741.10.00
81.46710.6864	6792.00.00	81.46711.6921	4135.00.00	81.95301.6168	5743.10.00
81.46710.6865	5332.00.00	81.95301.0013	5741.10.00	81.95301.6169	3590.20.00
81.46710.6866	5332.00.00	81.95301.0015	5743.10.00	81.95301.6172	3590.20.00
81.46710.6875	4123.00.00	81.95301.0016	5743.20.00	81.95301.6176	3590.20.00
81.46710.6876	5933.00.00	81.95301.0022	3581.20.00	81.95301.6178	5743.20.00
81.46710.6877	5934.00.00	81.95301.0022	5810.20.00	81.95301.6179	5743.10.00
81.46710.6879	5934.00.00	81.95301.0025	5742.20.00	81.95301.6184	5856.20.00
81.46710.6881	4123.00.00	81.95301.0038	3590.20.00	81.95301.6194	5743.20.00
81.46710.6904	5564.00.00	81.95301.0040	5336.20.00	81.95301.6219	4109.20.00
81.46710.6908	5976.00.00	81.95301.0041	5337.20.00	81.95301.6219	6425.20.00
81.46710.6909	6792.00.00	81.95301.0045	3590.20.00	81.95301.6222	5746.10.00
81.46710.6910	6792.00.00	81.95301.0074	5741.10.00	81.95301.6224	5743.20.00
81.46710.6912	4134.00.00	81.95301.0077	5805.20.00	81.95301.6225	4109.20.00
81.46710.6918	4094.00.00	81.95301.0078	5805.10.00	81.95301.6225	6425.20.00
81.46710.6966	4133.00.00	81.95301.0079	5746.10.00	81.95301.6226	4109.20.00
81.46710.6974	6792.00.00	81.95301.0083	5743.10.00	81.95301.6226	6425.20.00
81.46710.6994	6215.00.00	81.95301.0084	5743.20.00	81.95301.6234	5743.20.00
81.46711.6711	4132.00.00	81.95301.0097	5743.10.00	81.95301.6237	5743.10.00
81.46711.6712	6792.00.00	81.95301.6016	3590.20.00	81.95301.6249	5746.20.00
81.46711.6714	4133.00.00	81.95301.6030	5743.10.00	81.95301.6261	5742.10.00
81.46711.6715	6791.00.00	81.95301.6043	5743.10.00	81.95301.6267	4109.20.00
81.46711.6719	4119.00.00	81.95301.6048	5743.20.00	81.95301.6267	6425.20.00
81.46711.6723	5210.00.00	81.95301.6049	5743.20.00	81.95301.6274	5743.20.00
81.46711.6724	5564.00.00	81.95301.6050	5743.10.00	81.95301.6278	5743.20.00
81.46711.6725	5216.00.00	81.95301.6053	5743.20.00	81.95301.6279	5743.10.00
81.46711.6726	6215.00.00	81.95301.6054	5743.10.00	81.95301.6286	4126.20.00
81.46711.6728	5332.00.00	81.95301.6060	5746.20.00	81.95301.6291	4109.20.00
81.46711.6729	4119.00.00	81.95301.6068	5741.10.00	81.95301.6291	6425.20.00
81.46711.6736	4134.00.00	81.95301.6070	5742.10.00	81.95301.6297	3581.20.00
81.46711.6740	4094.00.00	81.95301.6087	5743.10.00	81.95301.6304	5805.10.00
81.46711.6759	5934.00.00	81.95301.6090	5743.20.00	81.95301.6321	5805.20.00
81.46711.6760	5934.00.00	81.95301.6091	5743.10.00	81.95301.6322	5805.10.00
81.46711.6761	5934.00.00	81.95301.6108	5743.20.00	81.95302.0039	5535.96.00

Originalni broj	FAD broj	
82.46610.6191	4136.00.00	
82.95301.0011	7474.20.00	
85.43220.6002	4569.96.00	
85.43270.6001	4151.00.00	
85.46610.6012	4146.00.00	
85.46610.6018	4149.00.00	
85.46610.6021	4117.00.00	
85.46610.6030	4115.00.00	
85.46610.6102	4115.00.00	
85.46610.6104	4116.00.00	
85.46610.6105	4141.00.00	
85.46610.6107	4143.00.00	
85.46610.6108	4138.00.00	
85.46610.6112	4146.00.00	
85.46610.6118	4149.00.00	
85.46610.6121	4117.00.00	
85.46610.6140	4117.00.00	
85.46610.6141	4141.00.00	
85.46610.6142	4146.00.00	
85.46610.6143	4143.00.00	
85.46610.6144	4138.00.00	
85.46610.6152	4149.00.00	
85.46610.6201	4115.00.00	
85.46610.6208	4138.00.00	
85.46610.6212	4146.00.00	
85.46610.6218	4149.00.00	
90.80415.3107	5741.10.00	
90.80415.3113	5741.10.00	
90.80415.4117	5742.20.00	

Originalni broj	FAD broj	Originalni broj	FAD broj	Originalni broj	FAD broj
000 268 01 81	3590.20.00	000 330 94 35	5746.10.00	000 460 06 48	5743.10.00
000 268 48 89	3590.20.00	000 330 95 35	5746.20.00	000 460 12 48	5743.10.00
000 268 52 89	3590.20.00	000 330 96 35	5746.10.00	000 460 17 48	3581.20.00
000 330 00 75	3310.96.00	000 330 98 35	4746.20.00	000 460 21 48	5774.20.00
000 330 01 48	5741.10.00	000 338 08 10	1701.10.00	000 460 26 48	5742.20.00
000 330 02 07	5117.96.00	000 338 16 10	5733.20.00	000 460 27 48	5742.20.00
000 330 02 35	5805.10.00	000 338 18 10	7414.20.00	000 460 28 05	5905.00.00
000 330 02 48	5741.20.00	000 338 20 10	1701.10.00	000 460 28 48	5743.20.00
000 330 03 35	5805.20.00	000 338 34 10	5741.20.00	000 460 29 48	5743.20.00
000 330 05 11	5128.96.00	000 338 42 10	1715.20.00	000 460 34 48	5743.10.00
000 330 06 35	5805.20.00	000 338 43 10	1715.10.00	000 460 35 48	5743.10.00
000 330 07 07	5323.96.00	000 338 44 10	1715.20.00	000 460 36 05	5905.00.00
000 330 07 07	5521.96.00	000 338 45 10	1715.10.00	000 460 39 05	5906.00.00
000 330 07 35	5805.10.00	000 338 50 10	1701.10.00	000 460 41 05	6887.00.00
000 330 08 35	5797.10.00	000 338 50 29	5848.10.00	000 460 41 48	5774.20.00
000 330 09 35	5797.20.00	000 338 51 10	1702.20.00	000 460 43 05	4554.00.00
000 330 11 35	5733.10.00	000 338 53 10	1701.10.00	000 460 43 48	7414.20.00
000 330 12 35	4746.20.00	000 338 54 10	1701.20.00	000 460 45 48	5774.20.00
000 330 13 35	4746.20.00	000 338 60 10	1715.10.00	000 460 48 48	4489.20.00
000 330 14 11	3935.96.00	000 338 61 10	1715.20.00	000 460 49 48	5904.20.00
000 330 14 35	3713.20.00	000 338 62 10	1715.10.00	000 460 51 05	5905.00.00
000 330 14 35	5746.20.00	000 350 01 05	3500.90.00	000 460 55 05	6887.00.00
000 330 15 35	5746.20.00	000 350 01 13	3769.96.00	000 460 56 48	7414.20.00
000 330 19 35	5848.10.00	000 350 02 05	3956.90.00	000 460 57 48	5855.20.00
000 330 20 11	4569.96.00	000 350 02 13	3755.90.00	000 460 58 48	5855.10.00
000 330 22 11	5128.96.00	000 350 02 13	3957.90.00	000 460 60 48	5855.20.00
000 330 26 35	3692.10.00	000 350 03 05	3755.90.00	000 460 61 48	5855.10.00
000 330 27 35	3692.20.00	000 350 03 05	3957.90.00	000 460 68 48	5855.20.00
000 330 29 35	5848.10.00	000 350 04 13	3765.96.00	000 460 69 48	5855.10.00
000 330 31 35	5748.20.00	000 350 05 05	3755.90.00	000 460 70 48	5855.20.00
000 330 32 35	5741.20.00	000 350 05 05	3957.90.00	000 460 71 05	4529.00.00
000 330 33 35	3713.10.00	000 350 05 06	5170.96.00	000 460 71 48	5855.10.00
000 330 33 35	5746.10.00	000 350 06 13	3744.96.00	000 460 72 05	4529.00.00
000 330 40 35	5848.20.00	000 350 10 05	6021.96.00	000 460 72 48	1074.20.00
000 330 41 35	5848.10.00	000 350 10 13	5847.90.00	000 460 75 48	5855.20.00
000 330 49 29	5848.20.00	000 350 11 05	5705.96.00	000 460 77 48	5369.20.00
000 330 50 35	5774.20.00	000 350 14 05	3950.90.00	000 460 78 48	5369.10.00
000 330 56 35	7414.20.00	000 350 20 05	5367.96.00	000 460 83 48	5741.20.00
000 330 68 35	5805.10.00	000 350 21 05	3936.96.00	000 460 84 48	4489.10.00
000 330 69 35	3692.10.00	000 350 22 05	4482.96.00	000 460 85 48	5774.20.00
000 330 70 35	3692.20.00	000 350 23 05	4483.96.00	000 460 92 05	4495.00.00
000 330 72 35	5746.10.00	000 350 24 05	4484.96.00	000 460 93 05	4495.00.00
000 330 77 35	5848.20.00	000 350 25 05	6023.96.00	000 460 95 05	4528.00.00
000 330 78 35	5848.10.00	000 350 28 05	4492.96.00	000 460 98 05	4531.00.00
000 330 81 35	5748.20.00	000 350 28 05	5944.96.00	000 460 99 05	4531.00.00
000 330 85 35	5805.20.00	000 350 29 05	4490.96.00	000 463 23 29	5899.20.00
000 330 86 35	5805.10.00	000 360 098 524	3302.00.00	000 463 24 29	5900.20.00
000 330 87 35	5805.20.00	000 390 098 524	3302.00.00	000 463 25 29	5900.20.00
000 330 88 35	5805.10.00	000 460 01 48	5742.20.00	000 463 26 29	5899.20.00
000 330 93 35	5746.20.00	000 460 03 48	5743.20.00	000 463 32 29	5805.20.00

Originalni broj	FAD broj	Originalni broj	FAD broj	Originalni broj	FAD broj
000 463 34 29	5741.20.00	001 460 17 48	5855.20.00	300 460 04 05	5835.00.00
000 463 40 29	7523.20.00	001 460 20 48	5369.10.00	300 460 05 05	5835.00.00
000 463 41 29	7523.20.00	001 460 21 48	5369.20.00	300 460 06 05	5283.00.00
000 586 01 32	3757.90.00	001 460 22 48	5743.20.00	300 460 07 05	5283.00.00
000 586 06 32	3991.95.00	001 460 24 48	5855.20.00	301 330 00 11	3605.38.00
000 586 07 32	3757.95.00	001 460 29 05	3973.00.00	301 460 00 05	5875.00.00
000 586 09 32	5854.90.00	001 460 30 05	3973.00.00	301 460 01 05	5875.00.00
000 586 10 35	5846.90.00	001 460 42 48	6881.20.00	301 460 05 05	5835.00.00
000 586 11 35	3744.96.00	001 460 44 48	5741.20.00	302 330 00 35	5741.10.00
000 586 12 35	3765.96.00	001 460 50 48	6881.20.00	302 330 01 03	3734.00.00
000 586 14 33	3755.90.00	001 460 62 05	4504.00.00	302 330 01 35	5741.10.00
000 586 14 33	3957.90.00	001 460 63 05	4510.00.00	302 330 02 35	5741.10.00
000 586 15 33	3755.95.00	001 460 67 05	4529.00.00	302 330 03 03	3735.00.00
000 586 19 33	3500.95.00	001 460 69 05	4495.00.00	302 330 03 11	5786.38.00
001 330 01 35	5741.20.00	001 460 70 05	4519.00.00	302 330 03 35	5741.10.00
001 330 02 35	5741.20.00	001 460 71 05	4528.00.00	302 330 04 03	3734.00.00
001 330 03 35	5748.20.00	001 460 73 05	4548.00.00	302 330 06 03	3735.00.00
001 330 04 35	5748.20.00	001 460 76 48	5855.20.00	302 330 07 03	3734.00.00
001 330 07 35	3692.20.00	001 460 85 05	4510.00.00	302 330 09 03	5725.00.00
001 330 08 35	3692.10.00	001 460 85 48	6881.20.00	302 330 09 03	5837.00.00
001 330 09 35	3692.20.00	001 460 86 05	4515.00.00	302 330 11 03	5862.00.00
001 330 10 35	3692.10.00	001 460 87 05	4515.00.00	302 330 13 03	5725.00.00
001 330 10 35	5733.20.00	001 460 89 05	4505.00.00	302 330 13 03	5837.00.00
001 330 12 35	5733.20.00	001 460 96 05	5889.00.00	302 330 14 03	5862.00.00
001 330 14 35	5733.20.00	001 460 98 05	4563.00.00	302 330 15 03	5725.00.00
001 330 18 35	5856.20.00	001 460 99 05	4563.00.00	302 330 15 03	5837.00.00
001 330 21 35	5848.20.00	002 460 04 05	4568.00.00	302 330 16 03	5862.00.00
001 330 22 35	5848.10.00	002 460 05 05	4551.00.00	302 330 17 03	5725.00.00
001 330 26 35	5848.20.00	002 460 12 05	4504.00.00	302 330 17 03	5837.00.00
001 330 27 35	5848.10.00	002 460 13 05	4505.00.00	302 330 18 03	3735.00.00
001 330 48 35	1074.20.00	002 460 43 05	6881.00.00	302 460 05 05	5728.00.00
001 330 88 35	5741.10.00	002 460 44 05	6881.00.00	302 460 06 05	5728.00.00
001 460 03 05	4533.00.00	002 460 45 05	6882.00.00	302 460 06 05	5794.00.00
001 460 04 05	4533.00.00	002 460 46 05	6882.00.00	302 460 14 05	5794.00.00
001 460 05 05	4545.00.00	002 460 47 05	4527.00.00	302 460 16 05	5721.00.00
001 460 05 48	5855.10.00	002 460 48 05	4527.00.00	302 460 18 05	5721.00.00
001 460 06 05	4545.00.00	002 460 49 05	4539.00.00	302 460 20 05	5794.00.00
001 460 06 48	4489.20.00	002 460 50 05	4539.00.00	302 460 24 05	5721.00.00
001 460 07 05	4519.00.00	002 460 51 05	4549.00.00	302 460 33 05	5727.00.00
001 460 07 48	4489.10.00	002 460 52 05	4549.00.00	302 460 34 05	5727.00.00
001 460 08 05	4519.00.00	002 460 63 05	4541.00.00	302 460 37 05	5721.00.00
001 460 11 05	4568.00.00	002 460 64 05	4563.00.00	302 460 38 05	5721.00.00
001 460 11 48	5855.20.00	002 460 96 05	4525.00.00	302 460 39 05	5728.00.00
001 460 13 05	4551.00.00	002 460 97 05	4525.00.00	302 460 40 05	5728.00.00
001 460 13 48	5855.10.00	003 460 32 05	4551.00.00	305 330 04 03	5282.00.00
001 460 14 05	4551.00.00	003 460 46 05	4524.00.00	305 330 06 11	5785.38.00
001 460 14 48	5743.10.00	080 460 67 05	4516.00.00	305 330 08 03	5282.00.00
001 460 15 05	4548.00.00	124 330 08 03	1702.00.00	305 330 10 03	5282.00.00
001 460 15 48	4558.20.00	300 460 02 05	5875.00.00	305 330 11 03	5282.00.00
001 460 16 48	4558.20.00	300 460 03 05	5875.00.00	305 460 03 05	5283.00.00

Originalni broj	FAD broj	Originalni broj	FAD broj	Originalni broj	FAD broj
305 460 04 05	5893.00.00	310 330 09 03	5826.00.00	327 460 00 05	5778.00.00
305 460 06 05	5887.00.00	310 330 10 03	5827.00.00	327 460 06 05	5825.00.00
307 330 01 11	3310.00.00	310 330 10 35	7414.20.00	327 460 16 05	5825.00.00
307 330 01 11	5854.00.00	310 330 11 03	5826.00.00	335 460 05 05	3728.00.00
307 460 00 05	5843.00.00	310 330 12 03	5827.00.00	335 460 07 05	3728.00.00
307 460 04 05	5280.00.00	310 330 12 35	7414.20.00	335 460 08 05	3728.00.00
307 460 05 05	5843.00.00	310 330 13 35	5774.20.00	343 320 16 32	3756.00.00
309 330 06 03	5704.00.00	310 330 16 35	5896.10.00	343 320 16 32	3991.00.00
309 330 07 03	5704.00.00	310 330 17 35	5896.20.00	343 320 16 32	3992.00.00
309 330 08 03	5704.00.00	310 330 18 35	5897.20.00	343 320 17 32	3756.00.00
309 330 11 03	5704.00.00	310 330 19 35	5897.10.00	343 320 17 32	3991.00.00
309 330 12 03	3692.00.00	310 330 20 35	5896.20.00	343 320 17 32	3992.00.00
309 330 13 03	3692.00.00	310 330 21 35	5896.10.00	343 320 18 32	3756.00.00
309 330 14 03	3692.00.00	310 330 22 35	5897.20.00	343 320 18 32	3991.00.00
309 330 16 03	3692.00.00	310 330 23 35	5897.10.00	343 320 18 32	3992.00.00
309 330 17 03	3692.00.00	310 330 24 35	5896.20.00	343 330 01 03	5731.00.00
309 330 18 03	3692.00.00	310 330 25 35	5896.10.00	343 330 01 03	5817.00.00
309 330 19 03	3692.00.00	310 330 26 35	5897.20.00	343 330 03 03	5731.00.00
309 330 20 03	3692.00.00	310 330 27 35	5897.10.00	343 330 03 03	5817.00.00
309 330 21 03	3692.00.00	313 460 01 05	3918.00.00	343 330 04 03	5731.00.00
309 460 03 05	5775.00.00	314 330 03 03	5737.00.00	343 330 04 03	5817.00.00
309 460 04 05	5775.00.00	314 460 03 05	5776.00.00	343 460 04 05	5820.00.00
309 460 05 05	5775.00.00	314 460 08 05	5777.00.00	343 460 08 05	5820.00.00
309 460 08 05	5775.00.00	316 330 02 03	5823.00.00	343 460 10 05	5820.00.00
309 460 09 05	5775.00.00	316 330 06 03	5823.00.00	343 460 12 05	5820.00.00
309 460 10 05	5775.00.00	316 330 07 03	5823.00.00	343 460 14 05	5820.00.00
309 460 11 05	5775.00.00	316 460 06 05	5720.00.00	343 460 15 05	5820.00.00
309 460 12 05	5775.00.00	316 460 07 05	5720.00.00	343 586 00 32	3991.90.00
309 460 13 05	5775.00.00	316 460 08 05	5720.00.00	346 330 29 03	5807.00.00
309 460 14 05	5775.00.00	316 460 09 05	5720.00.00	346 330 39 03	5871.00.00
309 460 20 05	5775.00.00	317 330 02 11	3608.38.00	346 330 43 03	5807.00.00
309 460 22 05	5775.00.00	317 330 04 11	3609.38.00	346 330 44 03	5807.00.00
309 460 23 05	5775.00.00	317 330 05 11	5783.38.00	346 330 45 03	3730.00.00
309 460 24 05	5775.00.00	317 350 06 06	3604.38.00	346 330 49 03	5871.00.00
309 460 25 05	5775.00.00	317 350 07 06	3602.38.00	346 330 5003	3739.00.00
309 460 26 05	5775.00.00	317 460 57 05	5881.00.00	346 330 51 03	3730.00.00
309 460 29 05	5775.00.00	317 460 58 05	5881.00.00	350 330 71 35	5741.10.00
309 460 30 05	5775.00.00	317 460 61 05	5719.00.00	352 330 02 03	5806.00.00
309 460 31 05	5775.00.00	317 460 63 05	5724.00.00	352 330 17 03	5814.00.00
309 460 32 05	5775.00.00	317 460 65 05	5718.00.00	352 330 18 03	5818.00.00
310 330 00 35	5896.20.00	317 460 66 05	5718.00.00	352 330 19 03	5804.00.00
310 330 01 35	5896.10.00	317 460 67 05	5729.00.00	352 330 20 03	5804.00.00
310 330 02 35	5897.20.00	317 460 69 05	5882.00.00	352 330 23 03	5804.00.00
310 330 03 35	5897.10.00	317 460 70 05	5718.00.00	352 330 24 03	5804.00.00
310 330 04 35	5774.20.00	317 460 71 05	5882.00.00	352 330 25 03	5814.00.00
310 330 06 03	5827.00.00	317 460 72 05	5718.00.00	352 330 26 03	5818.00.00
310 330 06 35	7414.20.00	322 330 10 11	3601.38.00	352 330 27 03	5814.00.00
310 330 07 03	5826.00.00	327 330 01 03	5806.00.00	352 330 28 03	5818.00.00
310 330 08 03	5827.00.00	327 330 03 03	5806.00.00	352 350 03 06	5840.00.00
310 330 08 35	5774.20.00	327 330 04 03	5806.00.00	352 350 04 06	3757.00.00

Originalni broj	FAD broj	Originalni broj	FAD broj	Originalni broj	FAD broj
352 460 10 05	3736.00.00	357 330 11 03	6901.00.00	373 460 09 05	5728.00.00
352 460 19 05	3736.00.00	357 330 15 03	6901.00.00	373 460 35 05	5722.00.00
352 460 21 05	5816.00.00	357 330 17 11	3952.00.00	373 460 36 05	5722.00.00
352 460 22 05	5740.00.00	357 330 19 11	6910.00.00	375 460 16 05	4548.00.00
352 460 23 05	3914.00.00	357 330 31 11	3601.38.00	381 330 03 03	3738.00.00
352 460 27 05	3736.00.00	357 330 33 11	6910.00.00	381 330 03 03	5747.00.00
352 460 28 05	3922.00.00	357 330 34 11	3604.38.00	381 330 05 03	3738.00.00
352 460 29 05	5816.00.00	357 330 36 11	3310.00.00	381 330 05 03	5747.00.00
352 460 30 05	5740.00.00	357 330 36 11	5854.00.00	381 330 06 03	3738.00.00
352 460 31 05	3914.00.00	357 330 42 11	3609.38.00	381 330 06 03	5747.00.00
352 460 32 05	3914.00.00	357 333 02 05	5956.00.00	381 330 07 03	3738.00.00
352 460 33 05	5779.00.00	357 333 04 05	6039.00.00	381 330 07 03	5747.00.00
352 460 35 05	3733.00.00	357 333 05 05	6905.00.00	381 350 02 06	5770.00.00
352 460 37 05	3723.00.00	357 333 06 05	4488.00.00	381 350 03 06	3697.00.00
352 460 44 05	3736.00.00	357 333 07 05	6906.00.00	381 350 06 06	5705.00.00
352 460 46 05	5816.00.00	357 333 09 05	4488.00.00	381 350 06 06	5846.00.00
352 460 48 05	3914.00.00	357 460 04 05	5865.00.00	383 330 03 11	3431.00.00
352 460 49 05	3914.00.00	357 460 10 05	5865.00.00	383 350 00 06	5770.00.00
352 460 54 05	3736.00.00	357 460 11 05	5865.00.00	383 350 01 05	3503.00.00
352 460 55 05	5816.00.00	357 460 12 05	5887.00.00	383 460 08 05	5748.00.00
352 460 56 05	3914.00.00	357 460 13 05	5887.00.00	383 460 14 05	5734.00.00
352 460 57 05	3922.00.00	357 460 14 05	3967.00.00	383 460 16 05	5748.00.00
352 460 58 05	5740.00.00	357 460 15 05	3967.00.00	383 460 24 05	5748.00.00
352 460 66 05	3723.00.00	357 460 32 05	6902.00.00	383 460 45 05	5748.00.00
352 460 71 05	3723.00.00	358 330 00 03	5806.00.00	385 330 01 03	5730.00.00
353 330 03 03	5805.00.00	358 330 01 03	3738.00.00	385 330 02 03	3968.00.00
353 330 04 03	5805.00.00	358 330 01 03	5747.00.00	385 330 04 03	5869.00.00
353 330 05 03	5805.00.00	358 330 05 03	3738.00.00	385 330 05 03	5741.00.00
353 330 06 03	5805.00.00	358 330 05 03	5747.00.00	385 330 06 03	5741.00.00
355 460 09 05	3919.00.00	358 330 07 03	5806.00.00	385 330 08 03	3968.00.00
355 460 15 05	3305.00.00	358 330 08 03	5806.00.00	385 330 11 03	5741.00.00
355 460 23 05	4526.00.00	360 460 02 05	5779.00.00	385 330 12 03	5730.00.00
355 460 28 05	4526.00.00	360 460 03 05	5885.00.00	385 330 14 03	5741.00.00
355 460 35 05	3919.00.00	360 460 08 05	5779.00.00	385 330 15 03	5741.00.00
355 460 47 05	4526.00.00	360 460 09 05	5885.00.00	385 330 16 03	3968.00.00
355 460 51 05	3919.00.00	360 460 21 05	5779.00.00	385 330 18 03	3968.00.00
355 460 59 05	3305.00.00	360 460 22 05	5885.00.00	385 330 19 03	5730.00.00
355 460 60 05	3305.00.00	363 460 00 05	3693.00.00	385 330 19 03	5869.00.00
356 330 00 03	6050.00.00	363 460 00 05	5792.00.00	385 330 20 03	5730.00.00
356 330 01 03	6054.00.00	363 460 06 05	5792.00.00	385 330 20 03	5869.00.00
356 330 02 03	6051.00.00	363 460 07 05	5792.00.00	385 350 00 06	5773.00.00
356 350 01 06	5708.00.00	365 460 06 05	3724.00.00	385 350 00 06	5891.00.00
356 463 00 15	6053.00.00	366 460 07 05	3725.00.00	385 350 01 06	3751.00.00
356 463 02 15	6052.00.00	366 460 08 05	3726.00.00	385 350 02 06	3697.00.00
357 330 00 35	5522.96.00	371 330 70 03	5743.00.00	385 460 08 05	5799.00.00
357 330 02 03	3444.00.00	373 460 03 05	5722.00.00	385 460 20 05	5799.00.00
357 330 04 03	3444.00.00	373 460 05 05	5722.00.00	385 460 34 05	5799.00.00
357 330 05 03	3444.00.00	373 460 06 05	5728.00.00	387 460 00 05	3720.00.00
357 330 06 03	5976.00.00	373 460 07 05	5722.00.00	387 460 00 05	5793.00.00
357 330 07 03	5976.00.00	373 460 08 05	5721.00.00	387 460 04 05	5749.00.00

Originalni broj	FAD broj	Originalni broj	FAD broj	Originalni broj	FAD broj
387 460 06 05	5812.00.00	395 350 00 06	3765.00.00	602 330 01 03	5886.00.00
387 460 07 05	5811.00.00	395 350 02 06	3744.00.00	602 330 02 35	5895.20.00
387 460 07 05	5839.00.00	395 350 02 06	5842.00.00	602 330 03 03	5886.00.00
387 460 14 05	5811.00.00	395 350 05 06	3471.00.00	602 330 03 35	5895.20.00
387 460 14 05	5839.00.00	395 350 06 06	5844.00.00	602 330 04 03	5886.00.00
387 460 15 05	5860.00.00	395 350 07 06	3745.00.00	602 330 09 03	3924.00.00
387 460 15 05	5873.00.00	395 350 08 06	3764.00.00	602 330 09 03	5703.00.00
387 460 32 05	5811.00.00	395 350 10 06	3690.00.00	602 330 10 03	3924.00.00
387 460 32 05	5839.00.00	395 350 10 06	5845.00.00	602 330 10 03	5703.00.00
387 460 33 05	5811.00.00	395 350 11 06	3762.00.00	602 330 53 03	3924.00.00
387 460 33 05	5839.00.00	395 350 11 06	3767.00.00	602 330 53 03	5703.00.00
387 460 35 05	5860.00.00	395 350 12 06	3762.00.00	602 330 54 03	3924.00.00
387 460 35 05	5873.00.00	395 350 12 06	3767.00.00	602 330 54 03	5703.00.00
387 460 36 05	5860.00.00	395 350 13 06	3691.00.00	602 330 55 03	5886.00.00
387 460 36 05	5873.00.00	395 350 13 06	3769.00.00	608 330 04 03	1708.00.00
387 460 44 05	5812.00.00	396 460 30 05	3958.00.00	613 330 00 03	6050.00.00
387 460 45 05	5812.00.00	396 460 31 05	3959.00.00	613 330 01 03	6054.00.00
387 460 48 05	5793.00.00	396 460 48 05	3958.00.00	613 463 00 15	6053.00.00
387 460 49 05	5793.00.00	396 460 49 05	3959.00.00	617 330 02 03	3978.00.00
387 460 50 05	5749.00.00	396 460 53 05	4512.00.00	617 330 03 03	3978.00.00
389 320 07 32	5771.00.00	406 460 01 05	4552.00.00	617 460 00 05	5821.00.00
389 320 08 32	5772.00.00	424 330 03 03	4550.00.00	617 460 02 05	5821.00.00
389 330 01 03	3722.00.00	427 460 00 05	4560.00.00	617 460 24 05	3969.00.00
391 330 04 03	3716.00.00	427 460 01 05	4560.00.00	617 460 28 05	5821.00.00
391 330 06 03	5872.00.00	427 460 03 05	4560.00.00	617 460 32 05	5890.00.00
391 330 07 03	3716.00.00	427 460 04 05	4560.00.00	617 460 33 05	5890.00.00
391 330 08 03	5872.00.00	440 460 03 48	3965.20.00	617 460 34 05	3969.00.00
391 330 09 03	3716.00.00	440 460 03 48	7385.20.00	619 460 04 05	3988.00.00
391 330 10 03	5872.00.00	440 460 05 48	3965.20.00	619 460 06 05	3999.00.00
391 330 11 03	3716.00.00	444 333 01 27	6409.96.00	619 460 19 05	3988.00.00
391 330 12 03	5872.00.00	460 330 12 35	1074.20.00	619 460 20 05	4546.00.00
391 460 09 05	3987.00.00	600 330 00 11	3605.38.00	619 460 21 05	3999.00.00
391 460 17 05	3987.00.00	600 330 01 11	3602.38.00	619 460 25 05	3708.00.00
391 460 18 05	3987.00.00	601 330 04 35	5886.20.00	619 460 29 05	3708.00.00
393 320 01 32	3742.00.00	601 330 05 35	5886.10.00	619 460 45 05	3988.00.00
393 320 02 32	3753.00.00	601 460 00 05	5775.00.00	619 460 46 05	4546.00.00
393 320 03 32	3758.00.00	601 460 01 05	5775.00.00	619 460 47 05	3999.00.00
393 320 04 32	3754.00.00	601 460 02 05	5775.00.00	619 460 52 05	3708.00.00
393 330 00 03	5743.00.00	601 460 03 05	5775.00.00	620 330 02 11	3433.00.00
393 330 02 03	5743.00.00	601 460 05 05	5852.00.00	620 330 03 03	5836.00.00
393 330 03 03	5743.00.00	601 460 06 05	5852.00.00	620 330 03 11	3435.00.00
393 330 04 03	5743.00.00	601 460 07 05	5852.00.00	620 330 04 03	5836.00.00
393 350 52 05	3503.00.00	601 460 08 05	5852.00.00	620 330 05 03	5864.00.00
393 350 53 05	3503.00.00	601 460 09 05	5852.00.00	620 330 06 03	5864.00.00
393 350 54 05	3503.00.00	601 460 10 05	5852.00.00	620 330 07 03	5836.00.00
393 350 55 05	3503.00.00	601 460 11 05	5852.00.00	620 330 08 03	5836.00.00
395 320 01 32	3752.00.00	601 460 12 05	5852.00.00	620 350 00 06	5851.00.00
395 320 03 32	3751.00.00	601 460 13 05	5852.00.00	620 350 00 06	5858.00.00
395 320 14 32	3755.00.00	601 460 15 05	5852.00.00	620 350 01 06	5851.00.00
395 320 15 32	5739.00.00	602 330 00 03	5886.00.00	620 350 01 06	5858.00.00

Originalni broj	FAD broj	Originalni broj	FAD broj	Originalni broj	FAD broj
620 460 00 05	5749.00.00	625 460 43 05	5905.00.00	654 352 00 05	5849.00.00
620 460 01 05	5822.00.00	625 460 43 05	5906.00.00	655 330 00 11	3434.00.00
620 460 04 05	3971.00.00	625 460 44 05	3923.00.00	655 350 00 06	3742.00.00
620 460 08 05	3971.00.00	625 460 48 05	4554.00.00	655 350 03 05	3503.00.00
620 460 20 05	5749.00.00	625 460 52 05	5906.00.00	655 350 03 06	5851.00.00
620 460 21 05	5822.00.00	625 460 77 05	5905.00.00	655 350 03 06	5858.00.00
620 460 24 05	3938.00.00	625 460 78 05	6887.00.00	658 350 00 05	3503.00.00
620 460 26 05	3938.00.00	625 460 79 05	5906.00.00	658 350 00 06	3742.00.00
620 460 28 05	5749.00.00	628 333 00 03	6885.00.00	658 350 02 06	3742.00.00
620 460 29 05	3971.00.00	628 333 00 05	6885.00.00	659 350 01 06	3744.00.00
620 460 30 05	3971.00.00	628 333 10 05	6885.00.00	659 350 01 06	5842.00.00
620 460 37 05	5749.00.00	628 333 18 05	6885.00.00	659 350 04 06	3745.00.00
620 460 38 05	5822.00.00	629 350 05 06	6197.00.00	659 350 09 06	3762.00.00
620 460 39 05	5822.00.00	629 350 06 06	6197.00.00	659 350 09 06	3767.00.00
620 460 40 05	3938.00.00	629 350 12 06	4566.00.00	659 350 11 06	3765.00.00
620 460 41 05	3938.00.00	629 350 28 06	4566.00.00	659 350 12 06	3759.00.00
622 460 02 05	3976.00.00	631 330 03 03	1703.00.00	659 350 13 06	3690.00.00
622 460 03 05	3976.00.00	631 330 04 03	1705.00.00	659 350 13 06	5845.00.00
622 460 04 05	3975.00.00	631 330 04 10	1703.10.00	659 350 14 06	3761.00.00
622 460 09 05	3976.00.00	631 330 04 35	1704.20.00	659 350 15 06	3768.00.00
622 460 10 05	3976.00.00	631 330 05 03	1704.00.00	659 350 16 06	3691.00.00
622 460 14 05	3975.00.00	631 330 06 03	1706.00.00	659 350 16 06	3769.00.00
622 460 15 05	3975.00.00	631 330 07 03	1704.00.00	659 350 17 06	3760.00.00
624 350 00 06	3765.00.00	631 338 03 10	1703.20.00	659 350 24 06	3744.00.00
624 350 01 06	3759.00.00	631 460 07 05	4536.00.00	659 350 24 06	5842.00.00
624 350 02 06	3690.00.00	634 460 05 05	3492.00.00	659 350 27 06	3745.00.00
624 350 02 06	5845.00.00	647 460 00 05	5811.00.00	659 350 32 06	3762.00.00
624 350 03 06	3761.00.00	647 460 00 05	5839.00.00	659 350 32 06	3767.00.00
624 350 04 06	3768.00.00	647 460 01 05	5811.00.00	659 350 34 06	3765.00.00
624 350 05 06	3691.00.00	647 460 01 05	5839.00.00	659 350 35 06	3759.00.00
624 350 05 06	3769.00.00	647 460 02 05	5860.00.00	659 350 36 06	3690.00.00
625 330 03 03	4458.00.00	647 460 02 05	5873.00.00	659 350 36 06	5845.00.00
625 330 04 03	5874.00.00	647 460 03 05	5860.00.00	659 350 37 06	3761.00.00
625 330 09 03	3937.00.00	647 460 03 05	5873.00.00	659 350 38 06	3768.00.00
625 330 12 03	3937.00.00	652 350 03 06	5705.00.00	659 350 39 06	3691.00.00
625 330 15 03	3974.00.00	652 350 03 06	5846.00.00	659 350 39 06	3769.00.00
625 330 16 03	3974.00.00	653 330 00 11	3432.00.00	667 460 15 05	4534.00.00
625 330 20 03	4458.00.00	653 350 00 06	5773.00.00	667 460 17 05	4534.00.00
625 330 21 03	4458.00.00	653 350 00 06	5891.00.00	668 460 05 05	3916.00.00
625 330 24 03	3974.00.00	653 350 01 05	3503.00.00	668 460 07 05	3916.00.00
625 330 25 03	3974.00.00	653 350 01 06	5705.00.00	668 460 09 05	3916.00.00
625 330 26 03	3977.00.00	653 350 01 06	5846.00.00	668 460 11 05	3916.00.00
625 330 26 03	4458.00.00	653 353 00 05	3503.00.00	668 460 15 05	3917.00.00
625 330 27 03	3977.00.00	654 330 00 11	3431.00.00	668 460 17 05	3917.00.00
625 330 27 03	4458.00.00	654 330 01 11	3431.00.00	668 460 19 05	3917.00.00
625 330 32 03	4567.00.00	654 350 04 06	5706.00.00	668 460 21 05	4535.00.00
625 350 01 06	3699.00.00	654 350 04 06	5849.00.00	668 460 22 05	4535.00.00
625 460 25 05	5907.00.00	654 350 05 06	5706.00.00	669 330 04 03	5828.00.00
625 460 38 05	5906.00.00	654 350 05 06	5849.00.00	669 330 05 03	5828.00.00
625 460 42 05	6887.00.00	654 352 00 05	5706.00.00	670 330 00 03	5828.00.00

MERCEDES-BENZ/FAD



Originalni broj	FAD broj	Originalni broj	FAD broj	Originalni broj	FAD broj
670 330 01 03	5828.00.00	730 600	5826.00.00	949 330 12 03	4511.00.00
670 330 02 03	5828.00.00	901 460 01 48	1711.20.00	949 330 13 03	4511.00.00
670 330 03 03	5828.00.00	901 460 03 48	1711.20.00	949 330 14 03	4559.00.00
670 460 08 05	5365.00.00	941 330 00 03	4450.00.00	949 330 17 03	4522.00.00
670 460 12 05	5365.00.00	941 330 00 07	3303.00.00	949 330 18 03	4511.00.00
670 460 16 05	5365.00.00	941 330 00 11	3302.00.00	970 330 00 03	4471.00.00
670 460 20 05	5365.00.00	941 330 01 03	4450.00.00	970 330 01 03	4471.00.00
670 460 26 05	5363.00.00	941 330 02 03	4450.00.00	970 330 02 03	4471.00.00
670 460 27 05	5363.00.00	941 330 03 03	4450.00.00	970 330 03 03	4471.00.00
671 333 01 05	6904.00.00	942 330 00 03	4496.00.00	970 330 04 03	4471.00.00
671 333 02 05	6905.00.00	942 330 01 03	4496.00.00	970 460 07 05	4514.00.00
671 333 04 05	6906.00.00	942 330 02 03	4496.00.00	970 460 08 05	4562.00.00
671 460 02 05	6900.00.00	942 330 03 03	4457.00.00	970 460 09 05	4514.00.00
671 460 03 05	6902.00.00	942 330 04 03	4457.00.00	970 460 10 05	4562.00.00
673 460 02 05	5888.00.00	942 330 05 03	4458.00.00	972 460 14 05	4532.00.00
673 460 03 05	5831.00.00	942 330 06 03	4458.00.00	972 460 15 05	4561.00.00
673 460 04 05	5888.00.00	942 330 07 03	4496.00.00	972 460 16 05	4532.00.00
673 460 05 05	5831.00.00	942 330 08 03	4459.00.00	972 460 17 05	4561.00.00
673 460 06 05	5888.00.00	942 330 09 03	4458.00.00	972 460 18 05	4513.00.00
673 460 07 05	5831.00.00	942 330 11 03	4496.00.00	972 460 20 05	4513.00.00
673 460 08 05	5888.00.00	942 330 16 03	4457.00.00	974 460 10 05	4524.00.00
673 460 09 05	5831.00.00	942 350 10 05	4480.00.00	974 460 11 05	4565.00.00
675 460 10 05	3306.00.00	944 330 02 03	3937.00.00	974 460 12 05	4524.00.00
675 460 12 05	3972.00.00	944 330 17 03	4567.00.00	974 460 13 05	4565.00.00
675 460 13 05	5631.00.00	944 350 00 05	4480.00.00	975 330 02 03	4474.00.00
675 460 16 05	3306.00.00	945 330 00 03	4553.00.00	975 330 03 03	4474.00.00
675 460 18 05	3972.00.00	945 330 00 07	3301.00.00	975 330 08 03	4474.00.00
675 460 19 05	5631.00.00	945 330 00 11	3304.00.00	975 330 17 03	4474.00.00
675 460 22 05	3306.00.00	945 330 01 03	4553.00.00	SA 508 316 / 01	3302.00.00
675 460 24 05	3972.00.00	945 330 02 03	4451.00.00	SA 508 316 / 02	3304.00.00
675 460 25 05	5631.00.00	945 330 03 03	4451.00.00		
675 460 28 05	3306.00.00	945 330 04 03	4553.00.00		
675 460 30 05	3972.00.00	945 330 05 03	4451.00.00		
675 460 31 05	5631.00.00	945 330 06 03	4553.00.00		
676 330 02 03	5829.00.00	945 350 01 05	6407.00.00		
676 330 04 03	5829.00.00	947 350 00 05	3979.00.00		
676 330 07 03	5829.00.00	947 350 01 05	4480.00.00		
676 330 08 03	5863.00.00	947 350 10 05	4480.00.00		
676 330 09 03	5829.00.00	948 350 06 05	3979.00.00		
676 330 10 03	5863.00.00	948 350 12 05	3979.00.00		
676 460 01 05	3307.00.00	948 350 13 05	3979.00.00		
676 460 06 05	3307.00.00	948 350 25 05	6407.00.00		
676 460 11 05	3307.00.00	949 330 02 03	4459.00.00		
676 460 12 05	4564.00.00	949 330 03 03	4459.00.00		
676 460 15 05	3307.00.00	949 330 04 03	4559.00.00		
676 460 16 05	4564.00.00	949 330 05 03	4559.00.00		
677 330 03 03	5866.00.00	949 330 08 03	4559.00.00		
677 330 04 03	5866.00.00	949 330 09 03	4459.00.00		
699 460 16 48	5536.20.00	949 330 10 03	4522.00.00		
730 505	5826.00.00	949 330 11 03	4522.00.00		

Originalni broj	FAD broj
143 929	4440.00.00
144 228	4441.00.00
377 740	5928.00.00
4922-02/1962	4345.00.00
619 687	7720.20.00
654 136	5746.10.00
660 856	3582.00.00
660 857	5743.10.00
660 858	5743.20.00
660 915	3581.00.00
660 916	3581.10.00
660 917	3581.20.00
660 976	3586.00.00
660 977	3584.00.00
665 178	3587.00.00
665 196	3579.00.00
665 197	3573.00.00
678 612	3576.00.00
678 621	5741.10.00
678 622	5741.20.00
683 795	3595.00.00
685 201	3593.00.00
699 432	3597.00.00
700 875	3598.00.00
737 710	3599.00.00
783.24.3143.000	4337.00.00
832.00.3183.000	5198.00.00
832 45	3583.00.00
836.01.3504.000	5914.00.00
837 57	4333.00.00
839.53.3143.000	4333.00.00
863 97	4337.00.00
900 20	3585.00.00
900 81	3588.00.00
917 20	3646.00.00
918 42	4345.00.00
996 56	4387.00.00
997 324	5927.00.00
A4815-20	4334.00.00
A4815-21	4335.00.00
A4815-22	4336.00.00

Originalni broj	FAD broj	Originalni broj	FAD broj	Originalni broj	FAD broj
00 00 566 157	5980.00.00	50 00 295 215	5741.10.00	50 10 037 602	3948.00.00
00 00 691 970	3283.00.00	50 00 516 214	3590.20.00	50 10 037 603	3948.00.00
00 00 745 019	5981.00.00	50 00 559 336	5746.10.00	50 10 060 764	3297.00.00
00 03 401 149	5998.20.00	50 00 590 236	5743.20.00	50 10 064 641	5985.00.00
00 03 401 150	5998.10.00	50 00 613 837	4679.00.00	50 10 094 838	5985.00.00
00 03 401 170	5743.10.00	50 00 725 267	3296.00.00	50 10 094 839	4690.00.00
00 03 401 206	5856.10.00	50 00 748 868	3293.00.00	50 10 094 840	3282.00.00
00 03 401 207	5856.20.00	50 00 748 868	3298.00.00	50 10 094 941	5985.00.00
00 03 406 169	5743.20.00	50 00 750 976	5985.00.00	50 10 097 562	6359.00.00
00 03 406 212	5741.20.00	50 00 783 574	5985.00.00	50 10 098 467	4675.00.00
00 03 406 213	5741.10.00	50 00 785 429	3292.00.00	50 10 104 465	5992.96.00
00 03 406 218	5741.10.00	50 00 786 532	4660.00.00	50 10 130 344	3291.00.00
00 03 406 236	5743.20.00	50 00 788 392	5983.00.00	50 10 130 453	3293.00.00
00 03 406 251	5743.20.00	50 00 791 032	4673.00.00	50 10 130 453	3298.00.00
00 03 406 252	5805.20.00	50 00 792 132	7474.20.00	50 10 130 456	3948.00.00
00 03 406 253	5741.20.00	50 00 802 123	5755.96.00	50 10 144 549	3296.00.00
00 03 406 254	5743.20.00	50 00 803 461	5998.20.00	50 10 144 552	3296.00.00
00 03 406 260	5743.20.00	50 00 803 462	5998.10.00	50 10 144543	3590.20.00
00 03 406 261	5743.20.00	50 00 804 824	5743.20.00	50 10 145 077	4666.00.00
00 23 123 159	5987.00.00	50 00 807 553	5805.10.00	50 10 145 077	5752.00.00
00 23 123 220	3289.00.00	50 00 807 554	5805.20.00	50 10 145 078	4674.00.00
00 23 123 225	5760.00.00	50 00 808 458	5742.20.00	50 10 145 584	4675.00.00
00 23 123 233	5996.00.00	50 00 810 038	5910.00.00	50 10 197 399	3286.00.00
00 23 123 237	5755.00.00	50 00 812 483	5741.20.00	50 10 207 168	3287.00.00
00 23 123 238	5757.00.00	50 00 814 096	5805.10.00	50 10 207 726	3944.00.00
00 23 123 240	5760.00.00	50 00 814 097	5805.20.00	50 10 207 727	3945.00.00
00 23 123 247	3293.00.00	50 00 814 841	3284.96.00	50 10 207 771	3288.00.00
00 23 123 247	3298.00.00	50 00 819 365	5992.96.00	50 10 216 608	4677.00.00
00 23 123 252	5983.00.00	50 00 823 947	5746.10.00	50 10 268 035	5994.00.00
00 23 123 253	5982.00.00	50 00 823 997	5746.10.00	50 10 294 287	4670.00.00
00 23 123 253	5985.00.00	50 00 874 577	3293.00.00	50 10 294 288	4668.00.00
00 23 123 262	4661.00.00	50 00 874 577	3298.00.00	50 10 294 289	4669.00.00
00 23 123 265	5759.00.00	50 01 014 520	5524.90.00	50 10 308 082	4676.00.00
00 23 123 275	5993.00.00	50 01 826 368	5760.00.00	50 10 308 214	4680.00.00
00 23 162 046	3590.20.00	50 01 831 481	5856.20.00	50 10 308 215	4673.00.00
1 151 394	3289.00.00	50 01 832 579	5856.10.00	50 10 395 796	4678.00.00
1 151 395	5755.00.00	50 01 832 580	5856.20.00	50 10 439 021	4682.00.00
1 151 396	5757.00.00	50 01 832 581	5743.10.00	50 10 439 022	4681.00.00
23 123 224	4666.00.00	50 01 840 095	3637.96.00	50 10 439 631	4675.00.00
23 123 225	5760.00.00	50 01 842 823	5170.96.00	50 10 439 984	4680.00.00
23 123 237	5755.00.00	50 01 844 135	5805.10.00	50 10 557 243	3297.00.00
23 123 238	5757.00.00	50 01 844 136	5805.20.00	50 10 566 049	4678.00.00
23 123 240	5760.00.00	50 01 850 530	5985.00.00	50 10 566 058	7762.00.00
23 123 256	5995.00.00	50 01 850 549	5741.20.00	50 10 566 059	4676.00.00
50 00 027 957	5910.00.00	50 01 850 550	5741.10.00	50 10 566 063	4682.00.00
50 00 145 581	4673.00.00	50 01 852 263	5741.10.00	50 10 587 004	4683.00.00
50 00 242 159	5741.20.00	50 01 858 763	4681.20.00	50 10 587 034	4685.00.00
50 00 288 360	5743.20.00	50 01 860 359	4672.00.00	50 10 587 038	4685.00.00
50 00 288 361	5743.10.00	50 10 005 937	3285.00.00	50 10 600 483	4686.00.00
50 00 295 214	5741.20.00	50 10 025 292	3284.00.00	50 10 600 822	4683.00.00

RENAULT/FAD



Originalni broj	FAD broj	
50 10 630 812	4687.00.00	
50 10 630 813	4687.00.00	
50 10 630 822	4684.00.00	
50 10 630 823	4684.00.00	
50 10 791 275	4673.00.00	
720 128	4667.00.00	
7420 630 813	4688.00.00	
77 01 002 911	5742.20.00	
77 01 011 267	3698.90.00	
77 01 011 412	5743.20.00	
77 01 016 946	5741.20.00	

Originalni broj	FAD broj	Originalni broj	FAD broj
1 104 334	5323.96.00	1 769 597	6847.00.00
1 104 335	5170.96.00	1 897 333	6832.00.00
1 104 336	5587.96.00	1 897 335	6833.00.00
1 304 569	3087.00.00	1 897 673	6834.00.00
1 308 643	6839.00.00	114 406	5048.96.00
1 324 890	6842.00.00	278 665	3148.00.00
1 326 775	3084.00.00	283 783	5743.10.00
1 334 139	6830.00.00	283 784	5743.20.00
1 337 366	5810.10.00	291 396	6840.00.00
1 337 367	3581.20.00	306 981	3149.00.00
1 337 367	5810.20.00	345 124	3348.00.00
1 338 769	3083.00.00	352 645	5810.10.00
1 343 266	6835.00.00	352 646	5810.20.00
1 343 283	6838.00.00	388 943	6836.00.00
1 357 674	6832.20.00	390 784	3081.00.00
1 357 674	6852.20.00	395 009	5743.10.00
1 358 792	5743.10.00	395 010	5743.20.00
1 358 793	5743.20.00	395 350	3126.00.00
1 361 413	6832.00.00	409 639	3368.00.00
1 376 902	7523.20.00	414 531	3138.00.00
1 379 423	3343.00.00	417 290	3369.00.00
1 383 405	3089.20.00	421 573	6837.00.00
1 384 025	3082.00.00	445 599	3361.00.00
1 384 027	6847.00.00	445 626	6851.00.00
1 385 251	6833.00.00	445 629	6853.00.00
1 393 298	6841.00.00	465 816	3362.00.00
1 394 443	7981.20.00	466 801	3362.00.00
1 394 444	7982.20.00	475 463	6834.00.00
1 394 884	6849.00.00	483 527	6844.00.00
1 395 614	6832.00.00	489 987	3362.00.00
1 397 866	3126.00.00	489 989	3361.00.00
1 399 180	6831.00.00	550 806	5323.96.00
1 409 918	6833.00.00	550 808	6409.96.00
1 420 698	6843.00.00	621 863	3363.00.00
1 428 347	3083.00.00	638 860	3363.96.00
1 488 890	4126.20.00	638 861	5847.96.00
1 501 030	6833.00.00	638 862	5170.96.00
1 534 756	4126.20.00	639 287	5170.96.00
1 723 895	6833.00.00	639 370	5323.96.00
1 734 019	6832.00.00	649 346	3364.00.00
1 734 020	3126.00.00	651 156	3365.00.00
1 737 683	6833.00.00	651 157	3366.00.00
1 738 380	5743.10.00	651 158	3367.00.00
1 738 381	5743.20.00		
1 759 690	6835.00.00		
1 759 691	6838.00.00		
1 766 015	6851.00.00		
1 767 328	5743.20.00		
1 768 898	3082.00.00		

Originalni broj	FAD broj	Originalni broj	FAD broj	Originalni broj	FAD broj
1 071 344	6264.00.00	1 606 283	3074.00.00	20 443 063	6262.00.00
1 075 005	6725.00.00	1 606 284	7720.00.00	20 443 065	6266.00.00
1 075 255	5580.90.00	1 606 551	5598.00.00	20 443 067	6262.00.00
1 075 663	5141.00.00	1 607 079	5594.00.00	20 477 805	4225.00.00
1 075 664	4224.00.00	1 608 351	6750.20.00	20 490 123	5494.00.00
1 080 690	5587.00.00	1 608 352	6750.10.00	20 497 798	6261.00.00
1 080 792	6732.00.00	1 610 338	5595.00.00	20 497 799	6263.00.00
1 082 104	6758.00.00	1 611 880	4212.00.00	20 497 800	6731.00.00
1 083 744	6729.00.00	1 612 254	6746.00.00	20 502 944	6721.00.00
1 088 985	6768.00.00	1 612 781	6733.00.00	20 507 262	6720.00.00
1 094 219	4216.00.00	1 614 838	6733.00.00	20 554 908	5580.90.00
1 094 334	4219.00.00	1 626 493	6734.00.00	20 556 490	5586.00.00
1 130 567	6733.00.00	1 626 494	5136.00.00	20 556 490	6723.00.00
1 130 568	6765.00.00	1 626 637	6769.00.00	20 556 491	6761.00.00
1 134 955	5388.90.00	1 626 670	4212.00.00	20 556 492	6737.00.00
1 135 427	5597.00.00	1 626 751	5595.00.00	20 556 586	6738.00.00
1 135 427	5599.00.00	1 628 107	5586.90.00	20 739 082	6260.00.00
1 135 428	6751.00.00	1 628 483	6738.00.00	20 741 695	6720.00.00
1 135 429	6756.00.00	1 628 636	5596.00.00	20 741 703	6720.00.00
1 136 891	6751.90.00	1 629 668	4225.00.00	20 745 923	5494.00.00
1 190 778	5805.20.00	1 695 585	7720.20.00	20 994 418	6266.00.00
1 194 390	6753.00.00	1 695 776	7720.20.00	20 994 420	6262.00.00
1 197 338	5493.00.00	1 695 840	7720.10.00	21 106 930	4221.00.00
1 505 758	3546.10.00	1 697 246	4208.20.00	21 106 936	6726.00.00
1 505 759	3546.20.00	1 698 047	4208.20.00	21 252 480	6267.00.00
1 507 822	3546.10.00	1 698 190	5746.10.00	21 260 274	6727.00.00
1 507 823	3546.20.00	1 698 191	5746.20.00	21 260 275	6728.00.00
1 507 826	7720.20.00	1 698 532	3546.20.00	21 260 286	6746.00.00
1 517 439	5746.10.00	1 698 533	3546.10.00	21 308 022	5494.00.00
1 517 440	5746.20.00	1 698 557	7720.20.00	21 406 952	6268.00.00
1 517 444	5746.20.00	1 698 846	3546.20.00	271 187	5323.96.00
1 517 448	5805.10.00	1 698 847	3546.10.00	271 188	5121.90.00
1 517 449	5805.20.00	113 50 30	5597.90.00	273 373	5594.96.00
1 518 142	5805.20.00	1696 920	4746.20.00	273 375	5945.90.00
1 527 234	6762.20.00	20 367 004	6720.00.00	273 612	5386.96.00
1 573 572	6750.00.00	20 374 831	6267.00.00	273 706	5943.90.00
1 575 690	4219.00.00	20 375 555	4221.00.00	274 019	5594.96.00
1 576 092	3071.00.00	20 382 314	6721.00.00	274 056	5587.96.00
1 576 092	3074.00.00	20 390 745	6726.00.00	274 068	3744.96.00
1 576 093	7720.00.00	20 393 061	6747.00.00	274 069	5589.90.00
1 581 527	5594.00.00	20 393 063	4224.00.00	276 192	5587.96.00
1 588 263	6734.00.00	20 393 069	5141.00.00	3 039 647	4211.00.00
1 589 817	5584.00.00	20 393 071	4220.00.00	3 090 727	5596.20.00
1 591 689	5580.90.00	20 393 083	6768.00.00	3 090 728	5596.10.00
1 592 939	3075.00.00	20 393 097	6746.00.00	3 092 472	5596.20.00
1 592 940	4223.00.00	20 393 186	4221.00.00	3 093 647	4233.20.00
1 598 588	5581.90.00	20 393 187	6268.00.00	3 097 228	4222.20.00
1 605 035	6758.00.00	20 400 909	4229.00.00	3 098 294	6748.00.00
1 606 200	5587.00.00	20 400 944	6264.00.00	3 099 529	4222.20.00
1 606 277	6734.00.00	20 443 061	6266.00.00	3 110 001	5596.10.00

Originalni broj	FAD broj	Originalni broj	FAD broj
3 112 050	6261.00.00	8 158 206	5594.00.00
3 112 122	6731.00.00	8 158 207	5594.00.00
3 112 273	6263.00.00	8 190 146	4220.00.00
3 116 050	4209.00.00	8 365 399	6756.00.00
3 124 480	4229.00.00	85 104 265	6748.00.00
3 124 594	4229.00.00	85 114 144	3075.00.00
3 124 964	4208.00.00	85 114 145	4223.00.00
3 127 737	6264.00.00	85 114 197	6733.00.00
3 133 173	5524.90.00	85 114 200	5596.00.00
3 173 291	5586.00.00	9 519 278	5494.00.00
3 173 291	6723.00.00	9 523 794	6759.00.00
3 173 292	6761.00.00	9 523 795	6755.00.00
3 173 293	6737.00.00	9 959 151	6261.00.00
3 173 294	6738.00.00	9 959 152	6263.00.00
3 173 613	4218.00.00	9 959 153	6731.00.00
3 173 614	4232.00.00		
3 173 759	5580.90.00		
3 198 234	6728.00.00		
3 198 276	6727.00.00		
3 198 309	4490.96.00		
3 962 343	6769.00.00		
3 962 843	4200.00.00		
3 985 570	6746.00.00		
3 986 433	4225.00.00		
3 986 452	4221.00.00		
3 987 354	4218.00.00		
3 988 697	6747.00.00		
3 988 701	4224.00.00		
3 988 704	5141.00.00		
3 988 711	6769.00.00		
3 988 965	5596.20.00		
3 988 968	5596.10.00		
382 745	6762.20.00		
4 941 233	5594.96.00		
6 027 074	3590.20.00		
6 771 112	5140.00.00		
6 777 705	4240.00.00		
6 777 855	4229.00.00		
6 790 572	6739.00.00		
6 799 190	4208.00.00		
6 853 511	6767.00.00		
6 853 913	3590.20.00		
6 862 225	6732.00.00		
70 311 664	6260.00.00		
7420 741 703	6720.00.00		
8 132 373	4210.00.00		
8 154 016	5598.00.00		
8 154 017	5594.00.00		
8 154 444	6730.00.00		
8 156 123	6754.00.00		

**Pregled uporednih oznaka
FAD/Org. broj**

**The survey of parallel numbers
FAD/Org.nr.**

FAD broj	Originalni broj	FAD broj	Originalni broj	FAD broj	Originalni broj
3142.20.00	0 273 203	5398.00.00	1 656 428	6771.96.00	1 398 368
3142.20.00	1 399 724	5399.00.00	0 646 373	6772.00.00	0 658 104
3744.96.00	0 691 703	5399.00.00	0 655 695	6772.00.00	0 658 104
3755.90.00	0 693 778	5399.00.00	0 655 697	6773.00.00	1 257 992
3873.00.00	0 080 521	5399.00.00	1 284 860	6773.00.00	1 351 732
3873.00.00	080 521	5399.00.00	1 620 438	6773.00.00	1 385 490
3873.96.00	0 698 724	5521.96.00	0 689 748	6777.00.00	1 270 853
3873.96.00	698 724	5587.96.00	696 321	6777.00.00	1 353 391
3875.90.00	0 696 600	5594.96.00	0 513 757	6780.00.00	1 290 321
3875.90.00	696 600	5594.96.00	0 691 709	6780.00.00	1 353 394
3876.00.00	0 649 819	5741.10.00	0 607 998	6781.00.00	1 143 324
3876.00.00	0 649 819	5741.20.00	0 586 753	6781.00.00	1 191 900
3876.00.00	1 620 437	5741.20.00	0 607 999	6782.00.00	1 257 991
3876.00.00	1 793 877	5741.20.00	0 694 298	6782.00.00	1 351 718
3877.00.00	1 361 652	5741.20.00	0 694 360	6782.00.00	1 385 493
3877.00.00	1 620 436	5741.20.00	0 698 609	6783.00.00	1 315 530
3877.00.00	1 793 876	5741.20.00	1 229 944	6783.00.00	1 351 731
3879.00.00	1 291 060	5741.20.00	1 331 925	6783.00.00	1 385 506
3879.00.00	1 351 734	5742.20.00	0 069 867	6784.00.00	1 283 211
3879.00.00	1 385 499	5742.20.00	0 161 376	6784.00.00	1 351 714
3889.00.00	0 094 044	5742.20.00	0 608 000	6784.00.00	1 385 497
3889.00.00	0 274 878	5742.20.00	1 142 173	6786.00.00	1 297 572
3889.00.00	1 152 427	5743.10.00	0 607 053	6786.00.00	1 361 155
3903.20.00	1 320 855	5743.10.00	0 696 225	6787.00.00	1 363 858
3903.20.00	1 342 026	5743.10.00	1 228 115	6787.00.00	1 448 062
3957.90.00	0 693 778	5743.20.00	0 607 981	6790.10.00	ACU 9239
3965.20.00	0 516 089	5743.20.00	0 698 450	6790.20.00	ACU 9240
4233.20.00	3 093 647	5743.20.00	1 257 890	6793.00.00	1 291 048
5117.96.00	0 067 354	5743.20.00	1 257 890	6793.00.00	1 351 735
5121.90.00	0 691 704	5743.20.00	1 603 789	6793.00.00	1 385 500
5128.96.00	1 321 936	5746.10.00	0 607 452	6794.00.00	1 306 333
5170.96.00	0 689 749	5746.20.00	0 110 197	6794.00.00	1 351 741
5323.96.00	0 689 748	5746.20.00	0 607 451	6794.00.00	1 385 487
5385.00.00	0 099 990	5746.20.00	0 607 453	6795.00.00	0 589 943
5385.00.00	099 900	5746.20.00	1 228 114	6795.20.00	1 344 684
5386.00.00	0 661 406	5805.20.00	0 608 530	6796.00.00	1 395 994
5386.00.00	0 661 407	5810.20.00	0 586 714	7474.20.00	0 817 824
5387.00.00	1 261 101	5810.20.00	0 607 073	7474.20.00	817 824
5389.00.00	1 283 212	5810.20.00	0 609 634		
5389.00.00	1 351 715	5810.20.00	0 609 643		
5389.00.00	1 385 492	5810.20.00	0 696 226		
5392.00.00	0 094 038	5847.96.00	0 689 747		
5392.00.00	0 525 433	5959.90.00	1 271 124		
5393.00.00	0 094 029	6297.20.00	0 817 823		
5393.00.00	0 117 343	6409.96.00	1 243 618		
5393.00.00	94 029	6770.00.00	0 080 521		
5394.00.00	0 094 016	6770.00.00	1 368 270		
5394.00.00	0 171 215	6770.00.00	1 390 932		
5398.00.00	0 267 743	6770.00.00	1 617 096		
5398.00.00	1 361 650	6770.90.00	1 398 368		

FAD broj	Originalni broj
3581.10.00	9970 8408 376
3581.20.00	9970 8408 377
4303.20.00	9970 700 7727
4304.20.00	9970 7016 597
4305.00.00	9970 7016 595
4307.20.00	9970 7731 304
4310.00.00	9970 7016 599
4311.20.00	9970 7016 598
4314.00.00	9970 7791 455
4315.00.00	9970 7017 730
4323.00.00	9970 7060 050
4324.00.00	9970 7060 051
5741.20.00	0598 660
5899.20.00	4125 657
6100.00.00	9970 7016 596
7474.20.00	1124 113
7474.20.00	8408 188

FAD broj	Originalni broj	FAD broj	Originalni broj	FAD broj	Originalni broj
1480.20.00	9380 0662	5105.00.00	4204 1107	5144.00.00	4204 3912
1480.20.00	9380 4059	5106.00.00	4101 1006	5145.00.00	856 7618
1481.20.00	9380 2209	5106.00.00	4206 5332	5145.00.00	858 2350
1481.20.00	9380 4060	5107.00.00	4205 5474	5146.00.00	9844 6354
3203.20.00	466 3787	5108.00.00	4201 9062	5147.00.00	856 4248
3212.00.00	855 9559	5111.00.00	445 7748	5147.00.00	859 1219
3212.00.00	859 1222	5111.00.00	9319 1941	5148.00.00	857 0528
3213.00.00	856 4386	5113.00.00	4208 7842	5149.00.00	4 121 5165
3213.00.00	858 2320	5113.00.00	474 7960	5170.96.00	4248 8722
3228.20.00	9380 0662	5113.00.00	474 7961	5391.10.00	4 018 037
3228.20.00	9380 4059	5114.00.00	4212 5057	5391.10.00	4 663 791
3388.00.00	857 0528	5114.00.00	471 4134	5391.20.00	4 018 036
3393.00.00	856 5366	5114.00.00	9848 8010	5391.20.00	4 663 787
3393.00.00	858 2330	5116.00.00	471 9609	5391.90.00	6159 5957
3537.00.00	4220 0700	5117.00.00	9847 2871	5741.10.00	298 0129
3537.00.00	4220 4475	5117.96.00	9319 2361	5741.10.00	298 4511
3537.00.00	4221 1146	5118.00.00	4200 1325	5741.10.00	4249 3782
3537.00.00	4221 1148	5118.00.00	4200 1326	5741.10.00	483 3821
3559.00.00	445 7748	5118.00.00	4208 6458	5741.10.00	483 3826
3559.00.00	9319 1941	5119.00.00	4100 5463	5741.10.00	483 3828
3567.20.00	343 57 88	5119.00.00	813 1582	5741.10.00	812 2755
3567.20.00	4204 2912	5119.00.00	813 2397	5741.20.00	298 0323
3569.00.00	4102 8599	5120.00.00	0813 7026	5741.20.00	4248 3520
3569.00.00	4104 2092	5120.00.00	4100 2770	5741.20.00	4249 3781
3569.00.00	9847 2468	5120.00.00	4100 9665	5742.20.00	298 0875
3590.20.00	343 5786	5120.00.00	4102 8598	5743.10.00	298 4061
3590.20.00	798 1909	5120.00.00	4102 8600	5743.10.00	4248 9395
3590.20.00	8602 7074	5120.00.00	4103 4479	5743.10.00	4249 1957
3744.96.00	9319 2618	5120.00.00	4104 2050	5743.10.00	480 2444
3765.96.00	4249 3431	5120.90.00	9316 1631	5743.10.00	483 3830
3765.96.00	9319 2619	5120.90.00	9316 1638	5743.10.00	819 0225
4569.96.00	500 333 284	5121.00.00	471 6271	5743.20.00	296 6252
4671.00.00	5003 977 38	5121.90.00	296 8454	5743.20.00	296 9808
4746.20.00	4248 7165	5122.00.00	477 3359	5743.20.00	4248 3386
4746.20.00	855 8527	5122.00.00	483 4037	5743.20.00	4248 8269
4746.20.00	9319 4626	5122.10.00	486 8942	5743.20.00	4248 9573
5081.00.00	4212 5057	5122.10.00	858 2333	5743.20.00	4248 9594
5081.00.00	471 4134	5122.20.00	468 8941	5743.20.00	4249 1638
5087.00.00	858 7018	5122.20.00	716 7757	5743.20.00	480 2443
5094.00.00	248 3652	5122.20.00	856 5366	5743.20.00	483 3829
5094.00.00	252 0334	5122.20.00	858 2332	5743.20.00	812 2752
5094.00.00	4203 2936	5123.00.00	485 4874	5746.10.00	296 9507
5095.00.00	252 0336	5124.00.00	9840 2544	5746.10.00	4248 4887
5095.00.00	4203 2938	5124.00.00	9846 7459	5746.10.00	483 3826
5096.00.00	4204 2431	5126.00.00	471 6799	5746.10.00	812 3394
5097.00.00	4200 0486	5128.96.00	9316 3617	5746.10.00	855 8536
5097.00.00	4203 4051	5142.00.00	855 8522	5746.20.00	296 6321
5103.00.00	9848 8010	5143.00.00	471 1108	5746.20.00	296 6635
5104.00.00	4200 0481	5143.00.00	471 1109	5746.20.00	4248 4886
5104.00.00	4203 4054	5144.00.00	4204 2950	5746.20.00	483 3825

FAD broj	Originalni broj	FAD broj	Originalni broj
5746.20.00	819 3645	6423.00.00	4 121 5165
5746.20.00	855 8533	6424.00.00	4 103 2608
5746.20.00	858 2322	6424.00.00	4 103 3237
5805.10.00	4248 0023	6425.20.00	4253 3101
5805.10.00	4253 2543	6425.20.00	4253 3102
5805.10.00	819 3649	6426.20.00	9319 2809
5805.20.00	4248 0024	6427.00.00	9847 5709
5805.20.00	4249 1937	6428.00.00	9849 3054
5856.10.00	468 8949	6429.00.00	5 0032 4282
5856.20.00	468 8948	6430.00.00	4102 8269
5959.90.00	298 0884	6430.00.00	4129 8449
6341.00.00	9710 4299	6432.20.00	4100 2118
6342.00.00	9847 2466	6432.20.00	4120 3863
6344.00.00	9944 4744	6432.20.00	4204 1327
6359.00.00	4203 7386	6432.20.00	4207 9853
6359.00.00	8601 2923	6433.00.00	5003 360 85
6363.00.00	8 601 1651	7474.20.00	0928 1792
6364.00.00	247 5843	7474.20.00	928 1792
6364.00.00	4201 4656		
6364.00.00	4202 6837		
6364.00.00	4202 6840		
6364.00.00	4203 7655		
6364.00.00	4203 7657		
6383.00.00	9847 0968		
6395.00.00	9848 4091		
6397.00.00	4208 8124		
6397.00.00	472 0262		
6398.00.00	4100 5466		
6398.00.00	4101 6964		
6399.00.00	474 1171		
6402.00.00	5 0030 7556		
6402.00.00	9840 2553		
6403.00.00	4200 3432		
6404.00.00	485 4871		
6405.00.00	4100 5309		
6405.00.00	4100 5460		
6405.00.00	816 5309		
6414.00.00	4100 5469		
6414.00.00	4101 1476		
6414.00.00	4101 6960		
6414.00.00	4101 6961		
6414.00.00	813 5492		
6415.00.00	4121 4657		
6417.00.00	9844 9025		
6417.00.00	9846 9650		
6418.00.00	4103 6943		
6420.00.00	9847 3328		
6422.00.00	4100 5475		
6422.00.00	4100 6093		

FAD/KÄSSBOHRER



FAD broj	Originalni broj	FAD broj	Originalni broj
3491.00.00	8.226.232.000	5743.20.00	6.851.531.000
3491.00.00	8.226.241.000	5743.20.00	8.226.236.059
3491.00.00	8.226.357.000	6042.00.00	8.226.257.000
3492.00.00	8.226.306.000	6043.00.00	8.226.261.000 C
3492.00.00	8.226.244.000 D	6044.00.00	8.226.294.000
3492.00.00	8.226.258.000 C	6045.00.00	8.226.225.000 D
3493.00.00	8.226.137.000	6048.00.00	8.226.238.000 C
3493.00.00	8.226.147.000 C	6049.00.00	8.226.307.000
3493.00.00	8.226.305.000 C	6049.00.00	8.226.347.000
3493.00.00	8.226.313.000 C	6049.00.00	8.226.247.000 C
3494.00.00	8.226.259.000	6197.00.00	6.293.500.606
3494.00.00	8.226.262.000	6197.00.00	8.226.293.000B
3494.00.00	8.226.259.000 C		
3494.00.00	8.226.262.000 C		
3497.00.00	8.226.318.000 B		
3497.00.00	8.226.323.000 B		
3581.10.00	6.851.490.000		
3581.20.00	6.851.491.000		
3590.20.00	8.321.999.319		
4911.00.00	8.226.308.000		
4911.00.00	8.226.381.000		
4911.00.00	8.226.248.000 C		
4911.00.00	8.226.308.000 C		
4911.20.00	68.515.290.000		
4912.00.00	8.226.328.000		
4913.00.00	8.226.356.000		
4914.00.00	8.226.380.000		
4914.00.00	8.226.380.000 C		
4914.00.00	8.226.380.000.0		
4915.00.00	8.226.330.000		
5170.96.00	82 262 320 660		
5687.00.00	8.226.138.000		
5687.00.00	8.226.148.000 C		
5741.20.00	6.851.517.000		
5742.10.00	6.851.446.000		
5742.10.00	6.851.459.000		
5742.10.00	6.851.479.000		
5742.10.00	6.851.487.000		
5742.10.00	6.851.532.000		
5742.20.00	6.851.447.000		
5742.20.00	6.851.478.000		
5742.20.00	6.851.486.000		
5742.20.00	6.851.488.000		
5742.20.00	6.851.523.000		
5743.10.00	6.851.485.000		
5743.10.00	8.226.236.058		
5743.20.00	6.851.475.000		
5743.20.00	6.851.480.000		
5743.20.00	6.851.484.000		

FAD broj	Originalni broj
3903.20.00	10220897
4484.96.00	5211 543
4484.96.00	5211 543 08
5743.10.00	5718 665 08
5743.20.00	5718 666 08
6027.00.00	5211 435 08
6027.10.00	5708 161 08
6027.20.00	5708 160 08
6100.00.00	5211 439
6101.00.00	5211 440 08
6102.00.00	5211 441
6102.00.00	5211 441 08
6103.00.00	5211 448
6103.00.00	5211 448 08
6104.10.00	5708 197 08
6104.20.00	5708 196 08
6105.00.00	5211 434
6105.00.00	5211 434 08
6106.00.00	5211 438
6106.00.00	5211 438 08
6106.10.00	5708 159 08
6106.20.00	5708 158 08
7474.20.00	7250 510
7474.20.00	7250 510 08

FAD broj	Originalni broj	FAD broj	Originalni broj	FAD broj	Originalni broj
3500.90.00	81.43270.6047	4119.00.00	81.46711.6719	4148.00.00	81.46711.6802
3581.20.00	81.95301.0022	4119.00.00	81.46711.6729	4148.00.00	81.46711.6804
3581.20.00	81.95301.6297	4123.00.00	81.46710.6453	4148.00.00	81.46711.6808
3590.20.00	81.95301.0038	4123.00.00	81.46710.6457	4148.00.00	81.46711.6891
3590.20.00	81.95301.0045	4123.00.00	81.46710.6458	4148.00.00	81.46711.6892
3590.20.00	81.95301.6016	4123.00.00	81.46710.6875	4148.00.00	81.46711.6895
3590.20.00	81.95301.6169	4123.00.00	81.46710.6881	4149.00.00	85.46610.6018
3590.20.00	81.95301.6172	4123.00.00	81.46711.6765	4149.00.00	85.46610.6118
3590.20.00	81.95301.6176	4123.00.00	81.46711.6766	4149.00.00	85.46610.6152
3698.00.00	81.43230.6037	4123.00.00	81.46711.6767	4149.00.00	85.46610.6218
3698.90.00	81.43230.6043	4126.20.00	81.95301.6286	4151.00.00	85.43270.6001
3765.96.00	81.43270.6040	4130.00.00	81.43250.6014	4152.00.00	81.46610.6281
3765.96.00	81.43270.6045	4131.00.00	81.46611.6199	4152.00.00	81.46610.6300
3776.00.00	81.46710.6176	4131.00.00	81.46611.6200	4152.00.00	81.46610.6303
3776.00.00	81.46710.6340	4132.00.00	81.46711.6711	4152.00.00	81.46610.6304
3776.00.00	81.46710.6344	4133.00.00	81.46710.6966	4152.00.00	81.46610.6327
3776.00.00	81.46710.6422	4133.00.00	81.46711.6714	4152.00.00	81.46610.6329
3777.00.00	81.46710.6175	4134.00.00	81.46710.6122	4492.96.00	81.43270.6105
3777.00.00	81.46710.6242	4134.00.00	81.46710.6167	4569.96.00	85.43220.6002
3777.00.00	81.46710.6251	4134.00.00	81.46710.6194	5117.96.00	81.43230.6061
3777.00.00	81.46710.6251	4134.00.00	81.46710.6195	5170.96.00	81.43220.6055
3777.00.00	81.46710.6420	4134.00.00	81.46710.6378	5170.96.00	81.43220.6073
4094.00.00	81.46710.6918	4134.00.00	81.46710.6379	5210.00.00	81.46710.6236
4094.00.00	81.46711.6740	4134.00.00	81.46710.6380	5210.00.00	81.46710.6267
4104.00.00	81.46710.6117	4134.00.00	81.46710.6830	5210.00.00	81.46710.6268
4104.00.00	81.46710.6281	4134.00.00	81.46710.6836	5210.00.00	81.46710.6355
4104.00.00	81.46710.6282	4134.00.00	81.46710.6912	5210.00.00	81.46710.6356
4104.00.00	81.46710.6370	4134.00.00	81.46711.6736	5210.00.00	81.46710.6373
4104.00.00	81.46710.6371	4135.00.00	81.46711.6860	5210.00.00	81.46711.6723
4104.00.00	81.46710.6372	4135.00.00	81.46711.6861	5215.00.00	81.46710.6388
4107.00.00	81.43220.6189	4135.00.00	81.46711.6921	5215.00.00	81.46710.6393
4108.00.00	81.43220.6161	4136.00.00	81.46610.6790	5216.00.00	81.46710.6112
4108.00.00	81.43220.6190	4136.00.00	81.46610.6791	5216.00.00	81.46710.6163
4109.20.00	81.95301.6219	4136.00.00	82.46610.6191	5216.00.00	81.46710.6165
4109.20.00	81.95301.6225	4137.00.00	81.43250.6011	5216.00.00	81.46710.6198
4109.20.00	81.95301.6226	4137.00.00	81.43250.6016	5216.00.00	81.46710.6353
4109.20.00	81.95301.6267	4138.00.00	85.46610.6108	5216.00.00	81.46710.6354
4109.20.00	81.95301.6291	4138.00.00	85.46610.6144	5216.00.00	81.46710.6361
4115.00.00	81.46610.6725	4138.00.00	85.46610.6208	5216.00.00	81.46711.6725
4115.00.00	85.46610.6030	4141.00.00	85.46610.6105	5216.00.00	81.46711.6820
4115.00.00	85.46610.6102	4141.00.00	85.46610.6141	5219.00.00	81.46610.6159
4115.00.00	85.46610.6201	4143.00.00	85.46610.6107	5219.00.00	81.46610.6200
4116.00.00	81.46610.6753	4143.00.00	85.46610.6143	5219.00.00	81.46611.6064
4116.00.00	81.46610.6754	4145.00.00	81.46610.6578	5219.00.00	81.46710.6319
4116.00.00	85.46610.6104	4145.00.00	81.46610.6798	5235.00.00	81.46610.6424
4117.00.00	85.46610.6021	4145.00.00	81.46610.6876	5235.00.00	81.46610.6432
4117.00.00	85.46610.6121	4146.00.00	85.46610.6012	5235.00.00	81.46610.6434
4117.00.00	85.46610.6140	4146.00.00	85.46610.6112	5235.00.00	81.46610.6437
4119.00.00	81.46710.6851	4146.00.00	85.46610.6142	5235.00.00	81.46610.6513
4119.00.00	81.46710.6852	4146.00.00	85.46610.6212	5235.00.00	81.46610.6537

FAD broj	Originalni broj	FAD broj	Originalni broj	FAD broj	Originalni broj
5235.00.00	81.46610.6596	5546.00.00	81.43220.6129	5743.20.00	81.95301.6143
5235.00.00	81.46610.6614	5546.00.00	81.43230.6014	5743.20.00	81.95301.6149
5235.00.00	81.46610.6635	5546.00.00	81.43230.6030	5743.20.00	81.95301.6154
5235.00.00	81.46610.6735	5554.00.00	81.43250.6007	5743.20.00	81.95301.6156
5235.00.00	81.46610.6743	5564.00.00	81.46710.6131	5743.20.00	81.95301.6178
5245.00.00	81.46710.6238	5564.00.00	81.46710.6265	5743.20.00	81.95301.6194
5245.00.00	81.46710.6240	5564.00.00	81.46710.6266	5743.20.00	81.95301.6224
5245.00.00	81.46710.6409	5564.00.00	81.46710.6359	5743.20.00	81.95301.6234
5245.00.00	81.46710.6410	5564.00.00	81.46710.6360	5743.20.00	81.95301.6274
5259.00.00	81.46610.6656	5564.00.00	81.46710.6362	5743.20.00	81.95301.6278
5259.00.00	81.46610.6659	5564.00.00	81.46710.6396	5746.10.00	81.95301.0079
5259.00.00	81.46611.6006	5564.00.00	81.46710.6397	5746.10.00	81.95301.6139
5323.96.00	81.43230.6051	5564.00.00	81.46710.6816	5746.10.00	81.95301.6222
5323.96.00	81.43230.6068	5564.00.00	81.46710.6904	5746.20.00	81.95301.6060
5323.96.00	81.43270.6064	5564.00.00	81.46711.6724	5746.20.00	81.95301.6135
5332.00.00	81.46710.6865	5587.96.00	81.43270.6079	5746.20.00	81.95301.6140
5332.00.00	81.46710.6866	5594.96.00	81.43220.6203	5746.20.00	81.95301.6249
5332.00.00	81.46711.6728	5741.10.00	81.95301.0013	5805.10.00	81.95301.0078
5333.00.00	81.46710.6434	5741.10.00	81.95301.0074	5805.10.00	81.95301.6141
5333.00.00	81.46710.6435	5741.10.00	81.95301.6068	5805.10.00	81.95301.6304
5333.00.00	81.46710.6456	5741.10.00	81.95301.6163	5805.10.00	81.95301.6322
5335.00.00	81.46610.6129	5741.10.00	90.80415.3107	5805.20.00	81.95301.0077
5336.20.00	81.95301.0040	5741.10.00	90.80415.3113	5805.20.00	81.95301.6134
5337.20.00	81.95301.0041	5742.10.00	81.95301.6070	5805.20.00	81.95301.6142
5339.00.00	81.43220.6168	5742.10.00	81.95301.6261	5805.20.00	81.95301.6321
5520.00.00	81.46610.6088	5742.20.00	81.95301.0025	5810.20.00	81.95301.0022
5522.00.00	81.43718.6006	5742.20.00	90.80415.4117	5856.20.00	81.95301.6184
5522.00.00	81.43718.6007	5743.10.00	81.95301.0015	5910.00.00	81.43220.6010
5522.96.00	81.43718.6009	5743.10.00	81.95301.0083	5910.00.00	81.43220.6012
5524.90.00	81.43270.6065	5743.10.00	81.95301.0097	5910.00.00	81.43220.6013
5531.96.00	81.43220.6053	5743.10.00	81.95301.6030	5910.00.00	81.43220.6020
5532.00.00	81.46610.6414	5743.10.00	81.95301.6043	5910.00.00	81.43220.6028
5535.00.00	81.43315.6012	5743.10.00	81.95301.6050	5910.00.00	81.43220.6035
5535.96.00	81.95302.0039	5743.10.00	81.95301.6054	5910.00.00	81.43220.6040
5536.00.00	81.46610.6360	5743.10.00	81.95301.6087	5910.00.00	81.43220.6041
5536.00.00	81.46610.6361	5743.10.00	81.95301.6091	5910.00.00	81.43220.6052
5536.00.00	81.46610.6721	5743.10.00	81.95301.6155	5910.00.00	81.43220.6056
5536.00.00	81.46610.6721	5743.10.00	81.95301.6168	5910.00.00	81.43230.6018
5536.00.00	81.46610.6722	5743.10.00	81.95301.6179	5921.00.00	81.43220.6096
5536.00.00	81.46610.6723	5743.10.00	81.95301.6237	5921.00.00	81.43220.6097
5536.20.00	81.95301.6263	5743.10.00	81.95301.6279	5921.00.00	81.43220.6098
5537.00.00	81.43230.6037	5743.20.00	81.95301.0016	5921.00.00	81.43220.6129
5538.00.00	81.43220.6102	5743.20.00	81.95301.0084	5921.00.00	81.43230.6014
5538.00.00	81.43220.6148	5743.20.00	81.95301.6048	5921.00.00	81.43230.6030
5538.00.00	81.43220.6152	5743.20.00	81.95301.6049	5922.00.00	81.43230.6038
5538.00.00	81.43220.6186	5743.20.00	81.95301.6053	5922.00.00	81.43230.6039
5539.00.00	81.46610.6089	5743.20.00	81.95301.6090	5932.00.00	81.46610.6196
5546.00.00	81.43220.6096	5743.20.00	81.95301.6108	5932.00.00	81.46610.6202
5546.00.00	81.43220.6097	5743.20.00	81.95301.6112	5932.00.00	81.46610.6409
5546.00.00	81.43220.6098	5743.20.00	81.95301.6126	5932.00.00	81.46610.6504

FAD broj	Originalni broj	FAD broj	Originalni broj	FAD broj	Originalni broj
5932.00.00	81.46610.6531	5943.00.00	81.43270.6078	6179.00.00	81.46710.6054
5932.00.00	81.46610.6593	5943.00.00	81.43270.6082	6179.00.00	81.46710.6059
5932.00.00	81.46610.6609	5943.00.00	81.43270.9034	6179.00.00	81.46710.6145
5932.00.00	81.46610.6631	5943.00.00	81.43270.9078	6179.00.00	81.46710.6302
5932.00.00	81.46610.6740	5943.90.00	81.95301.6132	6181.00.00	81.43220.6129
5933.00.00	81.46710.6080	5944.00.00	81.43270.6056	6186.00.00	81.43220.6140
5933.00.00	81.46710.6136	5944.00.00	81.43270.6067	6186.00.00	81.43220.9140
5933.00.00	81.46710.6172	5944.00.00	81.43270.6075	6188.00.00	81.43220.6236
5933.00.00	81.46710.6295	5944.00.00	81.43270.6077	6188.00.00	81.43220.6267
5933.00.00	81.46710.6337	5944.00.00	81.43270.6081	6188.00.00	81.43220.6272
5933.00.00	81.46710.6345	5944.00.00	81.43270.9056	6189.00.00	81.43270.6096
5933.00.00	81.46710.6421	5944.96.00	81.43270.6105	6191.00.00	81.43220.6174
5933.00.00	81.46710.6451	5945.90.00	81.95301.6133	6196.00.00	81.46611.6096
5933.00.00	81.46710.6876	5946.00.00	81.46610.6147	6198.00.00	81.46610.6708
5934.00.00	81.46710.6081	5946.00.00	81.46610.6195	6198.00.00	81.46611.6067
5934.00.00	81.46710.6137	5946.00.00	81.46610.6201	6201.00.00	81.43220.6247
5934.00.00	81.46710.6173	5946.00.00	81.46610.6257	6202.00.00	81.46610.6716
5934.00.00	81.46710.6294	5946.00.00	81.46610.6415	6202.00.00	81.46611.6068
5934.00.00	81.46710.6419	5946.00.00	81.46610.6476	6203.00.00	81.46610.6689
5934.00.00	81.46710.6444	5946.00.00	81.46610.6503	6203.00.00	81.46610.6720
5934.00.00	81.46710.6877	5946.00.00	81.46610.6532	6206.00.00	81.46610.6376
5934.00.00	81.46710.6879	5946.00.00	81.46610.6594	6207.00.00	81.46710.6443
5934.00.00	81.46711.6759	5946.00.00	81.46610.6608	6211.00.00	81.46610.6756
5934.00.00	81.46711.6760	5946.00.00	81.46610.6630	6212.00.00	81.46610.6779
5934.00.00	81.46711.6761	5948.00.00	81.43220.6025	6212.00.00	81.46610.6780
5937.00.00	81.43220.6096	5950.00.00	81.43220.6067	6212.00.00	81.46610.6782
5937.00.00	81.43220.6097	5950.00.00	81.43220.6068	6213.00.00	81.46710.6436
5937.00.00	81.43220.6098	5950.00.00	81.43220.6090	6214.00.00	81.46710.6438
5937.00.00	81.43220.6129	5950.00.00	81.43220.6092	6214.00.00	81.46710.6439
5937.00.00	81.43230.6014	5950.00.00	81.43220.9092	6215.00.00	81.46710.6994
5937.00.00	81.43230.6030	5951.00.00	81.43220.6042	6215.00.00	81.46711.6726
5938.00.00	81.43220.6070	5952.00.00	81.43220.6043	6216.00.00	81.46611.6197
5938.00.00	81.43220.6071	5956.00.00	81.43220.6099	6216.00.00	81.46611.6198
5938.00.00	81.43220.6072	5956.00.00	81.43220.6100	6218.00.00	81.46711.6773
5938.00.00	81.43220.6091	5959.00.00	81.43220.6096	6218.00.00	81.46711.6858
5938.00.00	81.43220.6093	5959.00.00	81.43220.6097	6219.00.00	81.43270.6117
5940.00.00	81.43230.6015	5959.00.00	81.43220.6098	6221.00.00	81.46610.6643
5940.00.00	81.43230.6031	5959.00.00	81.43220.6129	6222.00.00	81.46710.6418
5940.00.00	81.43230.9031	5959.00.00	81.43230.6014	6223.00.00	81.46611.6133
5941.00.00	81.43220.6096	5959.00.00	81.43230.6030	6224.00.00	81.46611.6004
5941.00.00	81.43220.6097	5959.90.00	81.43220.6108	6224.00.00	81.46611.6005
5941.00.00	81.43220.6098	5975.00.00	81.46610.6374	6224.00.00	81.46611.6005
5941.00.00	81.43220.6129	5975.00.00	81.46611.6019	6233.00.00	81.46611.6133
5941.00.00	81.43230.6014	5976.00.00	81.46710.6459	6425.20.00	81.95301.6219
5941.00.00	81.43230.6030	5976.00.00	81.46710.6818	6425.20.00	81.95301.6225
5943.00.00	81.43270.6030	5976.00.00	81.46710.6908	6425.20.00	81.95301.6226
5943.00.00	81.43270.6034	5977.00.00	81.46710.6459	6425.20.00	81.95301.6267
5943.00.00	81.43270.6057	6173.00.00	81.43220.6106	6425.20.00	81.95301.6291
5943.00.00	81.43270.6074	6173.00.00	81.43230.6049	6791.00.00	81.46711.6715
5943.00.00	81.43270.6076	6179.00.00	81.46710.6037	6791.00.00	81.46711.6823

FAD broj	Originalni broj	
6792.00.00	81.46710.6862	
6792.00.00	81.46710.6863	
6792.00.00	81.46710.6864	
6792.00.00	81.46710.6909	
6792.00.00	81.46710.6910	
6792.00.00	81.46710.6974	
6792.00.00	81.46711.6712	
6792.00.00	81.46711.6786	
7474.20.00	82.95301.0011	
7685.00.00	81.46610.6767	
7685.00.00	81.46610.6768	
7685.00.00	81.46611.6014	

FAD broj	Originalni broj	FAD broj	Originalni broj	FAD broj	Originalni broj
1074.20.00	000 460 72 48	3431.00.00	383 330 03 11	3692.00.00	309 330 17 03
1074.20.00	001 330 48 35	3431.00.00	654 330 00 11	3692.00.00	309 330 18 03
1074.20.00	460 330 12 35	3431.00.00	654 330 01 11	3692.00.00	309 330 19 03
1701.10.00	000 338 08 10	3432.00.00	653 330 00 11	3692.00.00	309 330 20 03
1701.10.00	000 338 20 10	3433.00.00	620 330 02 11	3692.00.00	309 330 21 03
1701.10.00	000 338 50 10	3434.00.00	655 330 00 11	3692.10.00	000 330 26 35
1701.10.00	000 338 53 10	3435.00.00	620 330 03 11	3692.10.00	000 330 69 35
1701.20.00	000 338 54 10	3444.00.00	357 330 02 03	3692.10.00	001 330 08 35
1702.00.00	124 330 08 03	3444.00.00	357 330 04 03	3692.10.00	001 330 10 35
1702.20.00	000 338 51 10	3444.00.00	357 330 05 03	3692.20.00	000 330 27 35
1703.00.00	631 330 03 03	3471.00.00	395 350 05 06	3692.20.00	000 330 70 35
1703.10.00	631 330 04 10	3492.00.00	634 460 05 05	3692.20.00	001 330 07 35
1703.20.00	631 338 03 10	3500.90.00	000 350 01 05	3692.20.00	001 330 09 35
1704.00.00	631 330 05 03	3500.95.00	000 586 19 33	3693.00.00	363 460 00 05
1704.00.00	631 330 07 03	3503.00.00	383 350 01 05	3697.00.00	381 350 03 06
1704.20.00	631 330 04 35	3503.00.00	393 350 52 05	3697.00.00	385 350 02 06
1705.00.00	631 330 04 03	3503.00.00	393 350 53 05	3699.00.00	625 350 01 06
1706.00.00	631 330 06 03	3503.00.00	393 350 54 05	3708.00.00	619 460 25 05
1708.00.00	608 330 04 03	3503.00.00	393 350 55 05	3708.00.00	619 460 29 05
1711.20.00	901 460 01 48	3503.00.00	653 350 01 05	3708.00.00	619 460 52 05
1711.20.00	901 460 03 48	3503.00.00	653 353 00 05	3713.10.00	000 330 33 35
1715.10.00	000 338 43 10	3503.00.00	655 350 03 05	3713.20.00	000 330 14 35
1715.10.00	000 338 45 10	3503.00.00	658 350 00 05	3716.00.00	391 330 04 03
1715.10.00	000 338 60 10	3581.20.00	000 460 17 48	3716.00.00	391 330 07 03
1715.10.00	000 338 62 10	3590.20.00	000 268 01 81	3716.00.00	391 330 09 03
1715.20.00	000 338 42 10	3590.20.00	000 268 48 89	3716.00.00	391 330 11 03
1715.20.00	000 338 44 10	3590.20.00	000 268 52 89	3720.00.00	387 460 00 05
1715.20.00	000 338 61 10	3601.38.00	322 330 10 11	3722.00.00	389 330 01 03
3301.00.00	945 330 00 07	3601.38.00	357 330 31 11	3723.00.00	352 460 37 05
3302.00.00	000 360 098 524	3602.38.00	317 350 07 06	3723.00.00	352 460 66 05
3302.00.00	000 390 098 524	3602.38.00	600 330 01 11	3723.00.00	352 460 71 05
3302.00.00	941 330 00 11	3604.38.00	317 350 06 06	3724.00.00	365 460 06 05
3302.00.00	SA 508 316 / 01	3604.38.00	357 330 34 11	3725.00.00	366 460 07 05
3303.00.00	941 330 00 07	3605.38.00	301 330 00 11	3726.00.00	366 460 08 05
3304.00.00	945 330 00 11	3605.38.00	600 330 00 11	3728.00.00	335 460 05 05
3304.00.00	SA 508 316 / 02	3608.38.00	317 330 02 11	3728.00.00	335 460 07 05
3305.00.00	355 460 15 05	3609.38.00	317 330 04 11	3728.00.00	335 460 08 05
3305.00.00	355 460 59 05	3609.38.00	357 330 42 11	3730.00.00	346 330 45 03
3305.00.00	355 460 60 05	3690.00.00	395 350 10 06	3730.00.00	346 330 51 03
3306.00.00	675 460 10 05	3690.00.00	624 350 02 06	3733.00.00	352 460 35 05
3306.00.00	675 460 16 05	3690.00.00	659 350 13 06	3734.00.00	302 330 01 03
3306.00.00	675 460 22 05	3690.00.00	659 350 36 06	3734.00.00	302 330 04 03
3306.00.00	675 460 28 05	3691.00.00	395 350 13 06	3734.00.00	302 330 07 03
3307.00.00	676 460 01 05	3691.00.00	624 350 05 06	3735.00.00	302 330 03 03
3307.00.00	676 460 06 05	3691.00.00	659 350 16 06	3735.00.00	302 330 06 03
3307.00.00	676 460 11 05	3691.00.00	659 350 39 06	3735.00.00	302 330 18 03
3307.00.00	676 460 15 05	3692.00.00	309 330 12 03	3736.00.00	352 460 10 05
3310.00.00	307 330 01 11	3692.00.00	309 330 13 03	3736.00.00	352 460 19 05
3310.00.00	357 330 36 11	3692.00.00	309 330 14 03	3736.00.00	352 460 27 05
3310.96.00	000 330 00 75	3692.00.00	309 330 16 03	3736.00.00	352 460 44 05

FAD broj	Originalni broj	FAD broj	Originalni broj	FAD broj	Originalni broj
3736.00.00	352 460 54 05	3765.00.00	395 350 00 06	3938.00.00	620 460 41 05
3738.00.00	358 330 01 03	3765.00.00	624 350 00 06	3950.90.00	000 350 14 05
3738.00.00	358 330 05 03	3765.00.00	659 350 11 06	3952.00.00	357 330 17 11
3738.00.00	381 330 03 03	3765.00.00	659 350 34 06	3956.90.00	000 350 02 05
3738.00.00	381 330 05 03	3765.96.00	000 350 04 13	3957.90.00	000 350 02 13
3738.00.00	381 330 06 03	3765.96.00	000 586 12 35	3957.90.00	000 350 03 05
3738.00.00	381 330 07 03	3767.00.00	395 350 11 06	3957.90.00	000 350 05 05
3739.00.00	346 330 5003	3767.00.00	395 350 12 06	3957.90.00	000 586 14 33
3742.00.00	393 320 01 32	3767.00.00	659 350 09 06	3958.00.00	396 460 30 05
3742.00.00	655 350 00 06	3767.00.00	659 350 32 06	3958.00.00	396 460 48 05
3742.00.00	658 350 00 06	3768.00.00	624 350 04 06	3959.00.00	396 460 31 05
3742.00.00	658 350 02 06	3768.00.00	659 350 15 06	3959.00.00	396 460 49 05
3744.00.00	395 350 02 06	3768.00.00	659 350 38 06	3965.20.00	440 460 03 48
3744.00.00	659 350 01 06	3769.00.00	395 350 13 06	3965.20.00	440 460 05 48
3744.00.00	659 350 24 06	3769.00.00	624 350 05 06	3967.00.00	357 460 14 05
3744.96.00	000 350 06 13	3769.00.00	659 350 16 06	3967.00.00	357 460 15 05
3744.96.00	000 586 11 35	3769.00.00	659 350 39 06	3968.00.00	385 330 02 03
3745.00.00	395 350 07 06	3769.96.00	000 350 01 13	3968.00.00	385 330 08 03
3745.00.00	659 350 04 06	3914.00.00	352 460 23 05	3968.00.00	385 330 16 03
3745.00.00	659 350 27 06	3914.00.00	352 460 31 05	3968.00.00	385 330 18 03
3751.00.00	385 350 01 06	3914.00.00	352 460 32 05	3969.00.00	617 460 24 05
3751.00.00	395 320 03 32	3914.00.00	352 460 48 05	3969.00.00	617 460 34 05
3752.00.00	395 320 01 32	3914.00.00	352 460 49 05	3971.00.00	620 460 04 05
3753.00.00	393 320 02 32	3914.00.00	352 460 56 05	3971.00.00	620 460 08 05
3754.00.00	393 320 04 32	3916.00.00	668 460 05 05	3971.00.00	620 460 29 05
3755.00.00	395 320 14 32	3916.00.00	668 460 07 05	3971.00.00	620 460 30 05
3755.90.00	000 350 02 13	3916.00.00	668 460 09 05	3972.00.00	675 460 12 05
3755.90.00	000 350 03 05	3916.00.00	668 460 11 05	3972.00.00	675 460 18 05
3755.90.00	000 350 05 05	3917.00.00	668 460 15 05	3972.00.00	675 460 24 05
3755.90.00	000 586 14 33	3917.00.00	668 460 17 05	3972.00.00	675 460 30 05
3755.95.00	000 586 15 33	3917.00.00	668 460 19 05	3973.00.00	001 460 29 05
3756.00.00	343 320 16 32	3918.00.00	313 460 01 05	3973.00.00	001 460 30 05
3756.00.00	343 320 17 32	3919.00.00	355 460 09 05	3974.00.00	625 330 15 03
3756.00.00	343 320 18 32	3919.00.00	355 460 35 05	3974.00.00	625 330 16 03
3757.00.00	352 350 04 06	3919.00.00	355 460 51 05	3974.00.00	625 330 24 03
3757.90.00	000 586 01 32	3922.00.00	352 460 28 05	3974.00.00	625 330 25 03
3757.95.00	000 586 07 32	3922.00.00	352 460 57 05	3975.00.00	622 460 04 05
3758.00.00	393 320 03 32	3923.00.00	625 460 44 05	3975.00.00	622 460 14 05
3759.00.00	624 350 01 06	3924.00.00	602 330 09 03	3975.00.00	622 460 15 05
3759.00.00	659 350 12 06	3924.00.00	602 330 10 03	3976.00.00	622 460 02 05
3759.00.00	659 350 35 06	3924.00.00	602 330 53 03	3976.00.00	622 460 03 05
3760.00.00	659 350 17 06	3924.00.00	602 330 54 03	3976.00.00	622 460 09 05
3761.00.00	624 350 03 06	3935.96.00	000 330 14 11	3976.00.00	622 460 10 05
3761.00.00	659 350 14 06	3936.96.00	000 350 21 05	3977.00.00	625 330 26 03
3761.00.00	659 350 37 06	3937.00.00	625 330 09 03	3977.00.00	625 330 27 03
3762.00.00	395 350 11 06	3937.00.00	625 330 12 03	3978.00.00	617 330 02 03
3762.00.00	395 350 12 06	3937.00.00	944 330 02 03	3978.00.00	617 330 03 03
3762.00.00	659 350 09 06	3938.00.00	620 460 24 05	3979.00.00	947 350 00 05
3762.00.00	659 350 32 06	3938.00.00	620 460 26 05	3979.00.00	948 350 06 05
3764.00.00	395 350 08 06	3938.00.00	620 460 40 05	3979.00.00	948 350 12 05

FAD broj	Originalni broj	FAD broj	Originalni broj	FAD broj	Originalni broj
3979.00.00	948 350 13 05	4480.00.00	944 350 00 05	4526.00.00	355 460 23 05
3987.00.00	391 460 09 05	4480.00.00	947 350 01 05	4526.00.00	355 460 28 05
3987.00.00	391 460 17 05	4480.00.00	947 350 10 05	4526.00.00	355 460 47 05
3987.00.00	391 460 18 05	4482.96.00	000 350 22 05	4527.00.00	002 460 47 05
3988.00.00	619 460 04 05	4483.96.00	000 350 23 05	4527.00.00	002 460 48 05
3988.00.00	619 460 19 05	4484.96.00	000 350 24 05	4528.00.00	000 460 95 05
3988.00.00	619 460 45 05	4488.00.00	357 333 06 05	4528.00.00	001 460 71 05
3991.00.00	343 320 16 32	4488.00.00	357 333 09 05	4529.00.00	000 460 71 05
3991.00.00	343 320 17 32	4489.10.00	000 460 84 48	4529.00.00	000 460 72 05
3991.00.00	343 320 18 32	4489.10.00	001 460 07 48	4529.00.00	001 460 67 05
3991.90.00	343 586 00 32	4489.20.00	000 460 48 48	4531.00.00	000 460 98 05
3991.95.00	000 586 06 32	4489.20.00	001 460 06 48	4531.00.00	000 460 99 05
3992.00.00	343 320 16 32	4490.96.00	000 350 29 05	4532.00.00	972 460 14 05
3992.00.00	343 320 17 32	4492.96.00	000 350 28 05	4532.00.00	972 460 16 05
3992.00.00	343 320 18 32	4495.00.00	000 460 92 05	4533.00.00	001 460 03 05
3999.00.00	619 460 06 05	4495.00.00	000 460 93 05	4533.00.00	001 460 04 05
3999.00.00	619 460 21 05	4495.00.00	001 460 69 05	4534.00.00	667 460 15 05
3999.00.00	619 460 47 05	4496.00.00	942 330 00 03	4534.00.00	667 460 17 05
4450.00.00	941 330 00 03	4496.00.00	942 330 01 03	4535.00.00	668 460 21 05
4450.00.00	941 330 01 03	4496.00.00	942 330 02 03	4535.00.00	668 460 22 05
4450.00.00	941 330 02 03	4496.00.00	942 330 07 03	4536.00.00	631 460 07 05
4450.00.00	941 330 03 03	4496.00.00	942 330 11 03	4539.00.00	002 460 49 05
4451.00.00	945 330 02 03	4504.00.00	001 460 62 05	4539.00.00	002 460 50 05
4451.00.00	945 330 03 03	4504.00.00	002 460 12 05	4541.00.00	002 460 63 05
4451.00.00	945 330 05 03	4505.00.00	001 460 89 05	4545.00.00	001 460 05 05
4457.00.00	942 330 03 03	4505.00.00	002 460 13 05	4545.00.00	001 460 06 05
4457.00.00	942 330 04 03	4510.00.00	001 460 63 05	4546.00.00	619 460 20 05
4457.00.00	942 330 16 03	4510.00.00	001 460 85 05	4546.00.00	619 460 46 05
4458.00.00	625 330 03 03	4511.00.00	949 330 12 03	4548.00.00	001 460 15 05
4458.00.00	625 330 20 03	4511.00.00	949 330 13 03	4548.00.00	001 460 73 05
4458.00.00	625 330 21 03	4511.00.00	949 330 18 03	4548.00.00	375 460 16 05
4458.00.00	625 330 26 03	4512.00.00	396 460 53 05	4549.00.00	002 460 51 05
4458.00.00	625 330 27 03	4513.00.00	972 460 18 05	4549.00.00	002 460 52 05
4458.00.00	942 330 05 03	4513.00.00	972 460 20 05	4550.00.00	424 330 03 03
4458.00.00	942 330 06 03	4514.00.00	970 460 07 05	4551.00.00	001 460 13 05
4458.00.00	942 330 09 03	4514.00.00	970 460 09 05	4551.00.00	001 460 14 05
4459.00.00	942 330 08 03	4515.00.00	001 460 86 05	4551.00.00	002 460 05 05
4459.00.00	949 330 02 03	4515.00.00	001 460 87 05	4551.00.00	003 460 32 05
4459.00.00	949 330 03 03	4516.00.00	080 460 67 05	4552.00.00	406 460 01 05
4459.00.00	949 330 09 03	4519.00.00	001 460 07 05	4553.00.00	945 330 00 03
4471.00.00	970 330 00 03	4519.00.00	001 460 08 05	4553.00.00	945 330 01 03
4471.00.00	970 330 01 03	4519.00.00	001 460 70 05	4553.00.00	945 330 04 03
4471.00.00	970 330 02 03	4522.00.00	949 330 10 03	4553.00.00	945 330 06 03
4471.00.00	970 330 03 03	4522.00.00	949 330 11 03	4554.00.00	000 460 43 05
4471.00.00	970 330 04 03	4522.00.00	949 330 17 03	4554.00.00	625 460 48 05
4474.00.00	975 330 02 03	4524.00.00	003 460 46 05	4558.20.00	001 460 15 48
4474.00.00	975 330 03 03	4524.00.00	974 460 10 05	4558.20.00	001 460 16 48
4474.00.00	975 330 08 03	4524.00.00	974 460 12 05	4559.00.00	949 330 04 03
4474.00.00	975 330 17 03	4525.00.00	002 460 96 05	4559.00.00	949 330 05 03
4480.00.00	942 350 10 05	4525.00.00	002 460 97 05	4559.00.00	949 330 08 03

FAD broj	Originalni broj	FAD broj	Originalni broj	FAD broj	Originalni broj
4559.00.00	949 330 14 03	5521.96.00	000 330 07 07	5728.00.00	302 460 05 05
4560.00.00	427 460 00 05	5522.96.00	357 330 00 35	5728.00.00	302 460 06 05
4560.00.00	427 460 01 05	5536.20.00	699 460 16 48	5728.00.00	302 460 39 05
4560.00.00	427 460 03 05	5631.00.00	675 460 13 05	5728.00.00	302 460 40 05
4560.00.00	427 460 04 05	5631.00.00	675 460 19 05	5728.00.00	373 460 06 05
4561.00.00	972 460 15 05	5631.00.00	675 460 25 05	5728.00.00	373 460 09 05
4561.00.00	972 460 17 05	5631.00.00	675 460 31 05	5729.00.00	317 460 67 05
4562.00.00	970 460 08 05	5703.00.00	602 330 09 03	5730.00.00	385 330 01 03
4562.00.00	970 460 10 05	5703.00.00	602 330 10 03	5730.00.00	385 330 12 03
4563.00.00	001 460 98 05	5703.00.00	602 330 53 03	5730.00.00	385 330 19 03
4563.00.00	001 460 99 05	5703.00.00	602 330 54 03	5730.00.00	385 330 20 03
4563.00.00	002 460 64 05	5704.00.00	309 330 06 03	5731.00.00	343 330 01 03
4564.00.00	676 460 12 05	5704.00.00	309 330 07 03	5731.00.00	343 330 03 03
4564.00.00	676 460 16 05	5704.00.00	309 330 08 03	5731.00.00	343 330 04 03
4565.00.00	974 460 11 05	5704.00.00	309 330 11 03	5733.10.00	000 330 11 35
4565.00.00	974 460 13 05	5705.00.00	381 350 06 06	5733.20.00	000 338 16 10
4566.00.00	629 350 12 06	5705.00.00	652 350 03 06	5733.20.00	001 330 10 35
4566.00.00	629 350 28 06	5705.00.00	653 350 01 06	5733.20.00	001 330 12 35
4567.00.00	625 330 32 03	5705.96.00	000 350 11 05	5733.20.00	001 330 14 35
4567.00.00	944 330 17 03	5706.00.00	654 350 04 06	5734.00.00	383 460 14 05
4568.00.00	001 460 11 05	5706.00.00	654 350 05 06	5737.00.00	314 330 03 03
4568.00.00	002 460 04 05	5706.00.00	654 352 00 05	5739.00.00	395 320 15 32
4569.96.00	000 330 20 11	5708.00.00	356 350 01 06	5740.00.00	352 460 22 05
4746.20.00	000 330 12 35	5718.00.00	317 460 65 05	5740.00.00	352 460 30 05
4746.20.00	000 330 13 35	5718.00.00	317 460 66 05	5740.00.00	352 460 58 05
4746.20.00	000 330 98 35	5718.00.00	317 460 70 05	5741.00.00	385 330 05 03
5117.96.00	000 330 02 07	5718.00.00	317 460 72 05	5741.00.00	385 330 06 03
5128.96.00	000 330 05 11	5719.00.00	317 460 61 05	5741.00.00	385 330 11 03
5128.96.00	000 330 22 11	5720.00.00	316 460 06 05	5741.00.00	385 330 14 03
5170.96.00	000 350 05 06	5720.00.00	316 460 07 05	5741.00.00	385 330 15 03
5280.00.00	307 460 04 05	5720.00.00	316 460 08 05	5741.10.00	000 330 01 48
5282.00.00	305 330 04 03	5720.00.00	316 460 09 05	5741.10.00	001 330 88 35
5282.00.00	305 330 08 03	5721.00.00	302 460 16 05	5741.10.00	302 330 00 35
5282.00.00	305 330 10 03	5721.00.00	302 460 18 05	5741.10.00	302 330 01 35
5282.00.00	305 330 11 03	5721.00.00	302 460 24 05	5741.10.00	302 330 02 35
5283.00.00	300 460 06 05	5721.00.00	302 460 37 05	5741.10.00	302 330 03 35
5283.00.00	300 460 07 05	5721.00.00	302 460 38 05	5741.10.00	350 330 71 35
5283.00.00	305 460 03 05	5721.00.00	373 460 08 05	5741.20.00	000 330 02 48
5323.96.00	000 330 07 07	5722.00.00	373 460 03 05	5741.20.00	000 330 32 35
5363.00.00	670 460 26 05	5722.00.00	373 460 05 05	5741.20.00	000 338 34 10
5363.00.00	670 460 27 05	5722.00.00	373 460 07 05	5741.20.00	000 460 83 48
5365.00.00	670 460 08 05	5722.00.00	373 460 35 05	5741.20.00	000 463 34 29
5365.00.00	670 460 12 05	5722.00.00	373 460 36 05	5741.20.00	001 330 01 35
5365.00.00	670 460 16 05	5724.00.00	317 460 63 05	5741.20.00	001 330 02 35
5365.00.00	670 460 20 05	5725.00.00	302 330 09 03	5741.20.00	001 460 44 48
5367.96.00	000 350 20 05	5725.00.00	302 330 13 03	5742.20.00	000 460 01 48
5369.10.00	000 460 78 48	5725.00.00	302 330 15 03	5742.20.00	000 460 26 48
5369.10.00	001 460 20 48	5725.00.00	302 330 17 03	5742.20.00	000 460 27 48
5369.20.00	000 460 77 48	5727.00.00	302 460 33 05	5743.00.00	371 330 70 03
5369.20.00	001 460 21 48	5727.00.00	302 460 34 05	5743.00.00	393 330 00 03

FAD broj	Originalni broj	FAD broj	Originalni broj	FAD broj	Originalni broj
5743.00.00	393 330 02 03	5774.20.00	000 460 85 48	5799.00.00	385 460 20 05
5743.00.00	393 330 03 03	5774.20.00	310 330 04 35	5799.00.00	385 460 34 05
5743.00.00	393 330 04 03	5774.20.00	310 330 08 35	5804.00.00	352 330 19 03
5743.10.00	000 460 06 48	5774.20.00	310 330 13 35	5804.00.00	352 330 20 03
5743.10.00	000 460 12 48	5775.00.00	309 460 03 05	5804.00.00	352 330 23 03
5743.10.00	000 460 34 48	5775.00.00	309 460 04 05	5804.00.00	352 330 24 03
5743.10.00	000 460 35 48	5775.00.00	309 460 05 05	5805.00.00	353 330 03 03
5743.10.00	001 460 14 48	5775.00.00	309 460 08 05	5805.00.00	353 330 04 03
5743.20.00	000 460 03 48	5775.00.00	309 460 09 05	5805.00.00	353 330 05 03
5743.20.00	000 460 28 48	5775.00.00	309 460 10 05	5805.00.00	353 330 06 03
5743.20.00	000 460 29 48	5775.00.00	309 460 11 05	5805.10.00	000 330 02 35
5743.20.00	001 460 22 48	5775.00.00	309 460 12 05	5805.10.00	000 330 07 35
5746.10.00	000 330 33 35	5775.00.00	309 460 13 05	5805.10.00	000 330 68 35
5746.10.00	000 330 72 35	5775.00.00	309 460 14 05	5805.10.00	000 330 86 35
5746.10.00	000 330 94 35	5775.00.00	309 460 20 05	5805.10.00	000 330 88 35
5746.10.00	000 330 96 35	5775.00.00	309 460 22 05	5805.20.00	000 330 03 35
5746.20.00	000 330 14 35	5775.00.00	309 460 23 05	5805.20.00	000 330 06 35
5746.20.00	000 330 15 35	5775.00.00	309 460 24 05	5805.20.00	000 330 85 35
5746.20.00	000 330 93 35	5775.00.00	309 460 25 05	5805.20.00	000 330 87 35
5746.20.00	000 330 95 35	5775.00.00	309 460 26 05	5805.20.00	000 463 32 29
5747.00.00	358 330 01 03	5775.00.00	309 460 29 05	5806.00.00	327 330 01 03
5747.00.00	358 330 05 03	5775.00.00	309 460 30 05	5806.00.00	327 330 03 03
5747.00.00	381 330 03 03	5775.00.00	309 460 31 05	5806.00.00	327 330 04 03
5747.00.00	381 330 05 03	5775.00.00	309 460 32 05	5806.00.00	352 330 02 03
5747.00.00	381 330 06 03	5775.00.00	601 460 00 05	5806.00.00	358 330 00 03
5747.00.00	381 330 07 03	5775.00.00	601 460 01 05	5806.00.00	358 330 07 03
5748.00.00	383 460 08 05	5775.00.00	601 460 02 05	5806.00.00	358 330 08 03
5748.00.00	383 460 16 05	5775.00.00	601 460 03 05	5807.00.00	346 330 29 03
5748.00.00	383 460 24 05	5776.00.00	314 460 03 05	5807.00.00	346 330 43 03
5748.00.00	383 460 45 05	5777.00.00	314 460 08 05	5807.00.00	346 330 44 03
5748.20.00	000 330 31 35	5778.00.00	327 460 00 05	5811.00.00	387 460 07 05
5748.20.00	000 330 81 35	5779.00.00	352 460 33 05	5811.00.00	387 460 14 05
5748.20.00	001 330 03 35	5779.00.00	360 460 02 05	5811.00.00	387 460 32 05
5748.20.00	001 330 04 35	5779.00.00	360 460 08 05	5811.00.00	387 460 33 05
5749.00.00	387 460 04 05	5779.00.00	360 460 21 05	5811.00.00	647 460 00 05
5749.00.00	387 460 50 05	5783.38.00	317 330 05 11	5811.00.00	647 460 01 05
5749.00.00	620 460 00 05	5785.38.00	305 330 06 11	5812.00.00	387 460 06 05
5749.00.00	620 460 20 05	5786.38.00	302 330 03 11	5812.00.00	387 460 44 05
5749.00.00	620 460 28 05	5792.00.00	363 460 00 05	5812.00.00	387 460 45 05
5749.00.00	620 460 37 05	5792.00.00	363 460 06 05	5814.00.00	352 330 17 03
5770.00.00	381 350 02 06	5792.00.00	363 460 07 05	5814.00.00	352 330 25 03
5770.00.00	383 350 00 06	5793.00.00	387 460 00 05	5814.00.00	352 330 27 03
5771.00.00	389 320 07 32	5793.00.00	387 460 48 05	5816.00.00	352 460 21 05
5772.00.00	389 320 08 32	5793.00.00	387 460 49 05	5816.00.00	352 460 29 05
5773.00.00	385 350 00 06	5794.00.00	302 460 06 05	5816.00.00	352 460 46 05
5773.00.00	653 350 00 06	5794.00.00	302 460 14 05	5816.00.00	352 460 55 05
5774.20.00	000 330 50 35	5794.00.00	302 460 20 05	5817.00.00	343 330 01 03
5774.20.00	000 460 21 48	5797.10.00	000 330 08 35	5817.00.00	343 330 03 03
5774.20.00	000 460 41 48	5797.20.00	000 330 09 35	5817.00.00	343 330 04 03
5774.20.00	000 460 45 48	5799.00.00	385 460 08 05	5818.00.00	352 330 18 03

FAD broj	Originalni broj	FAD broj	Originalni broj	FAD broj	Originalni broj
5818.00.00	352 330 26 03	5837.00.00	302 330 09 03	5852.00.00	601 460 11 05
5818.00.00	352 330 28 03	5837.00.00	302 330 13 03	5852.00.00	601 460 12 05
5820.00.00	343 460 04 05	5837.00.00	302 330 15 03	5852.00.00	601 460 13 05
5820.00.00	343 460 08 05	5837.00.00	302 330 17 03	5852.00.00	601 460 15 05
5820.00.00	343 460 10 05	5839.00.00	387 460 07 05	5854.00.00	307 330 01 11
5820.00.00	343 460 12 05	5839.00.00	387 460 14 05	5854.00.00	357 330 36 11
5820.00.00	343 460 14 05	5839.00.00	387 460 32 05	5854.90.00	000 586 09 32
5820.00.00	343 460 15 05	5839.00.00	387 460 33 05	5855.10.00	000 460 58 48
5821.00.00	617 460 00 05	5839.00.00	647 460 00 05	5855.10.00	000 460 61 48
5821.00.00	617 460 02 05	5839.00.00	647 460 01 05	5855.10.00	000 460 69 48
5821.00.00	617 460 28 05	5840.00.00	352 350 03 06	5855.10.00	000 460 71 48
5822.00.00	620 460 01 05	5842.00.00	395 350 02 06	5855.10.00	001 460 05 48
5822.00.00	620 460 21 05	5842.00.00	659 350 01 06	5855.10.00	001 460 13 48
5822.00.00	620 460 38 05	5842.00.00	659 350 24 06	5855.20.00	000 460 57 48
5822.00.00	620 460 39 05	5843.00.00	307 460 00 05	5855.20.00	000 460 60 48
5823.00.00	316 330 02 03	5843.00.00	307 460 05 05	5855.20.00	000 460 68 48
5823.00.00	316 330 06 03	5844.00.00	395 350 06 06	5855.20.00	000 460 70 48
5823.00.00	316 330 07 03	5845.00.00	395 350 10 06	5855.20.00	000 460 75 48
5825.00.00	327 460 06 05	5845.00.00	624 350 02 06	5855.20.00	001 460 11 48
5825.00.00	327 460 16 05	5845.00.00	659 350 13 06	5855.20.00	001 460 17 48
5826.00.00	310 330 07 03	5845.00.00	659 350 36 06	5855.20.00	001 460 24 48
5826.00.00	310 330 09 03	5846.00.00	381 350 06 06	5855.20.00	001 460 76 48
5826.00.00	310 330 11 03	5846.00.00	652 350 03 06	5856.20.00	001 330 18 35
5826.00.00	730 505	5846.00.00	653 350 01 06	5858.00.00	620 350 00 06
5826.00.00	730 600	5846.90.00	000 586 10 35	5858.00.00	620 350 01 06
5827.00.00	310 330 06 03	5847.90.00	000 350 10 13	5858.00.00	655 350 03 06
5827.00.00	310 330 08 03	5848.10.00	000 330 19 35	5860.00.00	387 460 15 05
5827.00.00	310 330 10 03	5848.10.00	000 330 29 35	5860.00.00	387 460 35 05
5827.00.00	310 330 12 03	5848.10.00	000 330 41 35	5860.00.00	387 460 36 05
5828.00.00	669 330 04 03	5848.10.00	000 330 78 35	5860.00.00	647 460 02 05
5828.00.00	669 330 05 03	5848.10.00	000 338 50 29	5860.00.00	647 460 03 05
5828.00.00	670 330 00 03	5848.10.00	001 330 22 35	5862.00.00	302 330 11 03
5828.00.00	670 330 01 03	5848.10.00	001 330 27 35	5862.00.00	302 330 14 03
5828.00.00	670 330 02 03	5848.20.00	000 330 40 35	5862.00.00	302 330 16 03
5828.00.00	670 330 03 03	5848.20.00	000 330 49 29	5863.00.00	676 330 08 03
5829.00.00	676 330 02 03	5848.20.00	000 330 77 35	5863.00.00	676 330 10 03
5829.00.00	676 330 04 03	5848.20.00	001 330 21 35	5864.00.00	620 330 05 03
5829.00.00	676 330 07 03	5848.20.00	001 330 26 35	5864.00.00	620 330 06 03
5829.00.00	676 330 09 03	5849.00.00	654 350 04 06	5865.00.00	357 460 04 05
5831.00.00	673 460 03 05	5849.00.00	654 350 05 06	5865.00.00	357 460 10 05
5831.00.00	673 460 05 05	5849.00.00	654 352 00 05	5865.00.00	357 460 11 05
5831.00.00	673 460 07 05	5851.00.00	620 350 00 06	5866.00.00	677 330 03 03
5831.00.00	673 460 09 05	5851.00.00	620 350 01 06	5866.00.00	677 330 04 03
5835.00.00	300 460 04 05	5851.00.00	655 350 03 06	5869.00.00	385 330 04 03
5835.00.00	300 460 05 05	5852.00.00	601 460 05 05	5869.00.00	385 330 19 03
5835.00.00	301 460 05 05	5852.00.00	601 460 06 05	5869.00.00	385 330 20 03
5836.00.00	620 330 03 03	5852.00.00	601 460 07 05	5871.00.00	346 330 39 03
5836.00.00	620 330 04 03	5852.00.00	601 460 08 05	5871.00.00	346 330 49 03
5836.00.00	620 330 07 03	5852.00.00	601 460 09 05	5872.00.00	391 330 06 03
5836.00.00	620 330 08 03	5852.00.00	601 460 10 05	5872.00.00	391 330 08 03

FAD broj	Originalni broj	FAD broj	Originalni broj	FAD broj	Originalni broj
5872.00.00	391 330 10 03	5897.10.00	310 330 19 35	6885.00.00	628 333 00 03
5872.00.00	391 330 12 03	5897.10.00	310 330 23 35	6885.00.00	628 333 00 05
5873.00.00	387 460 15 05	5897.10.00	310 330 27 35	6885.00.00	628 333 10 05
5873.00.00	387 460 35 05	5897.20.00	310 330 02 35	6885.00.00	628 333 18 05
5873.00.00	387 460 36 05	5897.20.00	310 330 18 35	6887.00.00	000 460 41 05
5873.00.00	647 460 02 05	5897.20.00	310 330 22 35	6887.00.00	000 460 55 05
5873.00.00	647 460 03 05	5897.20.00	310 330 26 35	6887.00.00	625 460 42 05
5874.00.00	625 330 04 03	5899.20.00	000 463 23 29	6887.00.00	625 460 78 05
5875.00.00	300 460 02 05	5899.20.00	000 463 26 29	6900.00.00	671 460 02 05
5875.00.00	300 460 03 05	5900.20.00	000 463 24 29	6901.00.00	357 330 11 03
5875.00.00	301 460 00 05	5900.20.00	000 463 25 29	6901.00.00	357 330 15 03
5875.00.00	301 460 01 05	5904.20.00	000 460 49 48	6902.00.00	357 460 32 05
5881.00.00	317 460 57 05	5905.00.00	000 460 28 05	6902.00.00	671 460 03 05
5881.00.00	317 460 58 05	5905.00.00	000 460 36 05	6904.00.00	671 333 01 05
5882.00.00	317 460 69 05	5905.00.00	000 460 51 05	6905.00.00	357 333 05 05
5882.00.00	317 460 71 05	5905.00.00	625 460 43 05	6905.00.00	671 333 02 05
5885.00.00	360 460 03 05	5905.00.00	625 460 77 05	6906.00.00	357 333 07 05
5885.00.00	360 460 09 05	5906.00.00	000 460 39 05	6906.00.00	671 333 04 05
5885.00.00	360 460 22 05	5906.00.00	625 460 38 05	6910.00.00	357 330 19 11
5886.00.00	602 330 00 03	5906.00.00	625 460 43 05	6910.00.00	357 330 33 11
5886.00.00	602 330 01 03	5906.00.00	625 460 52 05	7385.20.00	440 460 03 48
5886.00.00	602 330 03 03	5906.00.00	625 460 79 05	7414.20.00	000 330 56 35
5886.00.00	602 330 04 03	5907.00.00	625 460 25 05	7414.20.00	000 338 18 10
5886.00.00	602 330 55 03	5944.96.00	000 350 28 05	7414.20.00	000 460 43 48
5886.10.00	601 330 05 35	5956.00.00	357 333 02 05	7414.20.00	000 460 56 48
5886.20.00	601 330 04 35	5976.00.00	357 330 06 03	7414.20.00	310 330 06 35
5887.00.00	305 460 06 05	5976.00.00	357 330 07 03	7414.20.00	310 330 10 35
5887.00.00	357 460 12 05	6021.96.00	000 350 10 05	7414.20.00	310 330 12 35
5887.00.00	357 460 13 05	6023.96.00	000 350 25 05	7523.20.00	000 463 40 29
5888.00.00	673 460 02 05	6039.00.00	357 333 04 05	7523.20.00	000 463 41 29
5888.00.00	673 460 04 05	6050.00.00	356 330 00 03		
5888.00.00	673 460 06 05	6050.00.00	613 330 00 03		
5888.00.00	673 460 08 05	6051.00.00	356 330 02 03		
5889.00.00	001 460 96 05	6052.00.00	356 463 02 15		
5890.00.00	617 460 32 05	6053.00.00	356 463 00 15		
5890.00.00	617 460 33 05	6053.00.00	613 463 00 15		
5891.00.00	385 350 00 06	6054.00.00	356 330 01 03		
5891.00.00	653 350 00 06	6054.00.00	613 330 01 03		
5893.00.00	305 460 04 05	6197.00.00	629 350 05 06		
5895.20.00	602 330 02 35	6197.00.00	629 350 06 06		
5895.20.00	602 330 03 35	6407.00.00	945 350 01 05		
5896.10.00	310 330 01 35	6407.00.00	948 350 25 05		
5896.10.00	310 330 16 35	6409.96.00	444 333 01 27		
5896.10.00	310 330 21 35	6881.00.00	002 460 43 05		
5896.10.00	310 330 25 35	6881.00.00	002 460 44 05		
5896.20.00	310 330 00 35	6881.20.00	001 460 42 48		
5896.20.00	310 330 17 35	6881.20.00	001 460 50 48		
5896.20.00	310 330 20 35	6881.20.00	001 460 85 48		
5896.20.00	310 330 24 35	6882.00.00	002 460 45 05		
5897.10.00	310 330 03 35	6882.00.00	002 460 46 05		

FAD broj	Originalni broj
3573.00.00	665 197
3576.00.00	678 612
3579.00.00	665 196
3581.00.00	660 915
3581.10.00	660 916
3581.20.00	660 917
3582.00.00	660 856
3583.00.00	832 45
3584.00.00	660 977
3585.00.00	900 20
3586.00.00	660 976
3587.00.00	665 178
3588.00.00	900 81
3593.00.00	685 201
3595.00.00	683 795
3597.00.00	699 432
3598.00.00	700 875
3599.00.00	737 710
3646.00.00	917 20
4333.00.00	837 57
4333.00.00	839.53.3143.000
4334.00.00	A4815-20
4335.00.00	A4815-21
4336.00.00	A4815-22
4337.00.00	783.24.3143.000
4337.00.00	863 97
4345.00.00	4922-02/1962
4345.00.00	918 42
4387.00.00	996 56
4440.00.00	143 929
4441.00.00	144 228
5198.00.00	832.00.3183.000
5741.10.00	678 621
5741.20.00	678 622
5743.10.00	660 857
5743.20.00	660 858
5746.10.00	654 136
5914.00.00	836.01.3504.000
5927.00.00	997 324
5928.00.00	377 740
7720.20.00	619 687

FAD broj	Originalni broj	FAD broj	Originalni broj	FAD broj	Originalni broj
3282.00.00	50 10 094 840	4675.00.00	50 10 145 584	5743.20.00	50 00 288 360
3283.00.00	00 00 691 970	4675.00.00	50 10 439 631	5743.20.00	50 00 590 236
3284.00.00	50 10 025 292	4676.00.00	50 10 308 082	5743.20.00	50 00 804 824
3284.96.00	50 00 814 841	4676.00.00	50 10 566 059	5743.20.00	77 01 011 412
3285.00.00	50 10 005 937	4677.00.00	50 10 216 608	5746.10.00	50 00 559 336
3286.00.00	50 10 197 399	4678.00.00	50 10 395 796	5746.10.00	50 00 823 947
3287.00.00	50 10 207 168	4678.00.00	50 10 566 049	5746.10.00	50 00 823 997
3288.00.00	50 10 207 771	4679.00.00	50 00 613 837	5752.00.00	50 10 145 077
3289.00.00	00 23 123 220	4680.00.00	50 10 308 214	5755.00.00	00 23 123 237
3289.00.00	1 151 394	4680.00.00	50 10 439 984	5755.00.00	1 151 395
3291.00.00	50 10 130 344	4681.00.00	50 10 439 022	5755.00.00	23 123 237
3292.00.00	50 00 785 429	4681.20.00	50 01 858 763	5755.96.00	50 00 802 123
3293.00.00	00 23 123 247	4682.00.00	50 10 439 021	5757.00.00	00 23 123 238
3293.00.00	50 00 748 868	4682.00.00	50 10 566 063	5757.00.00	1 151 396
3293.00.00	50 00 874 577	4683.00.00	50 10 587 004	5757.00.00	23 123 238
3293.00.00	50 10 130 453	4683.00.00	50 10 600 822	5759.00.00	00 23 123 265
3296.00.00	50 00 725 267	4684.00.00	50 10 630 822	5760.00.00	00 23 123 225
3296.00.00	50 10 144 549	4684.00.00	50 10 630 823	5760.00.00	00 23 123 240
3296.00.00	50 10 144 552	4685.00.00	50 10 587 034	5760.00.00	23 123 225
3297.00.00	50 10 060 764	4685.00.00	50 10 587 038	5760.00.00	23 123 240
3297.00.00	50 10 557 243	4686.00.00	50 10 600 483	5760.00.00	50 01 826 368
3298.00.00	00 23 123 247	4687.00.00	50 10 630 812	5805.10.00	50 00 807 553
3298.00.00	50 00 748 868	4687.00.00	50 10 630 813	5805.10.00	50 00 814 096
3298.00.00	50 00 874 577	4688.00.00	7420 761 145	5805.10.00	50 01 844 135
3298.00.00	50 10 130 453	4690.00.00	50 10 094 839	5805.20.00	00 03 406 252
3590.20.00	00 23 162 046	5170.96.00	50 01 842 823	5805.20.00	50 00 807 554
3590.20.00	50 00 516 214	5524.90.00	50 01 014 520	5805.20.00	50 00 814 097
3590.20.00	50 10 144543	5741.10.00	00 03 406 213	5805.20.00	50 01 844 136
3637.96.00	50 01 840 095	5741.10.00	00 03 406 218	5856.10.00	00 03 401 206
3698.90.00	77 01 011 267	5741.10.00	50 00 295 215	5856.10.00	50 01 832 579
3944.00.00	50 10 207 726	5741.10.00	50 01 850 550	5856.20.00	00 03 401 207
3945.00.00	50 10 207 727	5741.10.00	50 01 852 263	5856.20.00	50 01 831 481
3948.00.00	50 10 037 602	5741.20.00	00 03 406 212	5856.20.00	50 01 832 580
3948.00.00	50 10 037 603	5741.20.00	00 03 406 253	5910.00.00	50 00 027 957
3948.00.00	50 10 130 456	5741.20.00	50 00 242 159	5910.00.00	50 00 810 038
4660.00.00	50 00 786 532	5741.20.00	50 00 295 214	5980.00.00	00 00 566 157
4661.00.00	00 23 123 262	5741.20.00	50 00 812 483	5981.00.00	00 00 745 019
4666.00.00	23 123 224	5741.20.00	50 01 850 549	5982.00.00	00 23 123 253
4666.00.00	50 10 145 077	5741.20.00	77 01 016 946	5983.00.00	00 23 123 252
4667.00.00	720 128	5742.20.00	50 00 808 458	5983.00.00	50 00 788 392
4668.00.00	50 10 294 288	5742.20.00	77 01 002 911	5985.00.00	00 23 123 253
4669.00.00	50 10 294 289	5743.10.00	00 03 401 170	5985.00.00	50 00 750 976
4670.00.00	50 10 294 287	5743.10.00	50 00 288 361	5985.00.00	50 00 783 574
4672.00.00	50 01 860 359	5743.10.00	50 01 832 581	5985.00.00	50 01 850 530
4673.00.00	50 00 145 581	5743.20.00	00 03 406 169	5985.00.00	50 10 064 641
4673.00.00	50 00 791 032	5743.20.00	00 03 406 236	5985.00.00	50 10 094 838
4673.00.00	50 10 308 215	5743.20.00	00 03 406 251	5985.00.00	50 10 094 941
4673.00.00	50 10 791 275	5743.20.00	00 03 406 254	5987.00.00	00 23 123 159
4674.00.00	50 10 145 078	5743.20.00	00 03 406 260	5992.96.00	50 00 819 365
4675.00.00	50 10 098 467	5743.20.00	00 03 406 261	5992.96.00	50 10 104 465

FAD/RENAULT



FAD broj	Originalni broj	
5993.00.00	00 23 123 275	
5994.00.00	50 10 268 035	
5995.00.00	23 123 256	
5996.00.00	00 23 123 233	
5998.10.00	00 03 401 150	
5998.10.00	50 00 803 462	
5998.20.00	00 03 401 149	
5998.20.00	50 00 803 461	
6359.00.00	50 10 097 562	
7474.20.00	50 00 792 132	
7762.00.00	50 10 566 058	

FAD broj	Originalni broj	FAD broj	Originalni broj
3081.00.00	390 784	5810.10.00	352 645
3082.00.00	1 384 025	5810.20.00	1 337 367
3082.00.00	1 768 898	5810.20.00	352 646
3083.00.00	1 338 769	5847.96.00	638 861
3083.00.00	1 428 347	6409.96.00	550 808
3084.00.00	1 326 775	6830.00.00	1 334 139
3087.00.00	1 304 569	6831.00.00	1 399 180
3089.20.00	1 383 405	6832.00.00	1 361 413
3126.00.00	1 397 866	6832.00.00	1 395 614
3126.00.00	1 734 020	6832.00.00	1 734 019
3126.00.00	395 350	6832.00.00	1 897 333
3138.00.00	414 531	6832.20.00	1 357 674
3148.00.00	278 665	6833.00.00	1 385 251
3149.00.00	306 981	6833.00.00	1 409 918
3343.00.00	1 379 423	6833.00.00	1 501 030
3348.00.00	345 124	6833.00.00	1 723 895
3361.00.00	445 599	6833.00.00	1 737 683
3361.00.00	489 989	6833.00.00	1 897 335
3362.00.00	465 816	6834.00.00	1 897 673
3362.00.00	466 801	6834.00.00	475 463
3362.00.00	489 987	6835.00.00	1 343 266
3363.00.00	621 863	6835.00.00	1 759 690
3363.96.00	638 860	6836.00.00	388 943
3364.00.00	649 346	6837.00.00	421 573
3365.00.00	651 156	6838.00.00	1 343 283
3366.00.00	651 157	6838.00.00	1 759 691
3367.00.00	651 158	6839.00.00	1 308 643
3368.00.00	409 639	6840.00.00	291 396
3369.00.00	417 290	6841.00.00	1 393 298
3581.20.00	1 337 367	6842.00.00	1 324 890
4126.20.00	1 488 890	6843.00.00	1 420 698
4126.20.00	1 534 756	6844.00.00	483 527
5048.96.00	114 406	6847.00.00	1 384 027
5170.96.00	1 104 335	6847.00.00	1 769 597
5170.96.00	638 862	6849.00.00	1 394 884
5170.96.00	639 287	6851.00.00	1 766 015
5323.96.00	1 104 334	6851.00.00	445 626
5323.96.00	550 806	6852.20.00	1 357 674
5323.96.00	639 370	6853.00.00	445 629
5587.96.00	1 104 336	7523.20.00	1 376 902
5743.10.00	1 358 792	7981.20.00	1 394 443
5743.10.00	1 738 380	7982.20.00	1 394 444
5743.10.00	283 783		
5743.10.00	395 009		
5743.20.00	1 358 793		
5743.20.00	1 738 381		
5743.20.00	1 767 328		
5743.20.00	283 784		
5743.20.00	395 010		
5810.10.00	1 337 366		

FAD broj	Originalni broj	FAD broj	Originalni broj	FAD broj	Originalni broj
3071.00.00	1 576 092	4229.00.00	6 777 855	5596.20.00	3 090 727
3074.00.00	1 576 092	4232.00.00	3 173 614	5596.20.00	3 092 472
3074.00.00	1 606 283	4233.20.00	3 093 647	5596.20.00	3 988 965
3075.00.00	1 592 939	4240.00.00	6 777 705	5597.00.00	1 135 427
3075.00.00	85 114 144	4490.96.00	3 198 309	5597.90.00	113 50 30
3546.10.00	1 505 758	4746.20.00	1696 920	5598.00.00	1 606 551
3546.10.00	1 507 822	5121.90.00	271 188	5598.00.00	8 154 016
3546.10.00	1 698 533	5136.00.00	1 626 494	5599.00.00	1 135 427
3546.10.00	1 698 847	5140.00.00	6 771 112	5746.10.00	1 517 439
3546.20.00	1 505 759	5141.00.00	1 075 663	5746.10.00	1 698 190
3546.20.00	1 507 823	5141.00.00	20 393 069	5746.20.00	1 517 440
3546.20.00	1 698 532	5141.00.00	3 988 704	5746.20.00	1 517 444
3546.20.00	1 698 846	5323.96.00	271 187	5746.20.00	1 698 191
3590.20.00	6 027 074	5386.96.00	273 612	5805.10.00	1 517 448
3590.20.00	6 853 913	5388.90.00	1 134 955	5805.20.00	1 190 778
3744.96.00	274 068	5493.00.00	1 197 338	5805.20.00	1 517 449
4200.00.00	3 962 843	5494.00.00	20 490 123	5805.20.00	1 518 142
4208.00.00	3 124 964	5494.00.00	20 745 923	5943.90.00	273 706
4208.00.00	6 799 190	5494.00.00	21 308 022	5945.90.00	273 375
4208.20.00	1 697 246	5494.00.00	9 519 278	6260.00.00	20 739 082
4208.20.00	1 698 047	5524.90.00	3 133 173	6260.00.00	70 311 664
4209.00.00	3 116 050	5580.90.00	1 075 255	6261.00.00	20 497 798
4210.00.00	8 132 373	5580.90.00	1 591 689	6261.00.00	3 112 050
4211.00.00	3 039 647	5580.90.00	20 554 908	6261.00.00	9 959 151
4212.00.00	1 611 880	5580.90.00	3 173 759	6262.00.00	20 443 063
4212.00.00	1 626 670	5581.90.00	1 598 588	6262.00.00	20 443 067
4216.00.00	1 094 219	5584.00.00	1 589 817	6262.00.00	20 994 420
4218.00.00	3 173 613	5586.00.00	20 556 490	6263.00.00	20 497 799
4218.00.00	3 987 354	5586.00.00	3 173 291	6263.00.00	3 112 273
4219.00.00	1 094 334	5586.90.00	1 628 107	6263.00.00	9 959 152
4219.00.00	1 575 690	5587.00.00	1 080 690	6264.00.00	1 071 344
4220.00.00	20 393 071	5587.00.00	1 606 200	6264.00.00	20 400 944
4220.00.00	8 190 146	5587.96.00	274 056	6264.00.00	3 127 737
4221.00.00	20 375 555	5587.96.00	276 192	6266.00.00	20 443 061
4221.00.00	20 393 186	5589.90.00	274 069	6266.00.00	20 443 065
4221.00.00	21 106 930	5594.00.00	1 581 527	6266.00.00	20 994 418
4221.00.00	3 986 452	5594.00.00	1 607 079	6267.00.00	20 374 831
4222.20.00	3 097 228	5594.00.00	8 154 017	6267.00.00	21 252 480
4222.20.00	3 099 529	5594.00.00	8 158 206	6268.00.00	20 393 187
4223.00.00	1 592 940	5594.00.00	8 158 207	6268.00.00	21 406 952
4223.00.00	85 114 145	5594.96.00	273 373	6720.00.00	20 367 004
4224.00.00	1 075 664	5594.96.00	274 019	6720.00.00	20 507 262
4224.00.00	20 393 063	5594.96.00	4 941 233	6720.00.00	20 741 695
4224.00.00	3 988 701	5595.00.00	1 610 338	6720.00.00	20 741 703
4225.00.00	1 629 668	5595.00.00	1 626 751	6720.00.00	7420 741 703
4225.00.00	20 477 805	5596.00.00	1 628 636	6721.00.00	20 382 314
4225.00.00	3 986 433	5596.00.00	85 114 200	6721.00.00	20 502 944
4229.00.00	20 400 909	5596.10.00	3 090 728	6723.00.00	20 556 490
4229.00.00	3 124 480	5596.10.00	3 110 001	6723.00.00	3 173 291
4229.00.00	3 124 594	5596.10.00	3 988 968	6725.00.00	1 075 005

FAD broj	Originalni broj	FAD broj	Originalni broj
6726.00.00	20 390 745	6762.20.00	382 745
6726.00.00	21 106 936	6765.00.00	1 130 568
6727.00.00	21 260 274	6767.00.00	6 853 511
6727.00.00	3 198 276	6768.00.00	1 088 985
6728.00.00	21 260 275	6768.00.00	20 393 083
6728.00.00	3 198 234	6769.00.00	1 626 637
6729.00.00	1 083 744	6769.00.00	3 962 343
6730.00.00	8 154 444	6769.00.00	3 988 711
6731.00.00	20 497 800	7720.00.00	1 576 093
6731.00.00	3 112 122	7720.00.00	1 606 284
6731.00.00	9 959 153	7720.10.00	1 695 840
6732.00.00	1 080 792	7720.20.00	1 507 826
6732.00.00	6 862 225	7720.20.00	1 695 585
6733.00.00	1 130 567	7720.20.00	1 695 776
6733.00.00	1 612 781	7720.20.00	1 698 557
6733.00.00	1 614 838		
6733.00.00	85 114 197		
6734.00.00	1 588 263		
6734.00.00	1 606 277		
6734.00.00	1 626 493		
6737.00.00	20 556 492		
6737.00.00	3 173 293		
6738.00.00	1 628 483		
6738.00.00	20 556 586		
6738.00.00	3 173 294		
6739.00.00	6 790 572		
6746.00.00	1 612 254		
6746.00.00	20 393 097		
6746.00.00	21 260 286		
6746.00.00	3 985 570		
6747.00.00	20 393 061		
6747.00.00	3 988 697		
6748.00.00	3 098 294		
6748.00.00	85 104 265		
6750.00.00	1 573 572		
6750.10.00	1 608 352		
6750.20.00	1 608 351		
6751.00.00	1 135 428		
6751.90.00	1 136 891		
6753.00.00	1 194 390		
6754.00.00	8 156 123		
6755.00.00	9 523 795		
6756.00.00	1 135 429		
6756.00.00	8 365 399		
6758.00.00	1 082 104		
6758.00.00	1 605 035		
6759.00.00	9 523 794		
6761.00.00	20 556 491		
6761.00.00	3 173 292		
6762.20.00	1 527 234		